

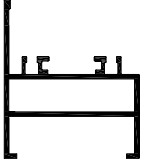









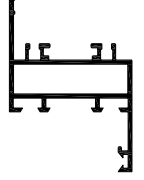
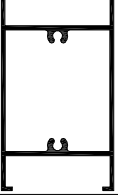
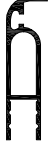

		GRILJE	LISTA PROFILA			401-01
Oznaka	Izgled-presjek	Težina kg/ml	Opseg mm	Ix cm ⁴	Wx cm ³	
P45-630		0.806	295			
P45-631		0.482	176			
P45-632		0.901	354			
P45-640		1.180	330			
P45-641		0.326	151			
P45-642		0.309	166			
P45-649		0.318	167			
F-0714		0.895	294			
F-0187		0.397	111			

		GRILJE	LISTA PROFILA			401-02
Oznaka	Izgled-presjek	Težina kg/ml	Opseg mm	Ix cm ⁴	Wx cm ³	
D45-074		0.570	195			
D45-075		0.451	215			
D45-081		0.530	174			
NC 1459		0.156	51			
F-0863		1.52	446.025			
F-0864		0.985	490.22			
F-0866		0.236	116.93			

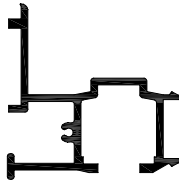
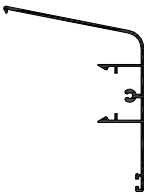

P45-630
težina kg/m 0.806
svj.povr.mm 101

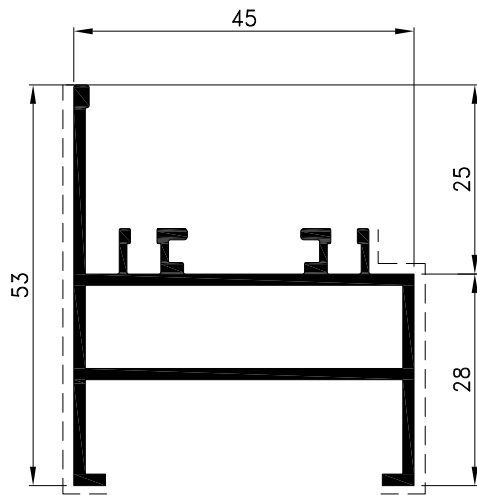
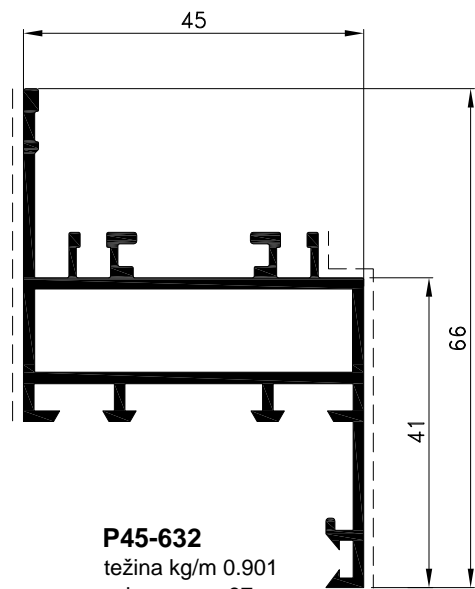

P45-632
težina kg/m 0.901
svj.povr.mm 97

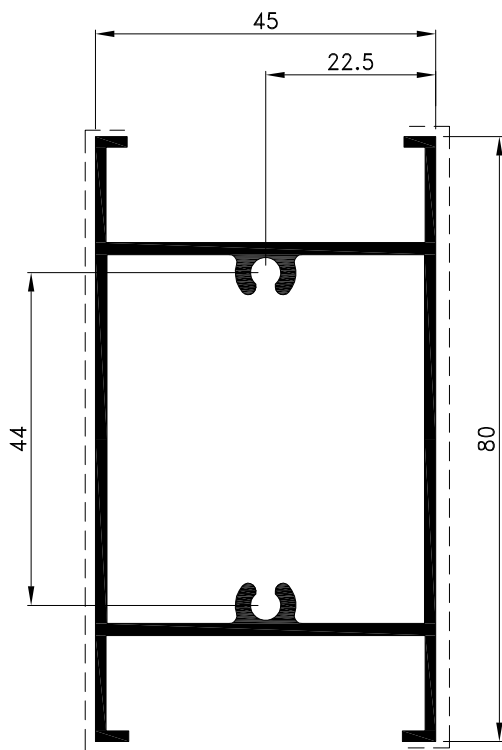

P45-640
težina kg/m 1.180
svj.povr.mm 176

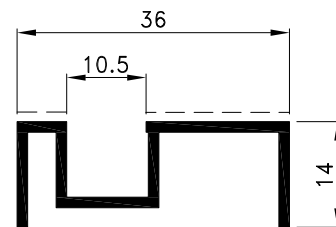

P45-642
težina kg/m 0.309
svj.povr.mm 26

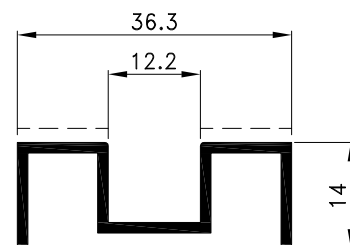

P45-649
težina kg/m 318
svj.povr.mm 24

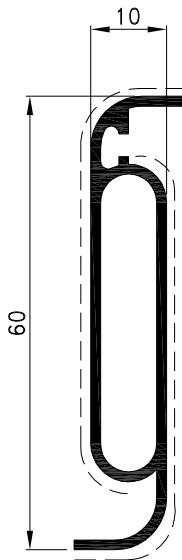

P45-631
težina kg/m 0.482
svj.povr.mm 122

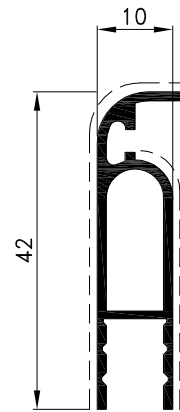

P45-641
težina kg/m 0.326
svj.povr.mm 85

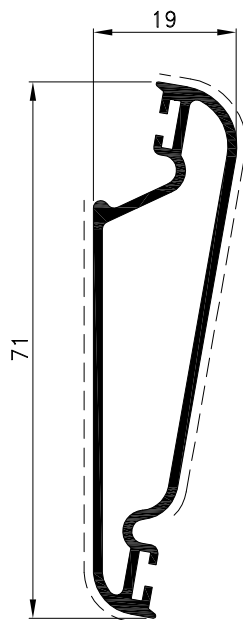

D45-074
težina kg/m 0.570
svj.povr.mm 129

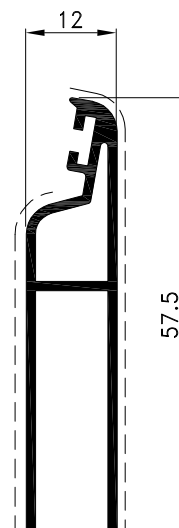

D45-075
težina kg/m 0.451
svj.povr.mm 109

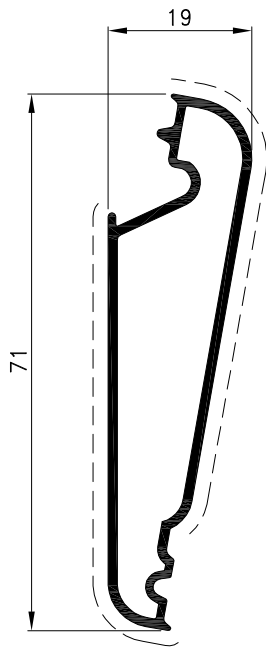

D45-081
težina kg/m 0.530
svj.povr.mm 129

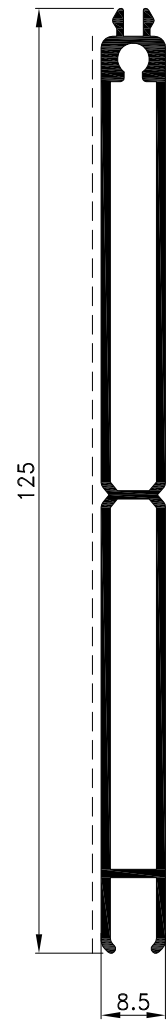

F-0714
težina kg/m 0.895
svj.povr.mm 85

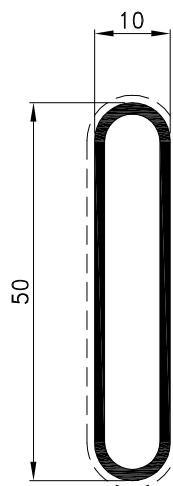

F-0187
težina kg/m 0.397
svj.povr.mm 118

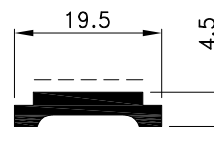

NC-1459
težina kg/m 0.156
svj.povr.mm 15

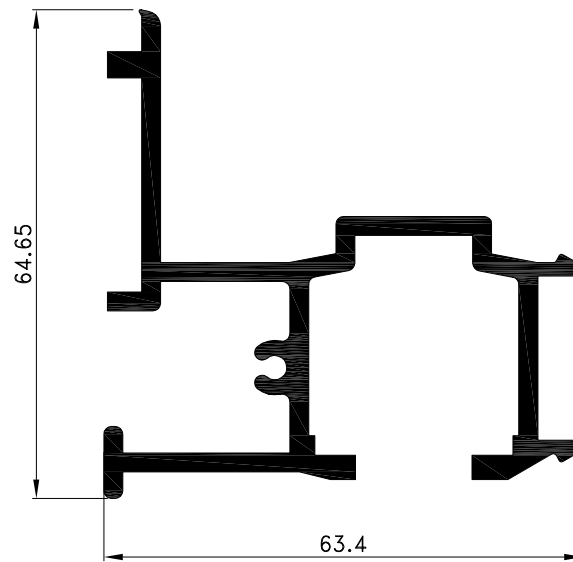

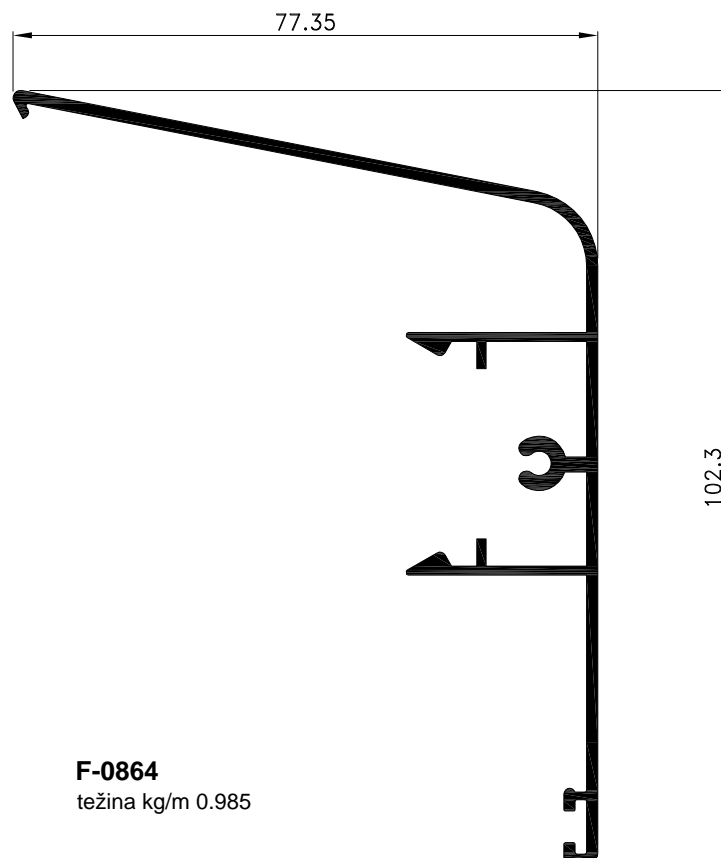

F-0863
težina kg/m 1.52



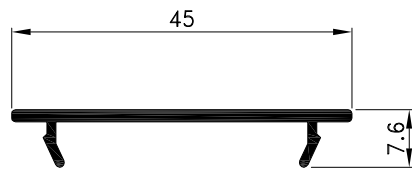

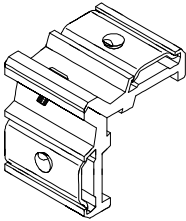
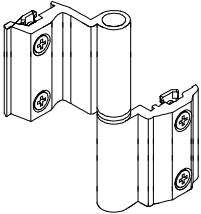
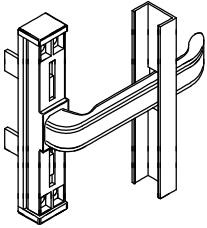
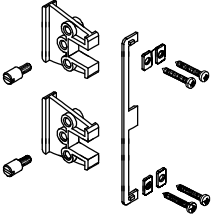
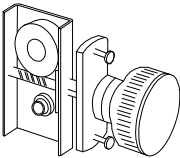
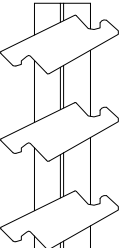

F-0864
težina kg/m 0.985

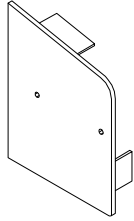
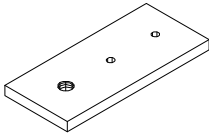
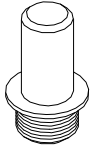
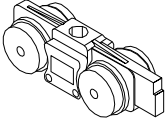
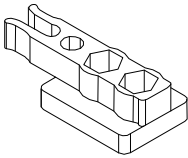

F-0866
težina kg/m 0.236

Oznaka	Izgled-presjek	Naziv	Materijal
0432		Kutnik	
A8521R		Šarka	
1004		Ručka	
2377		Vezni elementi ručke	
BBC		Ručica za pokretanje lamela	
SP-X		Mehanizam za lamele 35 mm	
2114		Zapinjač-nastavak klizača	

Oznaka	Izgled-presjek	Naziv	Materijal
BC-KG-01		Bočni čep	PVC
NP-G-01		Nosiva ploča	DURAL
UK-G-01		Donji usmjerivač krila	
1379		Kotačići za klizne grilje	
1380		Graničnik i ujedno prihvata krilo sa ublaživačem udara	

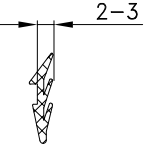
Oznaka	Izgled-presjek	Opis	Materijal	Težina g/ml
A 2000		Središnja brtva	EPDM	
A 2001		Središnja brtva	EPDM	
03866		Brtva na spoju lamela	EPDM	
01104-E		Brtva na spoju lamela	EPDM	
921		Brtva	EPDM	

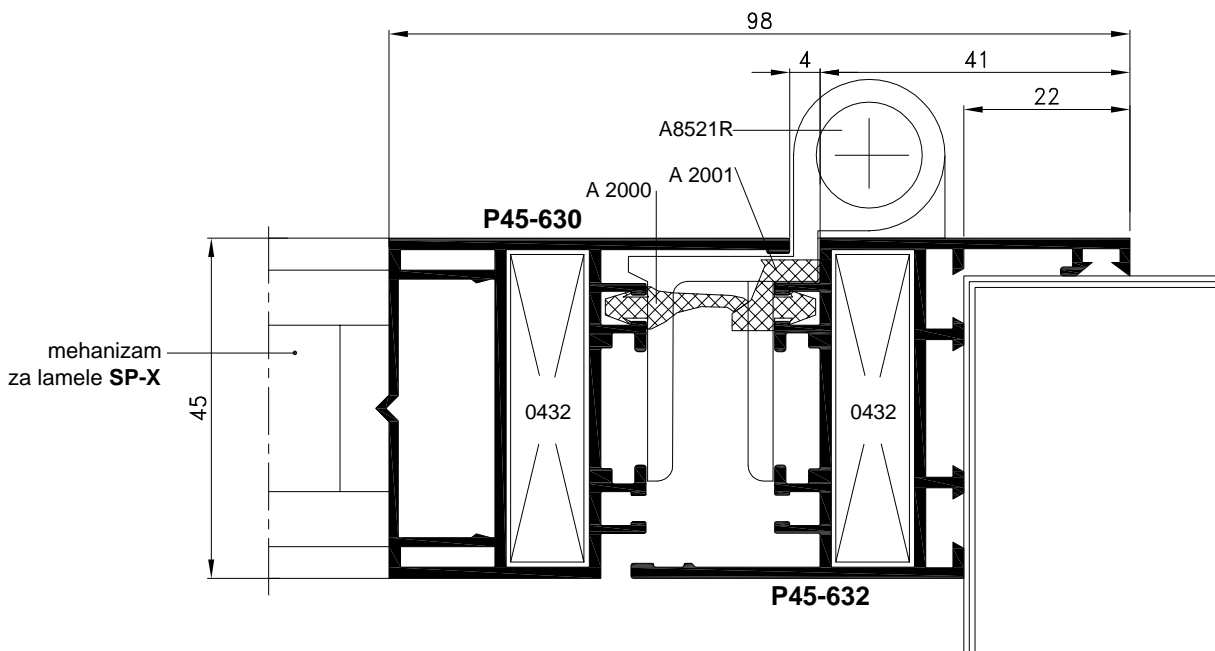
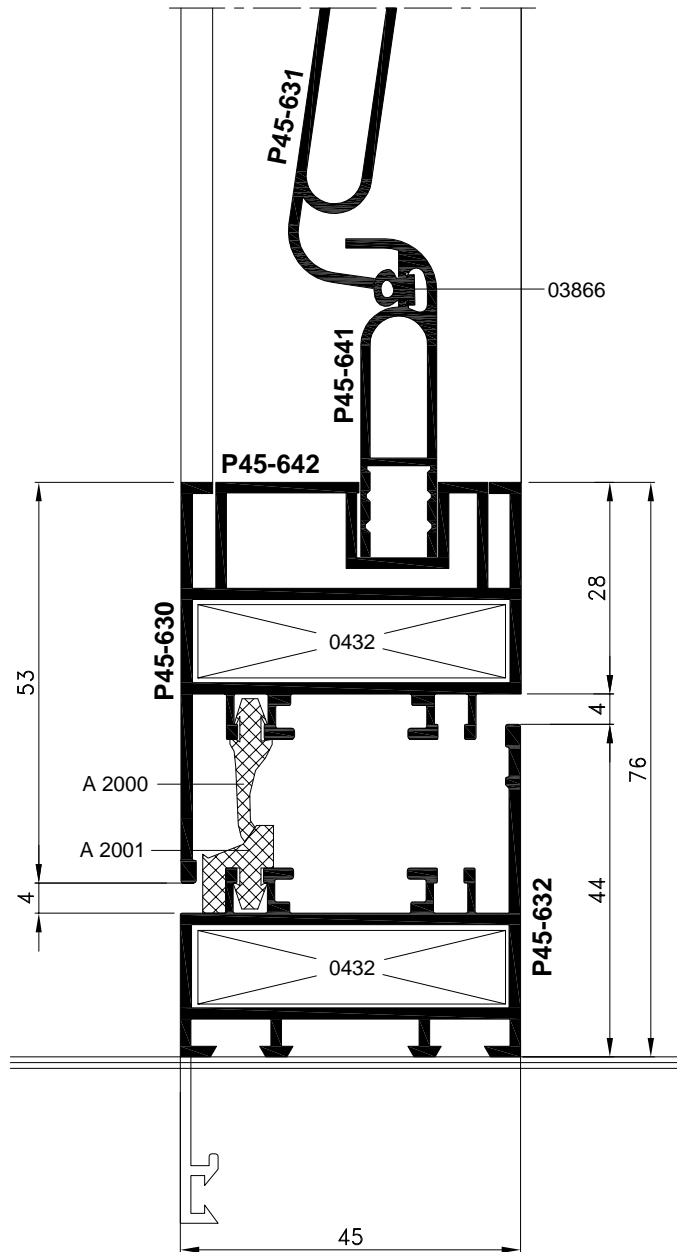
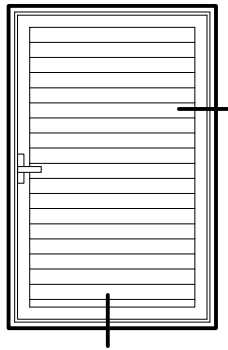

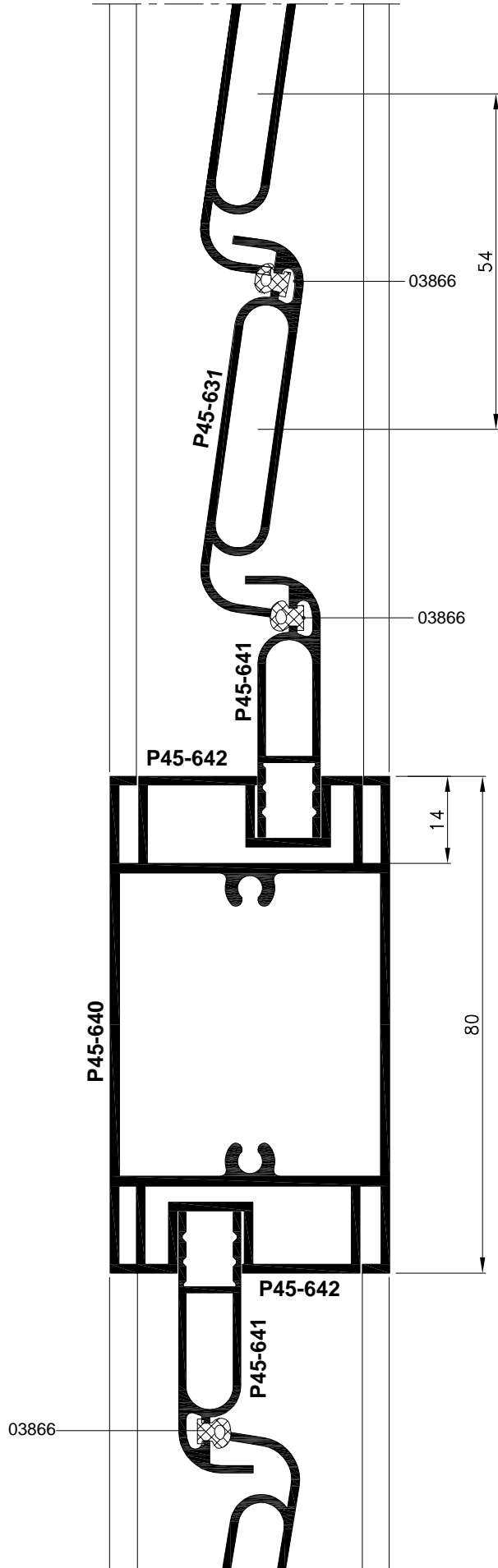
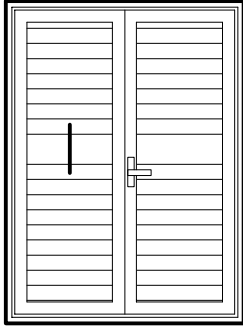

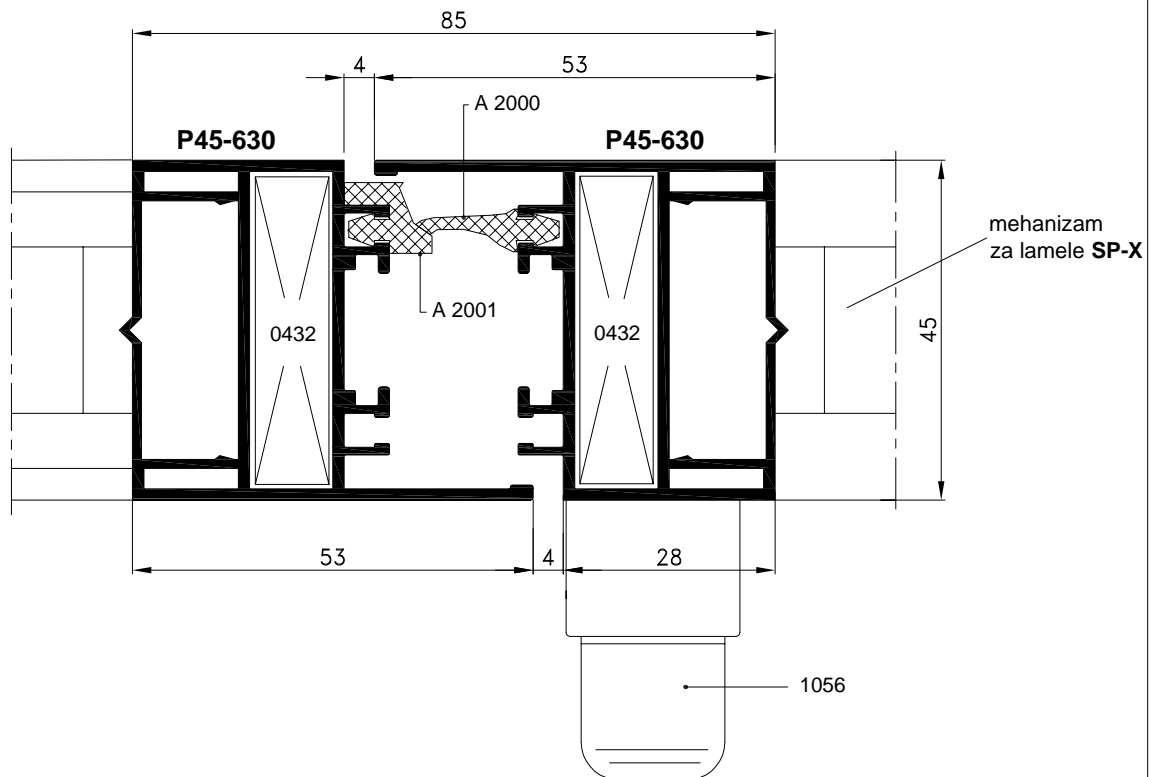
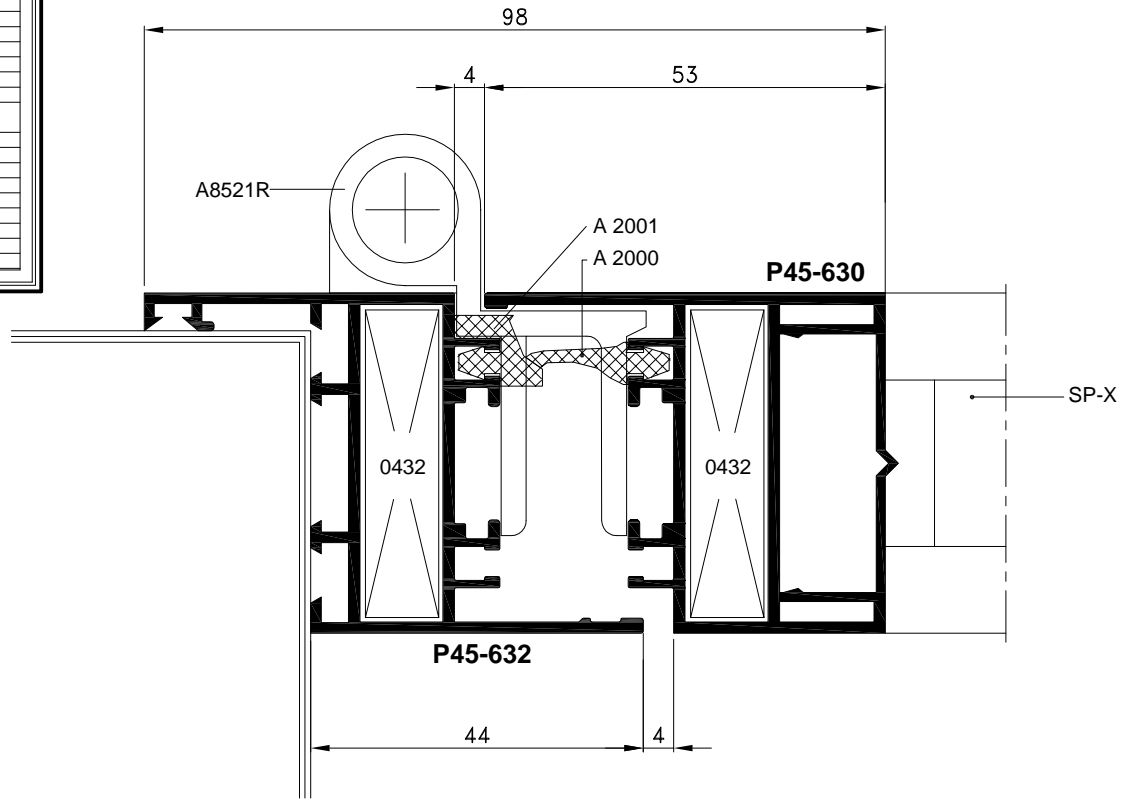
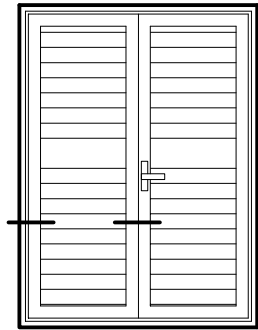



G 45

PRESJECI

405-04

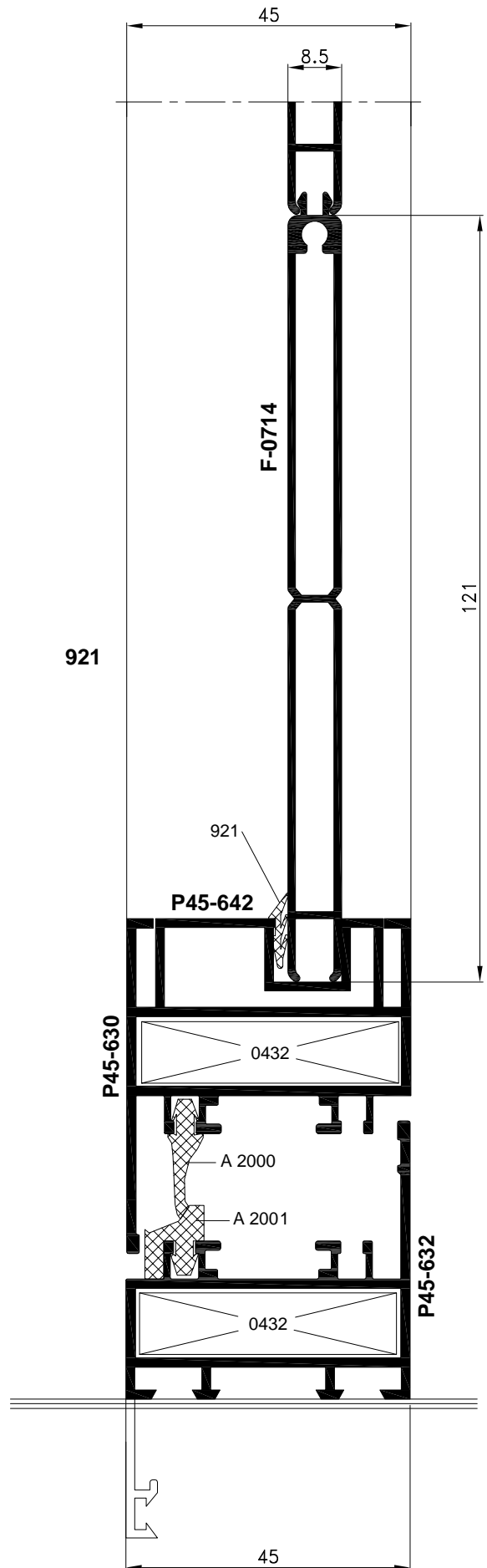
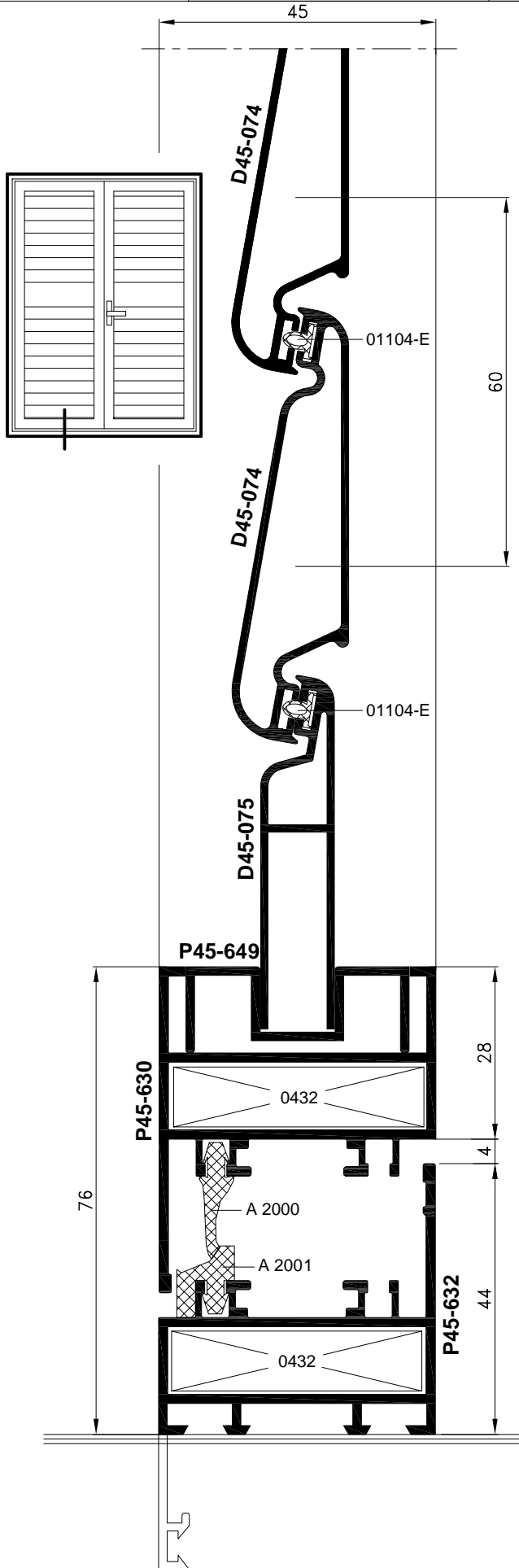

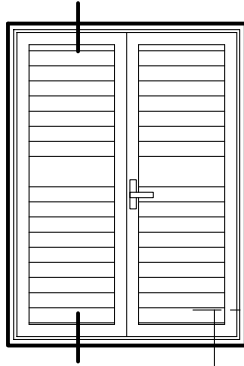

LAMELE BEZ BRTVE

- profil D45-081
- brtva se umeće samo u početnu gornju lamelu

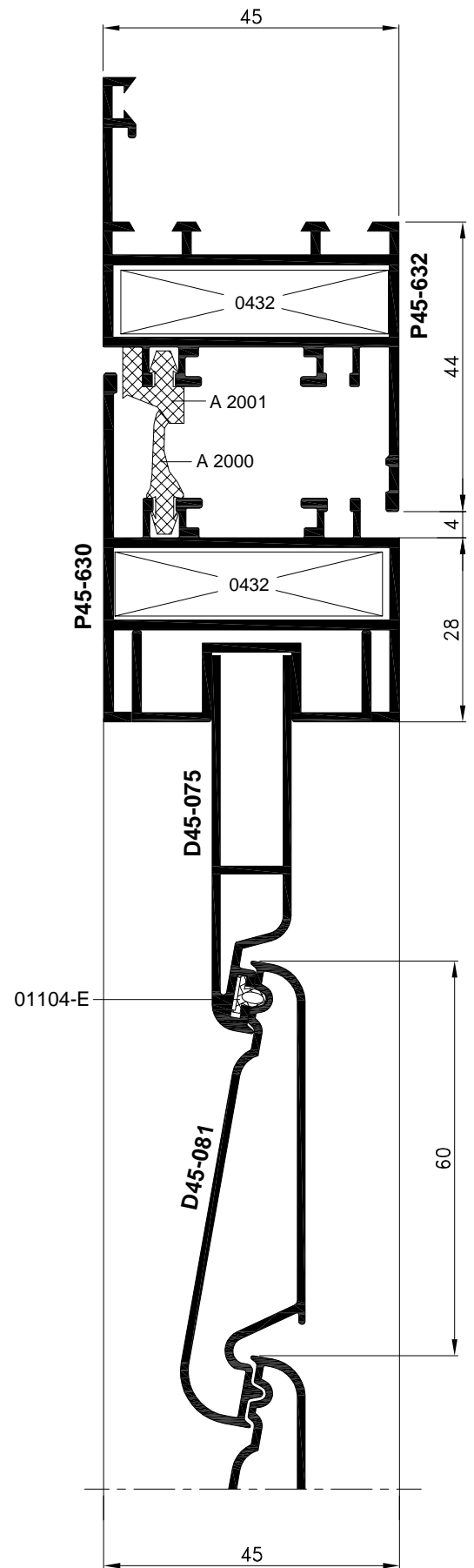
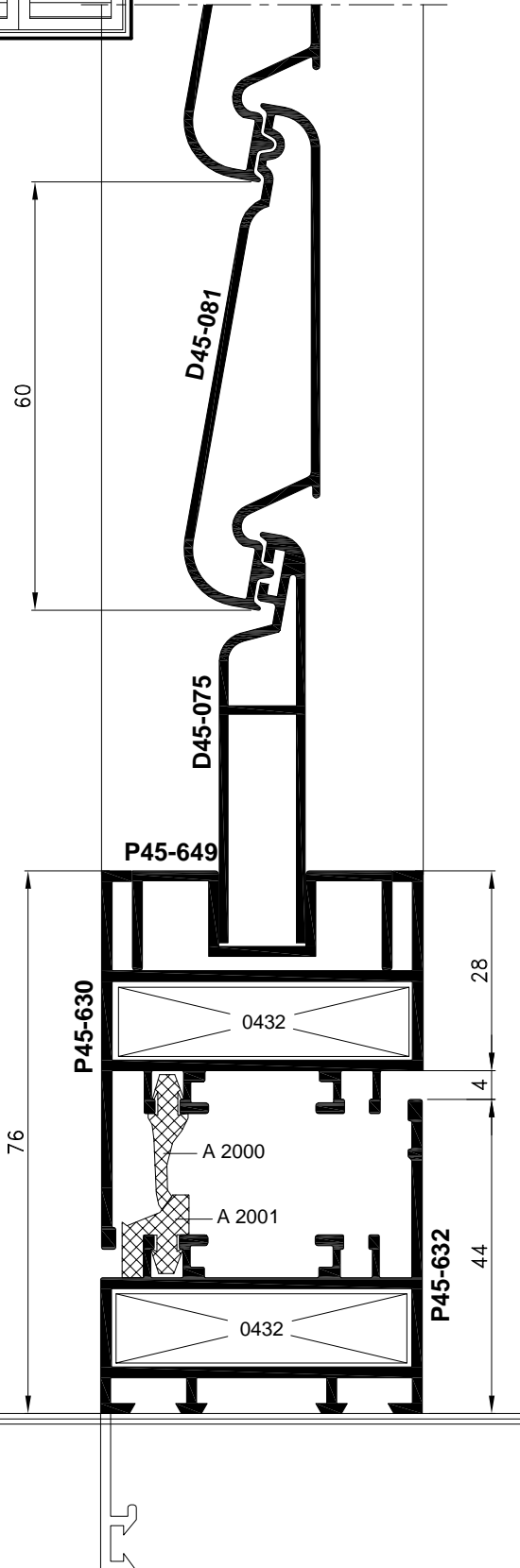

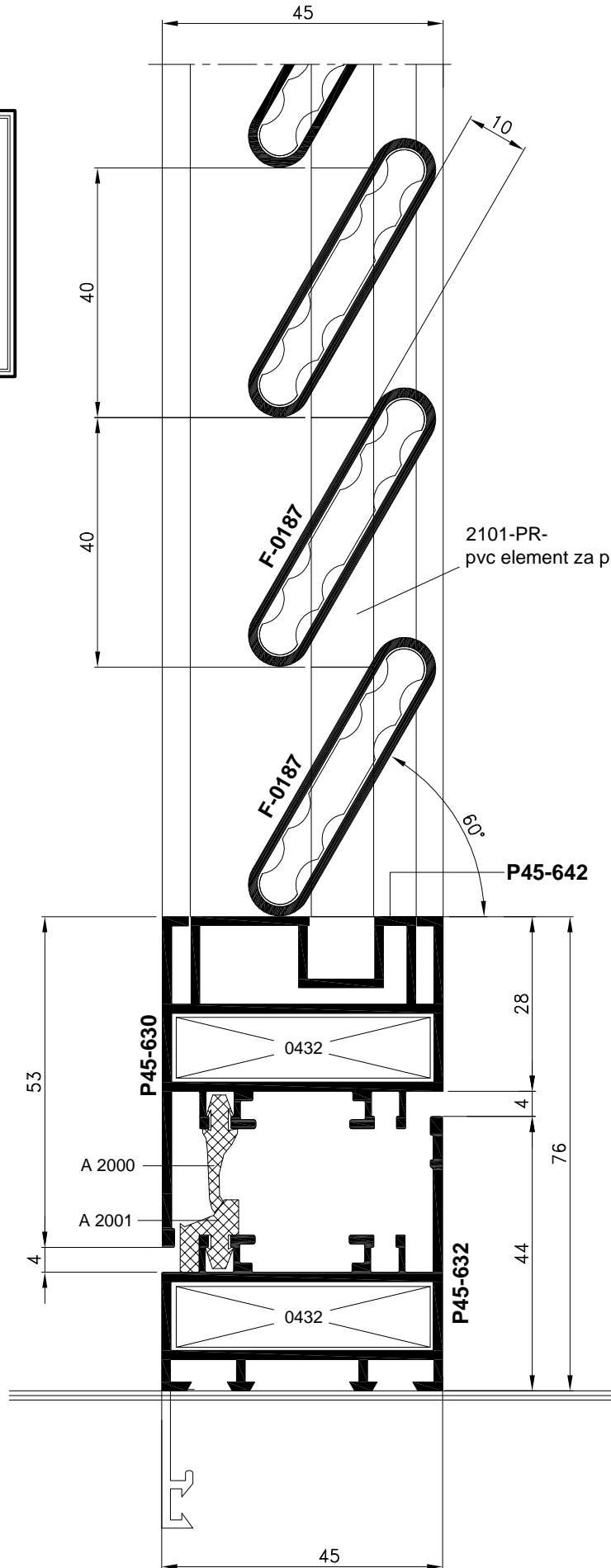
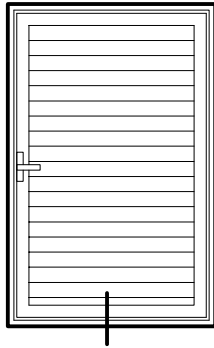

**GRILJA S FIKSNIM
LAMELAMA U KRILU**

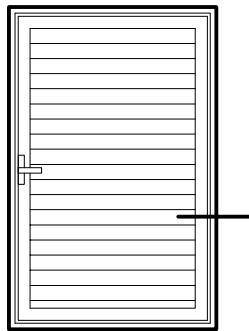

GRILJA S FIKSNIM
LAMELAMA U KRILU

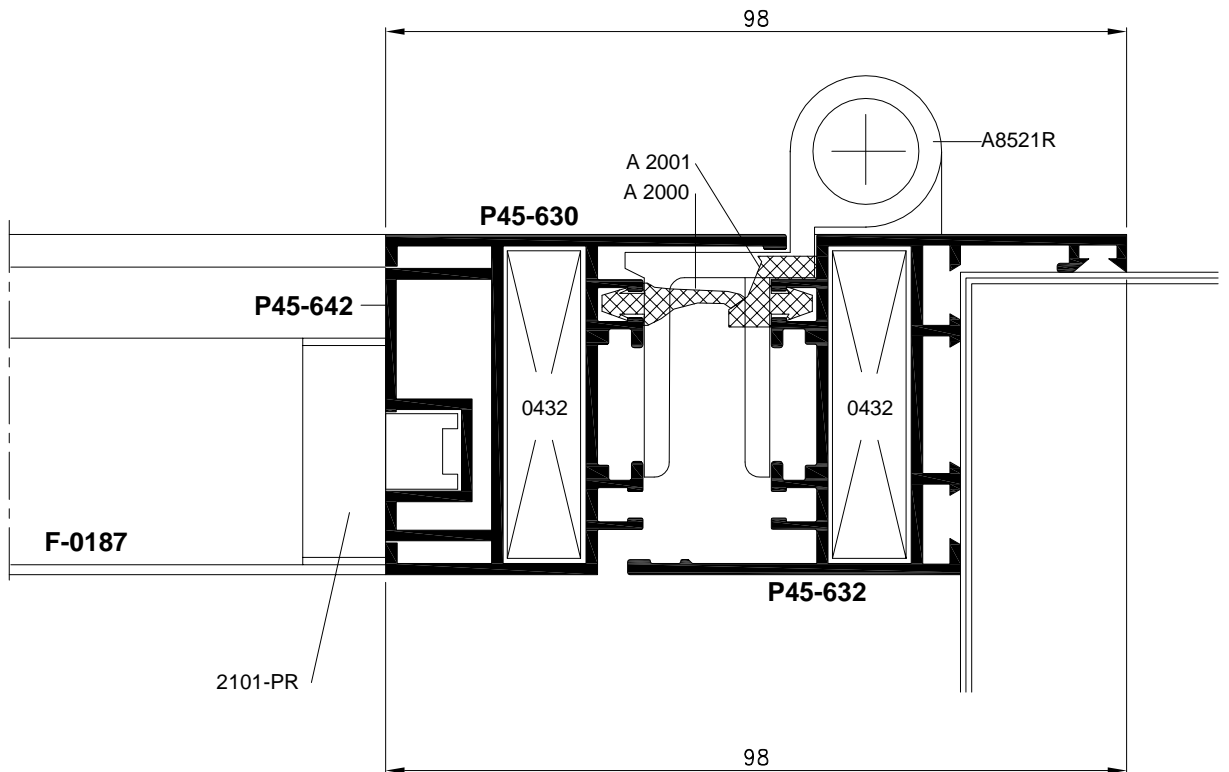

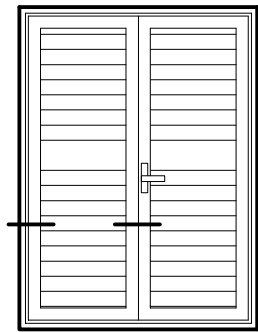

GRILJA S FIKSNIM
LAMELAMA U KRILU

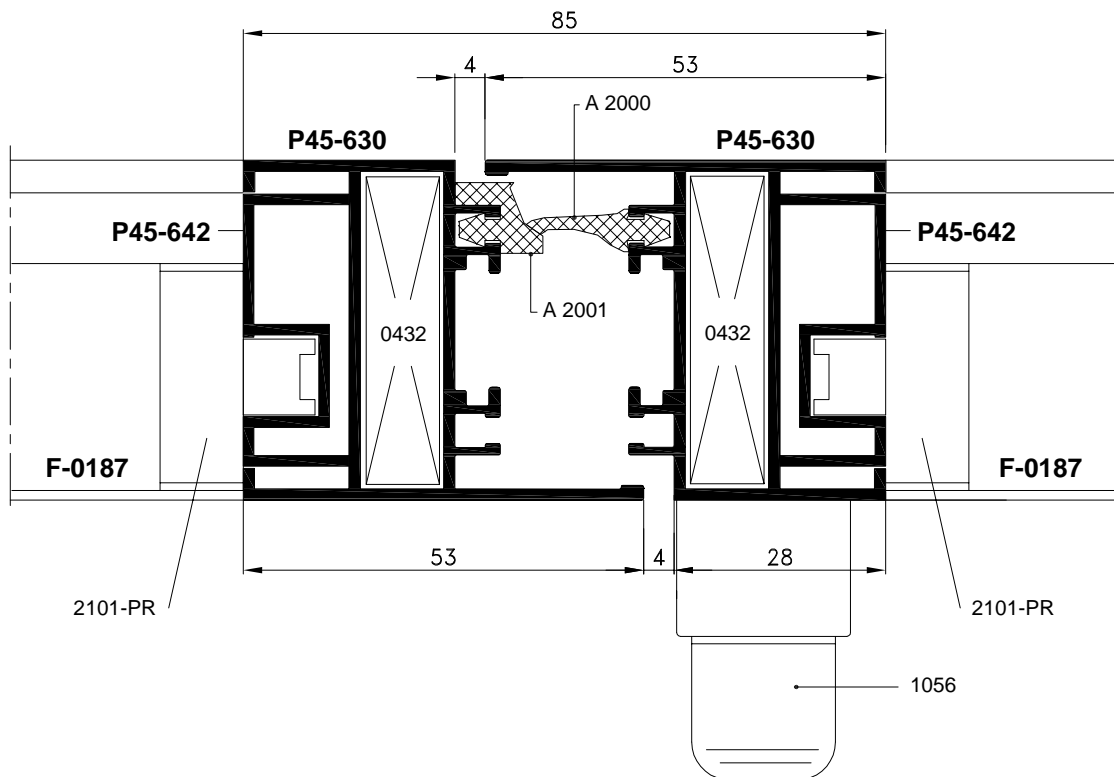
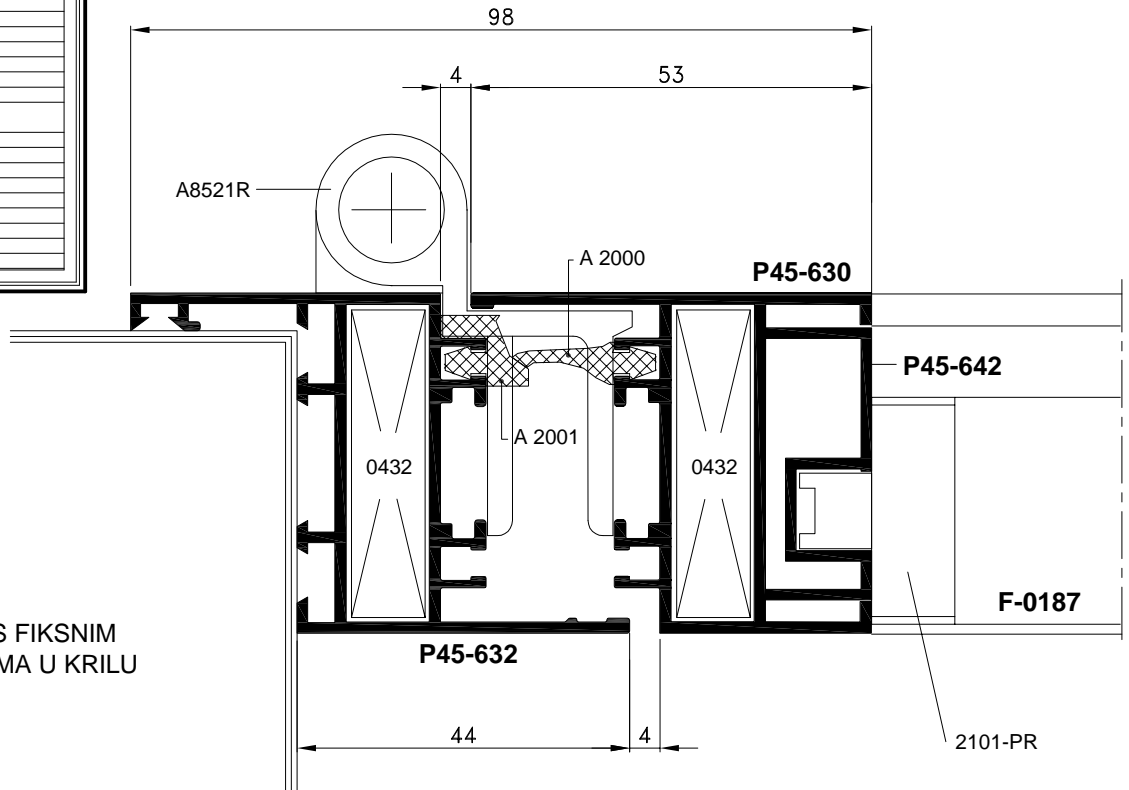

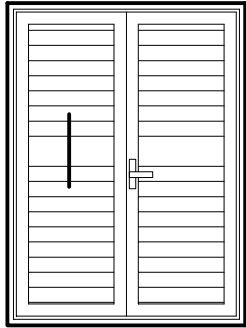

GRILJA S FIKSNIM
LAMELAMA U KRILU

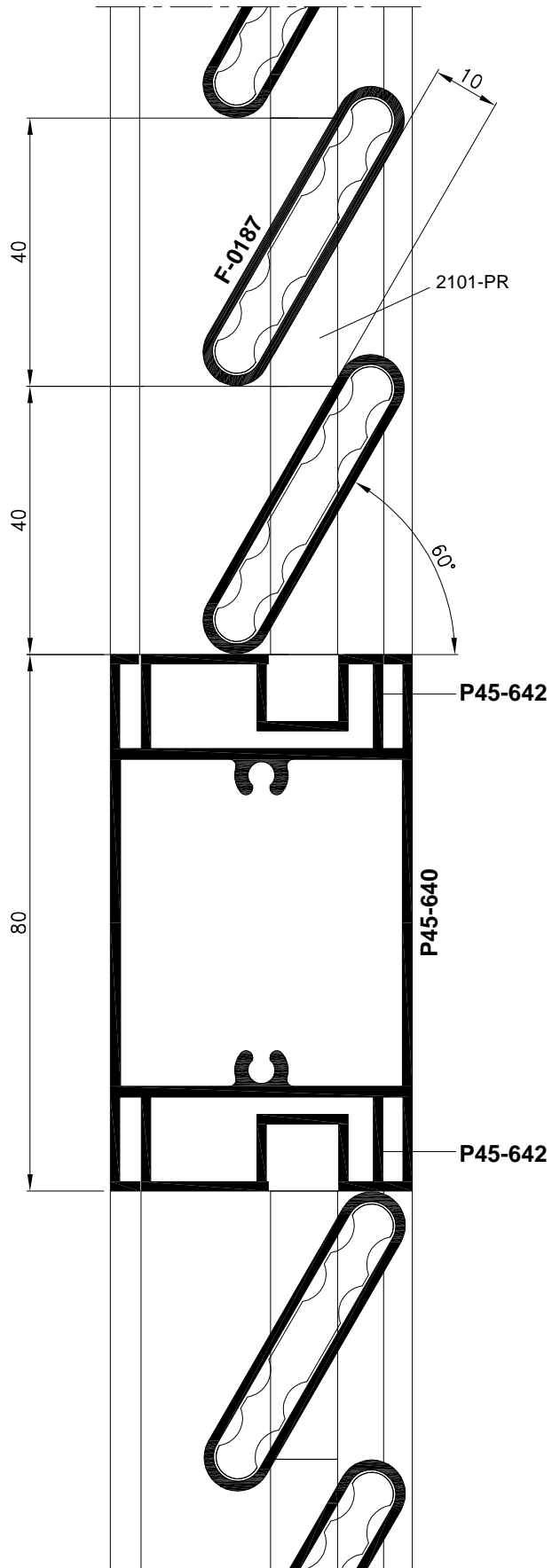

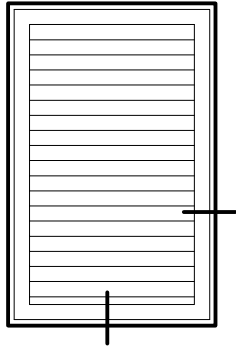

GRILJA S FIKSNIM
LAMELAMA U OKVIRU

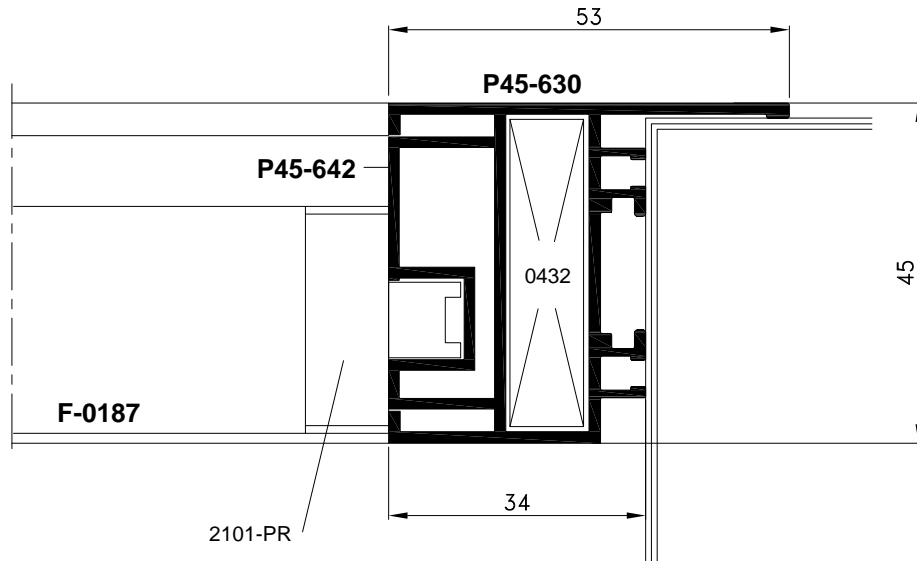
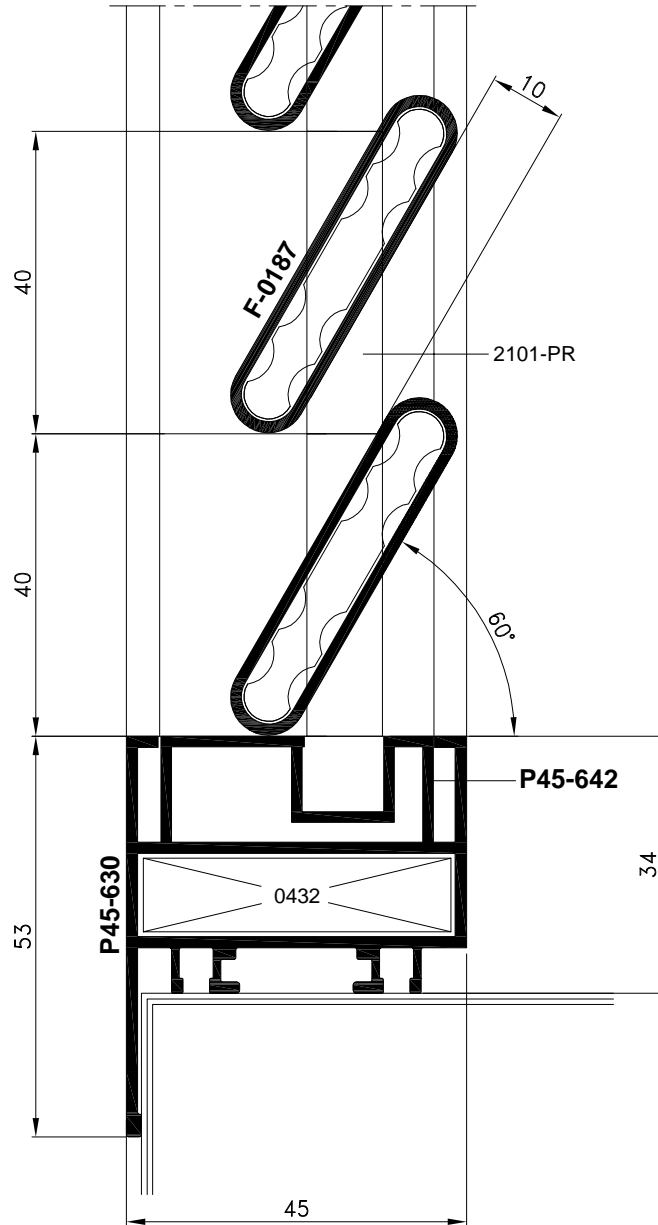

NAČIN UGRADNJE PREMA ZIDU

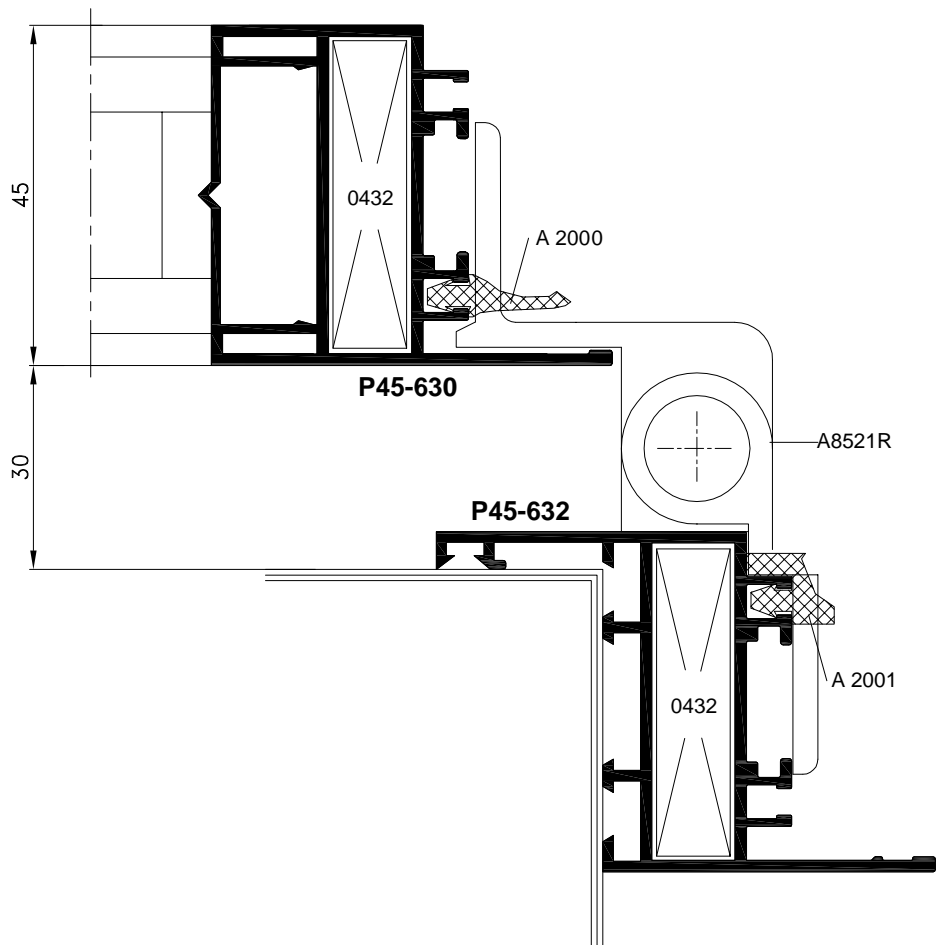
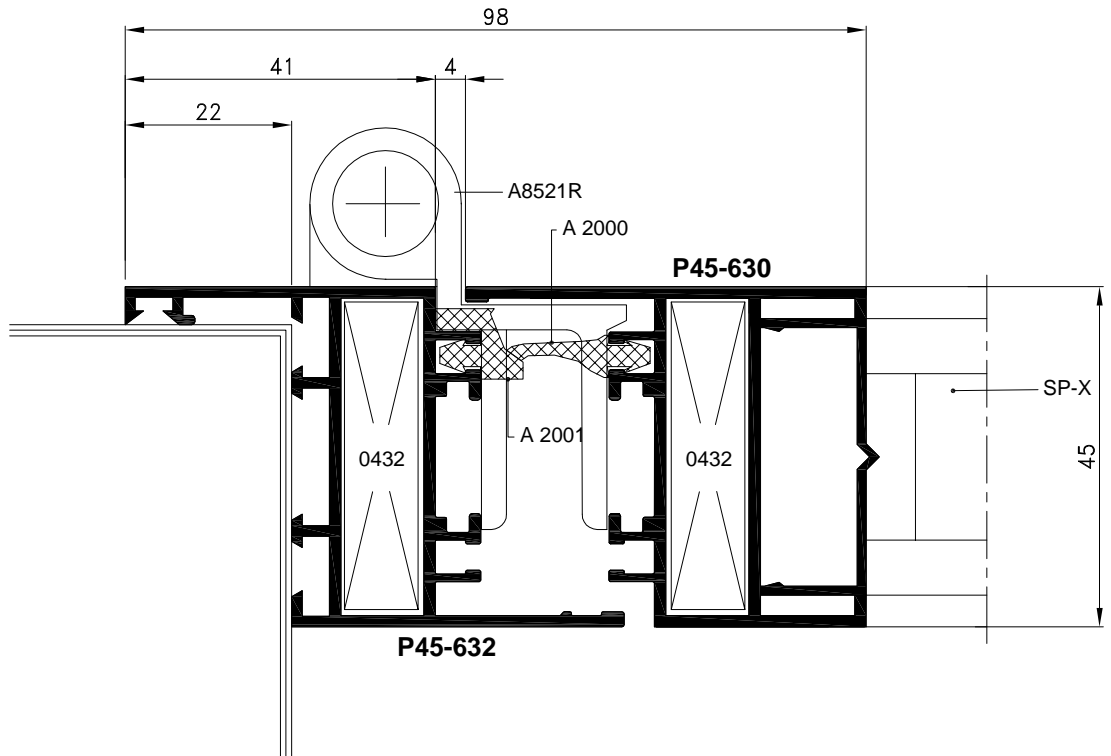

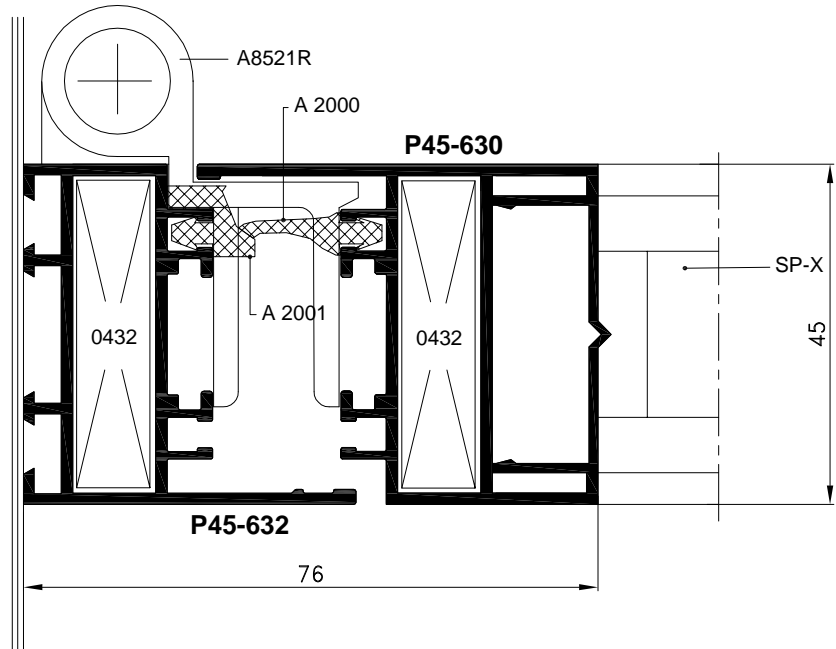

NAČIN UGRADNJE PREMA ZIDU

