

Oznaka profila	Dimenzije / b x d / mm	Teoretska težina kg/m	Napomena mm
F 1077	10x10	0.27	
F 004/A	18x3	0.145	
F 0004	20x2	0.108	
F 0295	20x3	0.162	
F 0160	20x5	0.270	r =0.2
F 0223	20x6	0.324	
F 0157	20x10	0.540	r =0.2
F 0828	20x15	0.81	
F 0127	25x2.5	0.168	
F 0222	25x4	0.270	
F 0942	25x10	0.674	r =0.25
F 0561	26x10	0.702	
F 0162	30x3	0.242	r =0.2
F 0225	30x4	0.324	
F 0161	30x5	0.405	r =0.2
F 0469	30x6	0.485	r =0.6
F 0517	30x8	0.648	
F 0370	32x16	1.382	
F 0739	32x20	1.727	r =0.5
F 0005	33x3	0.267	r =1.5
F-0161/A	35x5	0,473	
F 1207	37x22	2.198	
F 0190	40x4	0.432	
F 0487	40x8	0.864	
F 1017	40x10	1.08	
F 0288	44x8	0.950	
F 0559	50x2.5	0.337	
F 0938	50x5	0.67	
F 0954	50x6	0.81	
F 0943	50x8	1.08	r=0.25
F1075	50x10	1.35	
F 0124	50x20	2.70	
F 0491	50x30	4.050	
F 1106	60x2	0.324	
F 1074	60x4	0.648	
F 0224	60x10	1.620	
F 0488	70x3	0.567	
F 1076	80x15	3.24	
F 0159	80x10	2.160	r =0.2
061 046	80x4	0.864	
F 0368	83.5x26	5.860	r =1.0
F 1024	85x5	1.147	

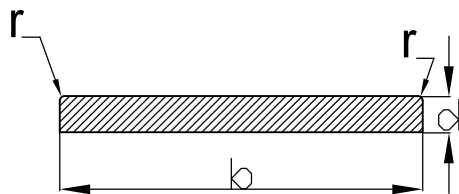

Oznaka profila	Dimenzi / b x d / mm	Teoretska težina kg/m	Napomena Mm
F 1023	90x5	1.215	
F 0391	90x8	1.944	
F 0704	95x5	1.283	
F 1022	100x5	1.35	
F 0158	100x10	2.70	r =0.2
F 0158/A	100x15	4.05	
F 1021	105x5	1.417	
F 1078	110x5	1.485	
F 1020	120x5	1.62	
F 1073	140x5	1.89	
F 1019	220x5	2.97	
F 0226	120x8	2.592	
F 0221	120x10	3.240	
F 1019	220x5	2.97	
F 1000	250x3	2.03	
F 1001	250x10	6.75	
F-1224	270x8	5.832	

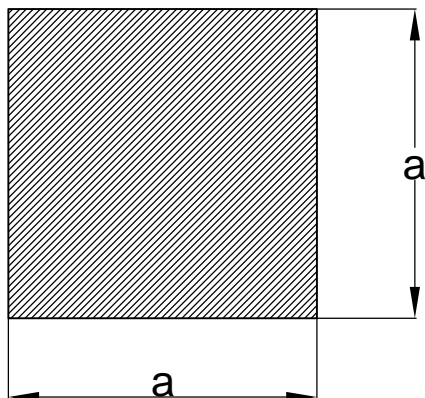

Oznaka profila	Dimenzija / a / mm	Teoretska težina kg/m	Napomena mm
F 0389	40	4.320	
F 0342	45	5.467	
F 0390	60	9.720	
F 0344	63.5	10.887	

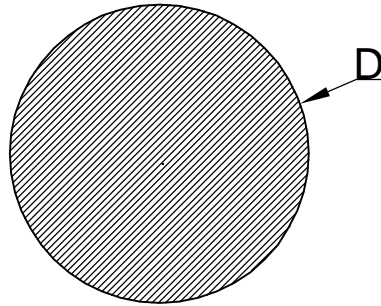

Oznaka profila	Dimenzija / D / mm	Teoretska težina kg/m	Napomena mm
F 0021	6	0.076	
F 0022	8	0.135	
F 0099	9.7	0.200	
F 0023	10	0.212	
F 0024	12	0.305	
F 0348	15	0.477	
F 0405	20	0.848	
F 0349	24	1.221	
F 0343	25	1.325	
F 0346	32	2.171	
F 0347	40	3.393	
F 0350	50	5.300	
F 0404	60	7.634	

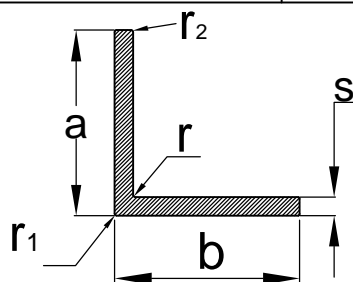

Oznaka profila	Dimenzija / a x b x s/ mm	Teoretska težina kg/m	Napomena mm
F 0047	10x10x1.8	0.088	r=r ₂ =0.3
F 0507	10x10x2	0.098	
F 0045	15x10x1.5	0.094	r=r ₂ =1.5
F 0006	15x15x1.5	0.115	
F 0008	15x15x2	0.151	
F 0168	15x15x2	0.151	r ₁ =r ₂ =0.2
F 1086	20x15x2	0.178	
F 0164	20x20x1.5	0.156	r ₁ =r ₂ =0.2
F 0009	20x20x1.5	0.156	
F 0254	20x10x1.8	0.137	
F 0010	20x20x2	0.205	
F 0165	20x20x2	0.205	r ₁ =r ₂ =0.2
F 1047	20x20x3	0.299	
F 0341	25x15x2	0.205	
F 0282	25.4x15.9x3.2	0.329	
F 0011	25x25x2	0.260	
F 0012	25x25x3	0.381	
F 0219	25x25x3	0.381	r=r ₂ =0.2
F 0500	30x10x3	0.300	
F 0171	30x15x2	0.232	r=r ₂ =0.2
F 0013	30x20x2	0.260	
F 0167	30x30x2	0.313	r ₁ =r ₂ =0.2
F 0046	30x30x3	0.456	r=3
F 0169	40x20x2	0.313	
F 0015	40x20x3	0.462	
F 0016	40x20x4	0.605	
F 0955	40x20x5	0.743	
F 0210	40x40x2	0.421	
F 0447	40x40x3	0.624	
F 0448	40x40x4	0.821	
F 0925	40x50x2	0.475	
F 0163	50x20x2	0.367	r=r ₂ =0.2
F 1046	50x20x3	0.542	
F 0490	50x25x2	0.394	
F 1048	50x30x2	0.421	
F 1045	50x30x3	0.623	
F 1085	50x45x5	1.215	
F 0166	50x50x2	0.529	
F 0924	50x50x3	0.786	
F 0449	50x50x5	1.283	
F 0975	50x50x8	1.987	
F 0400	55x38x12x15	2.835	
F 0340	60x15x2	0.394	

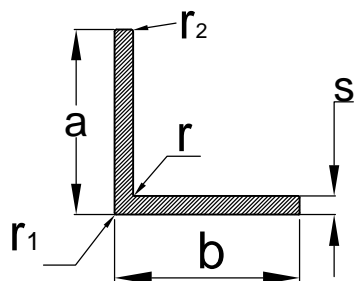

Oznaka profila	Dimenzija / a x b x s/ mm	Teoretska težina kg/m	Napomena mm
F 0170	60x20x2	0.421	r=0.2
F 0501	60x30x3	0.705	
F 0463	60x40x5	1.283	
F 0974	60x40x6	1.523	
F 0973	60x60x4	1.253	
F 0915	60x60x2	0.63	
F 0963	60x60x5	1.553	
F 0502	70x40x2	0.583	
F 0098	70x70x8.15	2.862	r ₁ =2; r ₂ =4
F 0508	75x50x5	1.620	
F 1099	80x40x8	2.42	
F 0916	80x80x3	1.27	
F 0506	100x40x5	1.822	
F 0506/A	100x45x5	1.890	
F 1044	100x50x5	1.55	
F 0498	100x64x8	3.369	
F 1043	100x100x5	2.63	
F 1042	120x50x5	2.22	
F 0956	120x80x3	1.596	
F 0499	125x80x8	4.25	

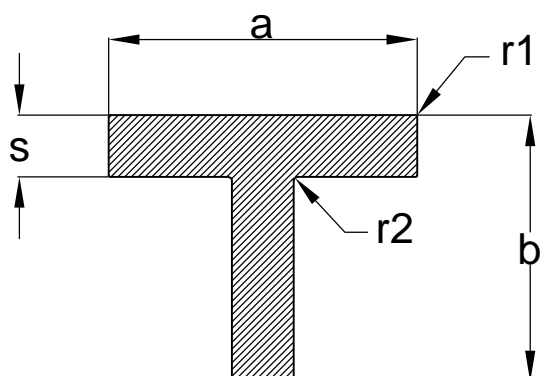

Oznaka profila	Dimenzija $a \times b \times s$ mm	Teoretska težina kg/m	Napomena mm
F 0017	20x20x2	0.205	
F 0078	25x25x2	0.26	$r1=1; r2=2$
F 0479	20x30x1.7	0.222	$r1=0.5$
F 0253	20x40x1.8	0.283	
F 0209	30x30x2	0.313	
F 0196	40x40x2	0.421	
F 0927	40x100x2	0.745	
F 0926	40x120x2	0.85	
F 0509	50x50x3	0.786	
F-1234	50x60x3	0.867	
F-1169	144x130x5	3.63	$r1=1; r2=2$

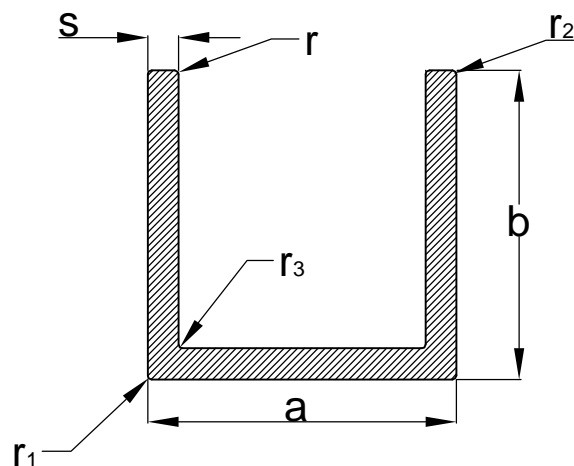

Oznaka profila	Dimenzija / b x a x b x s/ mm	Teoretska težina kg/m	Napomena mm
F 0354	6.5x13.5x6.5x1.5	0.096	$r_1 = r_3 = 0.25$
F 0137/A	15x11x15x1.5	0.153	$r_1 = r_2 = r_3 = 0.3; r = 0.75$
F 0137	15x11x15x2	0.127	$r = r_2 = r_3 = 0.2; r_1 = 1$
F 0018	15x15x15x2	0.221	$r_1 = 0.5$
F 0019	20x20x20x2	0.300	$r_1 = 0.5$
F 0220	20x20x20x2	0.310	
F 0503	20x30x20x2	0.356	
F 0474	20x30x20x3	0.518	
F 0477	20x40x20x3	0.51	
F 0939	20x40x20x3	0.6	
F 0020	20x50x20x2.5	0.573	$r_1 = 0.5$
F 0208	20x55x20x2	0.491	
F 0412	20x60x20x1.5	0.393	
F 0387	20x100x20x1.5	0.554	
F 0284	25.4x38.1x25.4x3.18	0.710	
F 0043	25x59x25x2	0.564	$r = 1.5$
F 0944	30x30x30x2	0.464	$r_1 = 0.25$
F 0172	30x45x30x2	0.518	$r_1 = 0.2$
F 0510	30x50x30x4	1.100	
F 0207	30x60x30x2	0.626	
F 0444	30x75x30x4	1.382	$r_3 = 0.4$
F 0083	40x20x40x2	0.518	$r_1 = r_3 = 0.5$
F 0957	40x20x40x2.5	0.641	
F 0141	40x30x40x3	0.761	$r_3 = 0.2$
F 0476	40x40x40x4	1.210	
F 0787	40x50x40x2	0.680	
F 0173	40x55x40x1.5	0.534	$r_1 = 0.2$
F 0439	50x76x50x1.5	0.699	
F 1056	50x50x50x4	1.534	
F 1055	50x50x50x5	1.89	
F 1054	50x80x50x5	2.295	
F 1060	50x90x50x3	1.49	
F 1053	50x100x50x5	2.565	

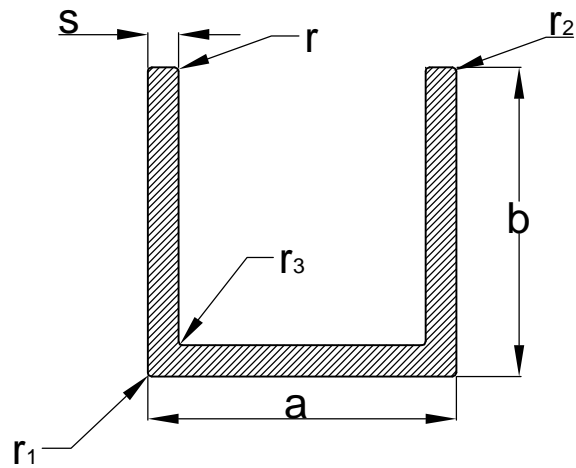

Oznaka profila	Dimenzija / b x a x b x s/ mm	Teoretska težina kg/m	Napomena mm
F 1052	50x150x50x5	3.24	
F 0044	55x59x55x2	0.889	r=1.5
F 0958	60x60x60x3	1.41	
F 0398	65x120x65x9.5	5.925	r ₃ =1
F 0585	65x140x65x8	5.490	
F 1058	80x80x80x3	1.895	
F 1057	80x100x80x3	2.057	
F 1051	120x150x120x5	5.13	

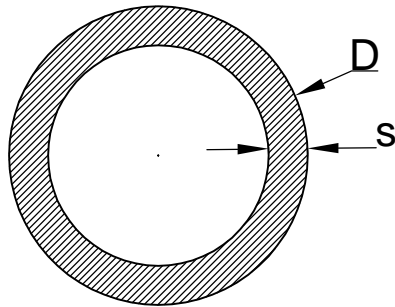

Oznaka profila	Dimenzija / D x s / mm	Teoretska težina kg/m	Napomena mm
F 0205	20x1.5	0.235	
F 0218	20x2	0.305	
F 0093	22x1.2	0.220	
F 0328	22x2	0.34	
F 0486	25x2.5	0.480	
065544	27x3	0.610	
F 0571	28x2	0.441	
F 0961	30x2	0.4725	
F 1111	30x3	0.687	
F 0504	32x1.5	0.388	
F 0094	32x3	0.737	
F 0204/A	35x1.5	0.430	
F 0204	35x2	0.560	
F 0329	38x2	0.610	
F 0351	38x3	0.890	
F 0922	40x2	0.64	
F 0446	45x3	1.068	
F 0914	50x2	0.8	
F-1230	54.5x2	0.891	
F 0352	56x3	1.349	
F 0923	60x2	0.984	
F 1063	60x17.5	6.985	
F 0600	69.9x3.8	2.130	
F 0960	70x4	2.239	
F 0703	72x4	2.307	
F 0811	75x4	2.410	
F 0512	100x3	2,467	

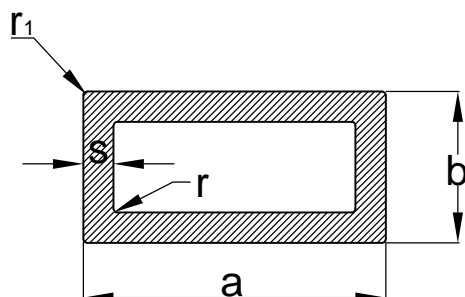

Oznaka profila	Dimenzija / a x b x s / mm	Teoretska težina kg/m	Napomena mm
F 0183	20x10x1.5	0.218	r ₁ =r ₂ =0.2
F 0959	30x10x2	0.39	
F 0182	30x15x1.5	0.340	r ₁ =r ₂ =0.2
F 0197	30x20x2	0.496	
F 0505	30x20x2.5	0.607	
F 0514	35x20x2.5	0.675	
F 1196	40x20x1.6	0,485	r ₁ =1.7; r=0.5
F 0181	40x20x2	0.605	
F 0031	40x20x2	0.605	r=r ₁ =0.5
F 0032	40x30x2.5	0.877	r=r ₁ =0.5
F 0481	40x30x3	1.036	
F-1184	42x27x1.2	0.384	r=9.2
F 0049	45x28x2	0.745	
F 0493	50x20x1.5	0.543	
F 0198	50x20x2	0.713	
F 1039	50x20x3	1.03	
F 0489	50x25x2	0.766	
F-0489/A	50x25x4	1.447	
F 0033	50x30x2	0.821	r=r ₁ =0.5
F 0034	50x30x2.5	1.011	r=r ₁ =0.5
F 0485	50x40x2	0.930	
F 0485/A	50x40x2.5	1.147	
F 1033	50x60x4	2.2	
F 0201	60x30x2	0.929	
F 1034	60x30x4	1.77	
F 0180	60x40x2	1.037	r=r ₁ =0.2
F 0381	60x40x4	1.987	r=r ₁ =5
F 0320	70x25x2	0.937	r=4 ; r ₁ =6
F 0941	80x20x1.5	0.786	r ₁ =0.2
F 0441	80x30x2	1.150	r ₁ =0.2
F 0441/A	80x30x3	1.685	
F 0176	80x40x2	1.253	r ₁ =0.2
F 0688	80x50x1.8	1.229	r ₁ =0.3
F 0380	90x60x4	3.067	r=r ₁ =5
F 0202	100x20x1.8	1.131	
F 0492	100x25x1.5	1.032	r=1.5 ; r ₁ =3
F 0300	100x25x1.75	1.148	

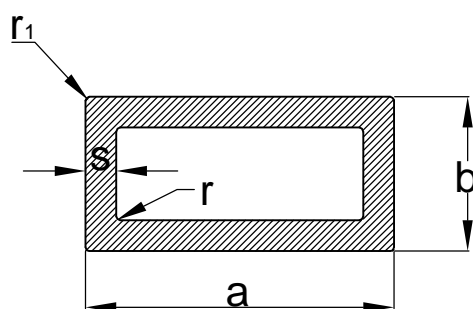

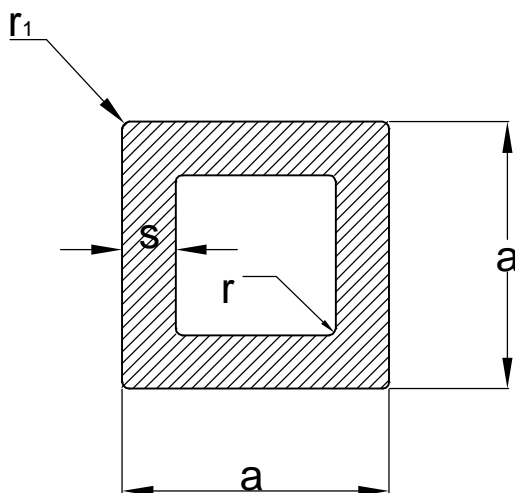

Oznaka profila	Dimenzija / a x b x s / mm	Teoretska težina kg/m	Napomena mm
F 0177	100x30x2	1.361	r ₁ =0.2
F 0203	100x50x2	1.577	
F 1037	100x50x3	2.33	
F 1032	100x50x4	3.06	
F 1030	100x50x5	3.78	
F 1035	150x100x3	3.95	

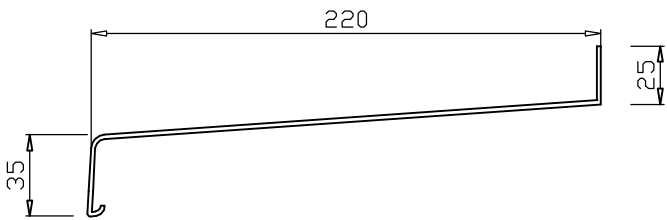
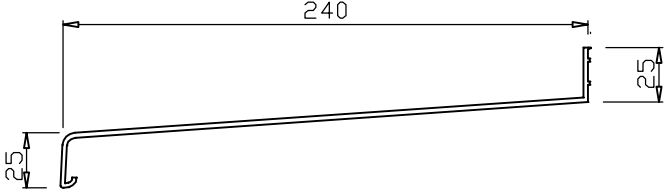
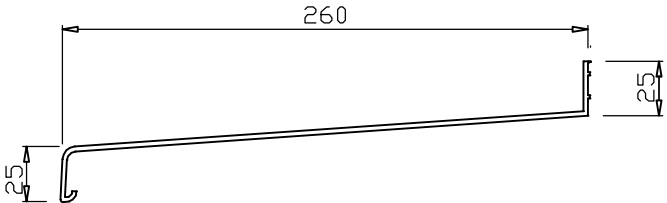

Oznaka profila	Dimenzija / a x s / mm	Teoretska težina kg/m	Napomena mm
F 0025	10x1	0.097	r=0.5
F 0026	15x1.5	0.218	r=0.5
F 0027	20x2	0.389	r=0.5
F 0028	25x1.5	0.381	r=0.5
F 0029	25x2	0.497	r=0.5
F 1002	30x1.2	0.373	
F 0030	30x2	0.605	r=0.5
F 0178	30x2	0.605	
F 0921	30x3	0.87	
F 0174	40x2	0.820	
F 0962	40x2.5	0.966	r1=5,r=2.5
F 0911	40x3	1.2	
F 0778	40x4	1.550	
F 0048/A	45x1.6	0.75	
F 0048	45x1.8	0.840	
F 0179	45x2	0.929	r=0.2
F 0175	50x2	1.037	
F 0912	50x3	1.52	
F 0913	60x2	1.25	
F 0937	60x3	1.84	
F 0945	60x4	2.42	r=2.5
F 0511	65x2.5	1.688	
F 1083	80x4	3.28	
F 1084	80x2.5	2.093	
F 1036	100x3	3.14	
F 1031	100x4	4.14	
F 1079	100x5	5.13	
F 1080	120x5	6.21	

Oznaka	Izgled-presjek	Težina kg/m'	Opseg mm
F-0144		0.380	188.35
F-0680		0.717	358.00
F-0680/A		0.798	398.00
F-0680/B		0.658	328.00
F-0680/C		1.128	467.00
F-0680/E		1.356	506.00
F-0680/F		1.464	546.00

Oznaka	Izgled-presjek	Težina kg/m'	Opseg mm
F-0680/G		1.370	567.4
F-0680/H		1,721	591
F-0680/I		1,84	631
F-0680/J		1,959	671

Oznaka	Izgled-presjek	Težina /kg/m'/	Opseg /mm/
F-0057		0,307	148
F-0058		0,324	158,5
F-0085		0,389	179
F-0494		0,255	1,39
F-0496		0,321	160
F-0515		0,288	134
F-0516		0,383	184
F-0587		0,360	181

Oznaka	Izgled-presjek	Težina /kg/m'/	pseg /mm/
F-0604		0.487	242
F-0613		0.520	265
F-0613/A		0.476	266
F-0615		0.535	307
F-0664		0.573	306
F-0670		0.467	253
F-0671		0.452	245
F-0693		0.520	261

Oznaka	Izgled-presjek	Težina /kg/m'/	Opseg /mm/
F-0737		0,477	276
F-0806		0,55	300,98
F-0838		0,112	70,23
F-0865		0,502	276
F-0879		0,090	70,571
F-0880		0,465	271,488
F-0881		0,365	194
F-0890		0,347	227

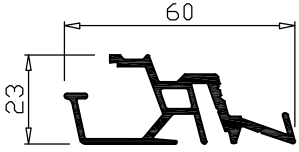
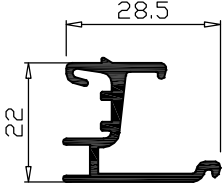
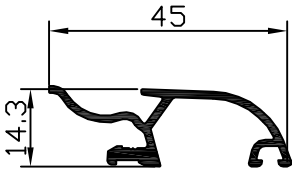
Oznaka	Izgled-presjek	Težina /kg/m'/	Opseg /mm/
F-0602		0.68	272
F-0979		0.366	172
F-1071		0.332	172,92

Oznaka	Izgled-presjek	Težina (kg/m)	Opseg (mm)
F 0140		2.080	180.87
F 0142		0,800	257,00
F 0147		0.850	295.84
F 0148		1.040	379.9
F 0149		0,79	160,00
F 0150		0.320	93.40
F 0273		1,850	298,00
F 0303		0.700	266,60
F 0304		0,960	263,00

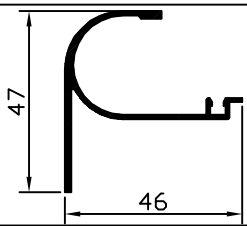
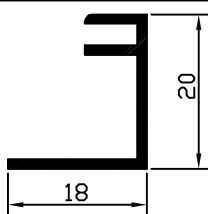
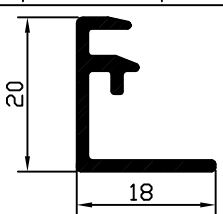
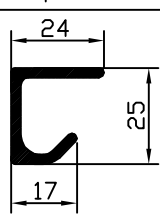
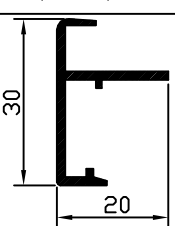
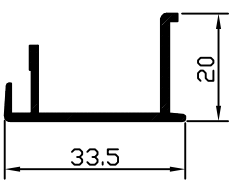
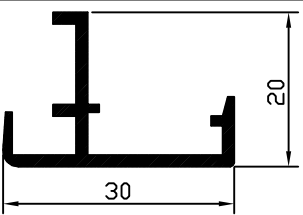
Oznaka	Izgled-presjek	Težina (kg/m)	Opseg (mm)
F 0128		0.390	230.00
F 0129		0.165	109.00
F 0130		0.209	101.49
F 0131		0.457	125.00
F 0371		0.245	129.89
F 0375		0.271	144.30
F 0518		0.269	142.00

Oznaka	Izgled-presjek	Težina (kg/m)	Opseg (mm)
F 0001		0.40	160
F 0002		0.310	125
F 0003		0.205	88
F 0007		0.250	89.53
F 0014		0.973	344.14
F 0036		0.144	57.00
F 0037		0.226	88
F 0038		0.38	132.50
F 0039		0.42	168

Oznaka	Izgled-presjek	Težina (kg/m)	Opseg (mm)
F 0040		0.608	151.430
F 0041		0.229	83.400
F 0042		0.910	360.00
F 0054		0.516	216.80
F 0055		0.294	131.936
F 0056		0.978	406.800
F 0062		1.450	260.000
F 0065		0.256	96.800
F 0066		0.663	126.870

Oznaka	Izgled-presjek	Težina (kg/m)	Opseg (mm)
F 0070		0.155	79.40
F 0072		0.550	152
F 0075		0.625	279
F 0076		0.819	359.22
F 0077		0.207	76.56
F 0078		0.260	96.56
F 0079		0.275	106.10
F 0080		0.227	170.14
F 0081		0.267	200.14

Oznaka	Izgled-presjek	Težina (kg/m)	Opseg (mm)
F 0082		0.458	197.67
F 0084		0.283	131.40
F 0089/A		0.532	303
F 0090		0.40	141.20
F 0091		0.45	168
F 0092		0.602	202
F 0095		0.668	143.13
F 0096		0.635	210.9
F 0102		4.6	356

Oznaka	Izgled-presjek	Težina (kg/m)	Opseg (mm)
F 0104		0.935	324.062
F 0105		0.990	260.00
F 0106		0.380	124.00
F 0107		0.740	180
F 0108		1.000	417.00
F 0109/1		0.418	55.025
F 0110		1.256	195
F 0111		1.138	176.79
F 0112		0.503	97.4

Oznaka	Izgled-presjek	Težina (kg/m)	Opseg (mm)
F 0113		0.15	72.00
F 0114		0.38	142.00
F 0120		0.247	125.510
F 0123		0.335	147.00
F 0125		0.193	123.140
F 0126		0.399	150.110
F 0130		0.155	106.456
F 0134		0.345	193.770
F 0135		0.240	60.00

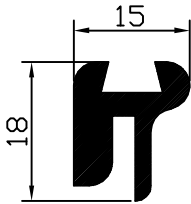
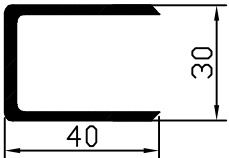
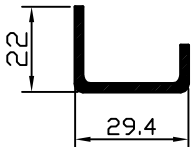
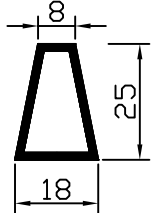
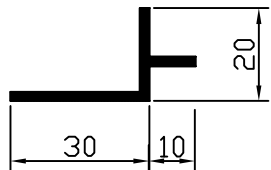
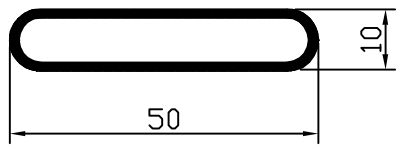
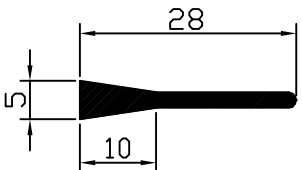
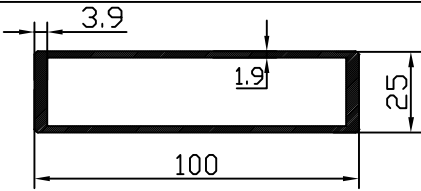
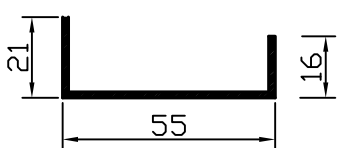
Oznaka	Izgled-presjek	Težina (kg/m)	Opseg (mm)
F 0136		0.345	373.00
F 0141		0.690	207.870
F 0150		0.320	93.40
F 0184		0.287	76.990
F 0186		0.313	120.00
F 0187		0.397	111.00
F 0191		0.190	62.36
F 0195		1.470	248.280
F 0206		0.360	181.00

Oznaka	Izgled-presjek	Težina (kg/m)	Opseg (mm)
F-0211		0.605	344
F 0238		1.08	148.000
F 0239		1.300	246.170
F 0240		0.496	173.410
F 0241		0.554	137.945
F 0242		1.940	456.900
F 0243		1.72	506.64
F 0245		1.250	278
F 0246		1.280	386.00

Oznaka	Izgled-presjek	Težina (kg/m)	Opseg (mm)
F 0247		0.527	131.42
F 0248		1.875	400.5
F 0249		1.860	389.8
F 0250		1.754	338.37
F 0252		0.66	168
F 0255		0.139	55.50
F 0261		2.06	435.41
F 0262		0.25	90.55
F 0263		2.32	265.72

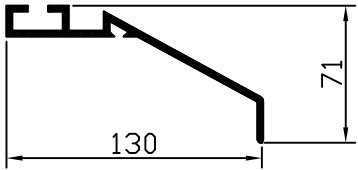
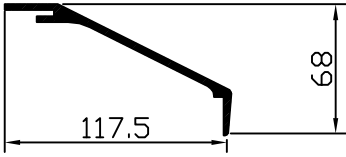
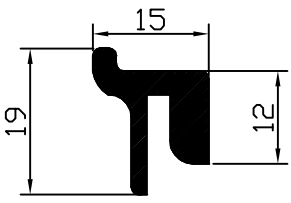
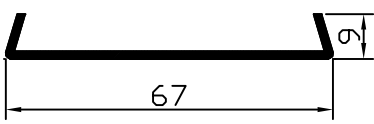
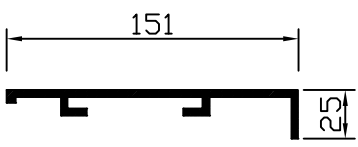
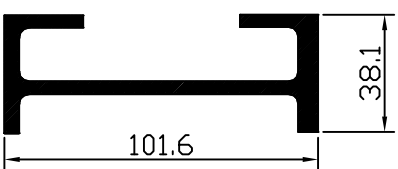
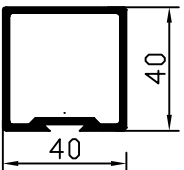
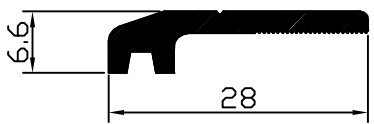
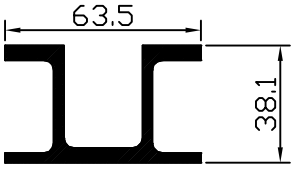
Oznaka	Izgled-presjek	Težina (kg/m)	Opseg (mm)
F 0265		1.770	443.460
F 0266		1.500	295.950
F 0267		0.330	80.000
F 0269		0.330	165.91
F 0270		2.035	436.00
F 0275		2.300	418.560
F 0276		0.870	168.170
F 0277		0.217	75.142
F 0281		1.700	324.690

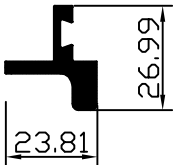
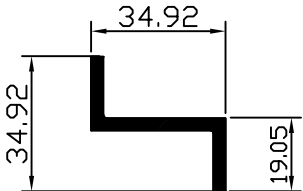
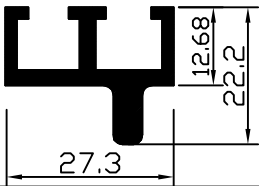
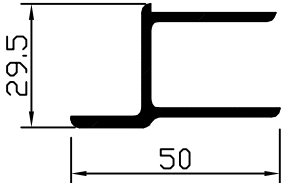
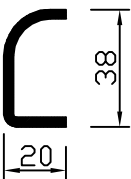
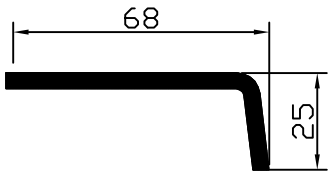
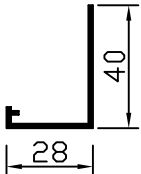
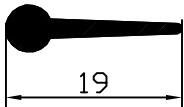
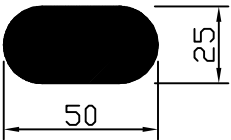
Oznaka	Izgled-presjek	Težina (kg/m)	Opseg (mm)
F 0285		0.496	106.870
F 0286		0.521	139
F 0287		0.518	192.10
F 0290		0.600	212
F 0291		0.580	116
F 0292		0.910	178.2
F 0293		0.306	149
F 0294		0.108	42.7
F 0296		3.035	572

Oznaka	Izgled-presjek	Težina (kg/m)	Opseg (mm)
F 0326		1.107	187.000
F 0327		0.650	237.00
F 0352/A		1.450	175.930
F 0356		1.052	200.000
F 0357		0.793	231.600
F 0358		0.917	231.600
F 0359		1.200	457.700
F 0360		0.183	49.700
F 0361		0.177	53.400



Oznaka	Izgled-presjek	Težina (kg/m)	Opseg (mm)
F 0362		2.340	365.9
F 0363		1.750	260.9
F 0364		1.741	307.300
F 0365		2.230	457.300
F 0371		0.245	129.890
F 0372		0.642	147.000
F 0373		0.864	261.1
F 0374		1.500	292.13
F 0375		0.270	144.310

Oznaka	Izgled-presjek	Težina (kg/m)	Opseg (mm)
F 0378		0.450	142.27
F 0379		0.629	270
F 0385		1.294	245.8
F 0386		0.290	82.000
F 0388		0.640	315
F 0393		3.000	521.4
F 0394		0.270	113.500
F 0396		0.450	111.4
F 0402		4.000	453

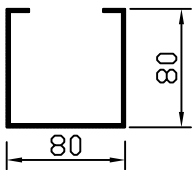
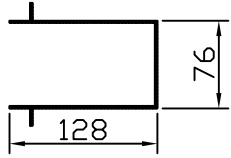
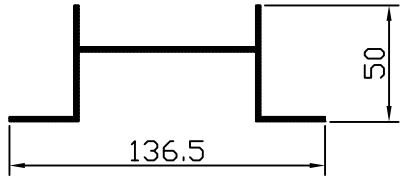
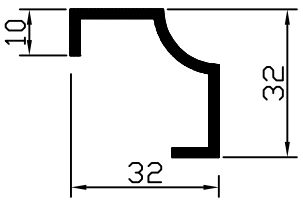
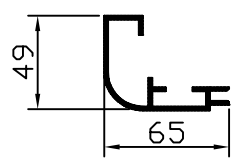
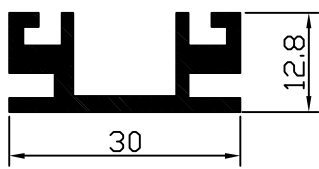
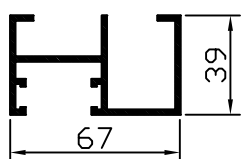
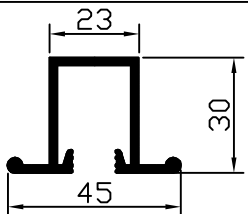
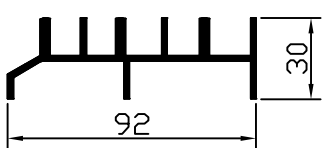
Oznaka	Izgled-presjek	Težina (kg/m)	Opseg (mm)
F 0403		0.925	212.9
F 0407		1.400	398.15
F 0408		0.626	198.5
F 0413		0.476	234
F 0414		0.185	106
F 0415		0.338	174.2
F 0417		0.780	234.9
F 0433		0.375	138
F 0435		0.223	69.9

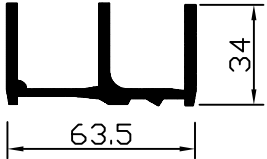
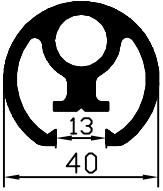
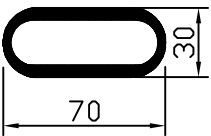
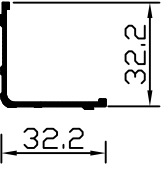
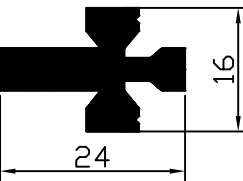
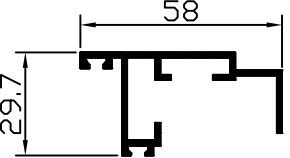
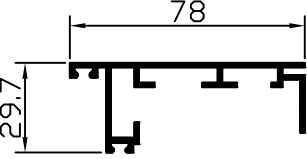
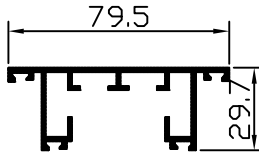
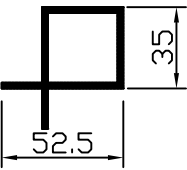
Oznaka	Izgled-presjek	Težina (kg/m)	Opseg (mm)
F 0437		1.550	526.800
F 0438		1.930	718.000
F 0440		1.260	469.000
F 0442		0.391	149.100
F 0443		0.958	361.000
F 0459		0.442	157.400
F 0464		1.140	428.000
F 0465		0.650	239.200
F 0466		1.300	428.100

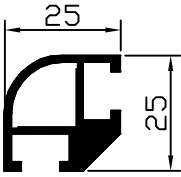
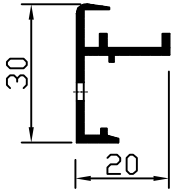
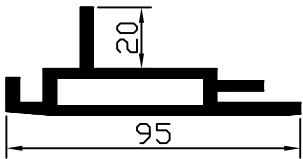
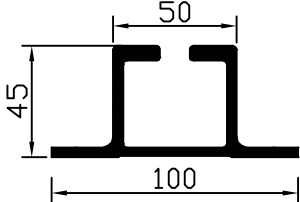
Oznaka	Izgled-presjek	Težina (kg/m)	Opseg (mm)
F 0467		1.400	313.500
F 0468		1.800	250.600
F 0471		1.900	174.200
F 0478		0.210	133.500
F 0480		0.490	94.500
F 0482		0.617	302.800
F 0483		0.795	390.3
F 0484		0.933	449.5
F 0497		1.110	210.000

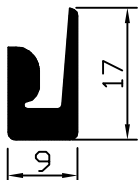
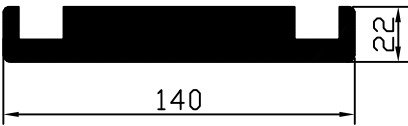
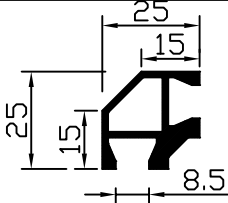
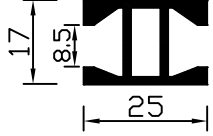
Oznaka	Izgled-presjek	Težina (kg/m)	Opseg (mm)
F 0513		0.540	137.900
F 0518		0.265	141.700
F 0519		1.917	304.300
F 0521		2.400	423.00
F 0525		0.670	253.200
F 0527		0.223	67.100
F 0529		7.040	370.800
F 0536		0.550	133.00
F 0537		0.450	130.00

Oznaka	Izgled-presjek	Težina (kg/m)	Opseg (mm)
F 0539		1.740	324.000
F 0540		1.430	274.000
F 0541		0.190	75.000
F 0543		0.399	163.700
F 0544		0.609	81.700
F 0555		0.197	70.000
F 0556		1.080	402
F 0560		0.864	261.1
F 0566		0.36	163.9

Oznaka	Izgled-presjek	Težina (kg/m)	Opseg (mm)
F 0567		0.320	63.77
F 0568		0.500	248.5
F 0569		0.313	157
F 0570		1.026	396.7
F 0576		0.670	264.5
F 0584		0.130	86.1
F 0588		0.675	170.2
F 0598		0.714	320.60
F 0601		0.608	274.9

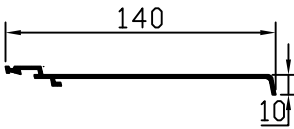
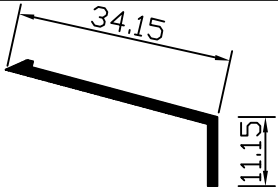
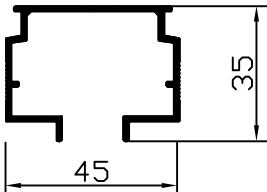
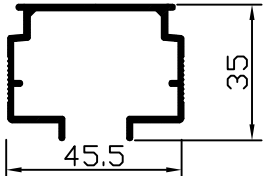
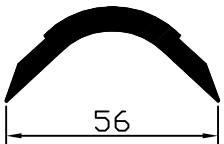
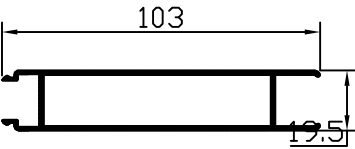
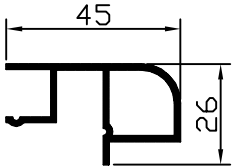
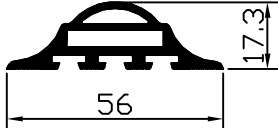
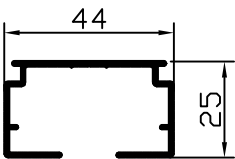
Oznaka	Izgled-presjek	Težina (kg/m)	Opseg (mm)
F 0603		0.715	329.70
F 0633/1		0.184	93.7
F 0660		0.546	289
F 0660/A		0.544	293
F 0666		0.96	149.80
F 0681		0.92	304
F 0682		0.491	191
F 0690		0.752	179
F 0692		0.45	254

Oznaka	Izgled-presjek	Težina (kg/m)	Opseg (mm)
F 0696		0.484	193
F 0709		1.075	402
F 0711		1.332	129.94
F 0714		0.895	294
F 0741		0.111	86
F 0753		0.722	361
F 0771		0.68	363
F 0779		0.115	63.6
F 0805		0.55	237.67

Oznaka	Izgled-presjek	Težina (kg/m)	Opseg (mm)
F-0211/SP		0.23	120
F Z 032		0.49	143.2
F Z 033		0.95	253.2
F Z 037		1.75	332
F Z 044		1.83	280
F 1040		4.57	180