

VENTILIRAJUĆE FASADNE OBLOGE

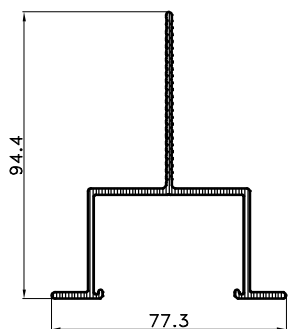

F-1120
tež.:1.160 kg/m'

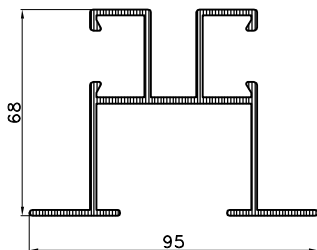

F-5-5-1
tež.:1.641 kg/m'

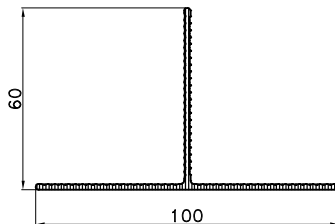

F-0934
tež.:0.78 kg/m'

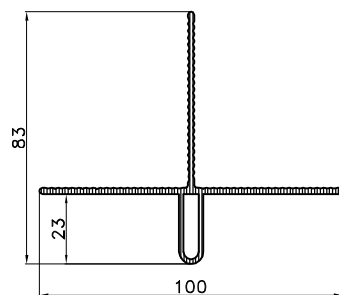

F-1119
tež.:0.978 kg/m'

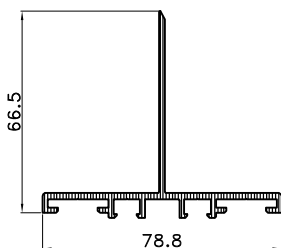

KF-001
tež.:0.964 kg/m'

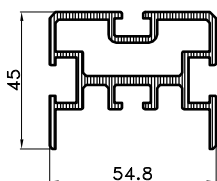

F-0798
tež.:1.55 kg/m'

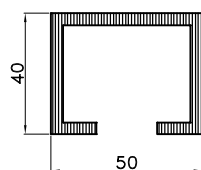

KF-022
tež.:1.55 kg/m'

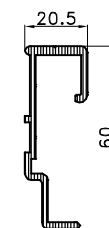

F-1098
tež.:0.655 kg/m'

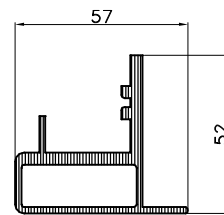

KF-020/22
tež.:1.377 kg/m'

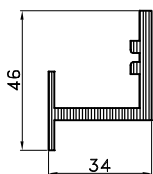

KF-020/21
tež.:0.895 kg/m'

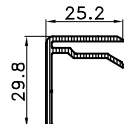

F-0895
tež.:0.33 kg/m'

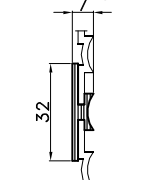

F-0007
tež.:0.253 kg/m'

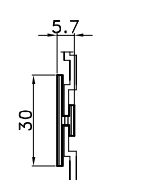

F-0041
tež.:0.224 kg/m'

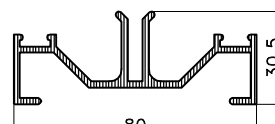

061045
tež.:1.025 kg/m'

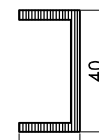

F-0939
tež.:0.60 kg/m'

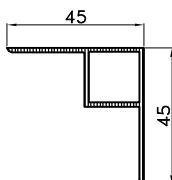

F-1124
tež.:0.477 kg/m'

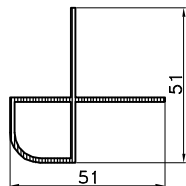

F-1125
tež.:0.545 kg/m'

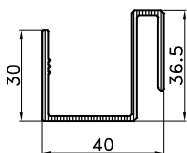

F-1130
tež.:1.60 kg/m'

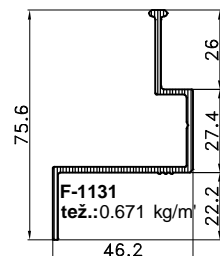

F-1131
tež.:0.671 kg/m'

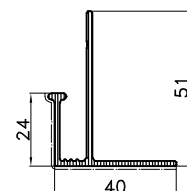

F-1132
tež.:0.567 kg/m'

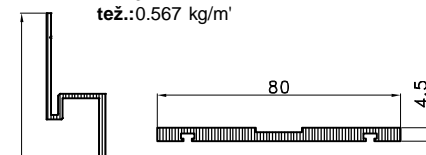

060807
tež.:0.85 kg/m'



VAL-331
tež.:0.970 kg/m'

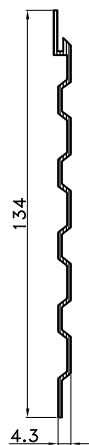

F-0211
tež.:0.553 kg/m'

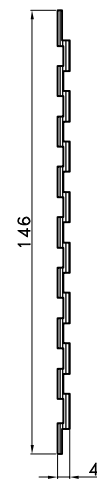

F-0042
tež.:0.910 kg/m'

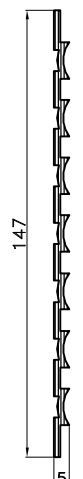

F-0014
tež.:1.00 kg/m'



F-0771
tež.:0.681 kg/m'

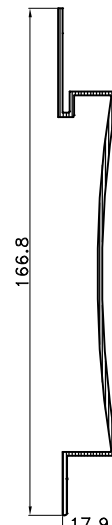

F-1133
tež.:0.878 kg/m'

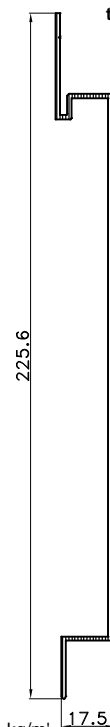

F-0917
tež.:1.41 kg/m'

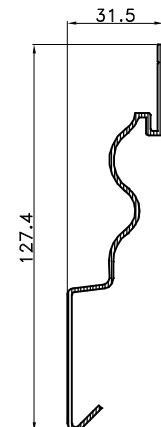

F-1126
tež.:0.704 kg/m'

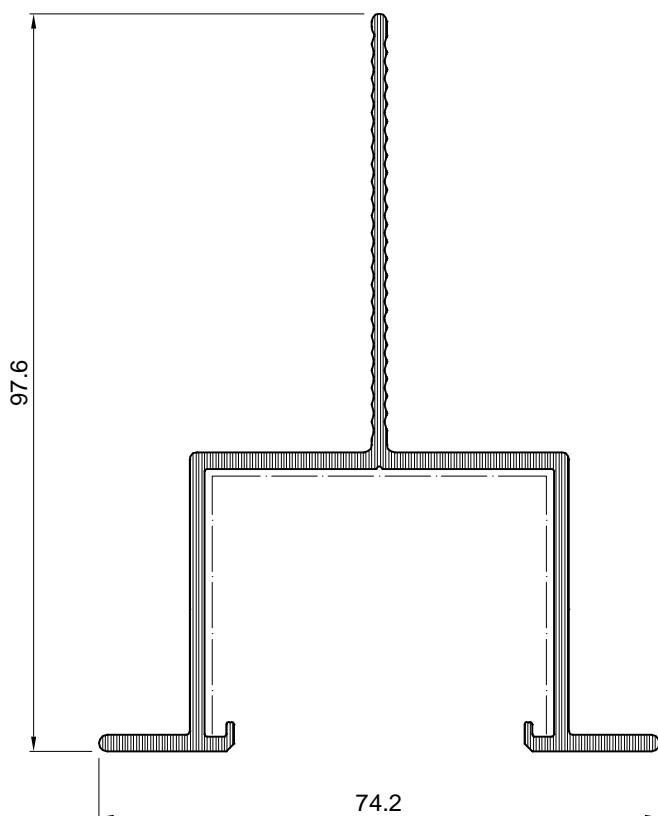

Okomica alucobonda		
Art.-Br.	F-1120	
Težina	kg/m'	1.160
Opseg	mm	439.48
Moment inercije	I _x (cm ⁴)	27.619
	I _y (cm ⁴)	16.836
	W _x (cm ³)	2.297
	W _y (cm ³)	3.112
Dužina isporuke	mm	6500

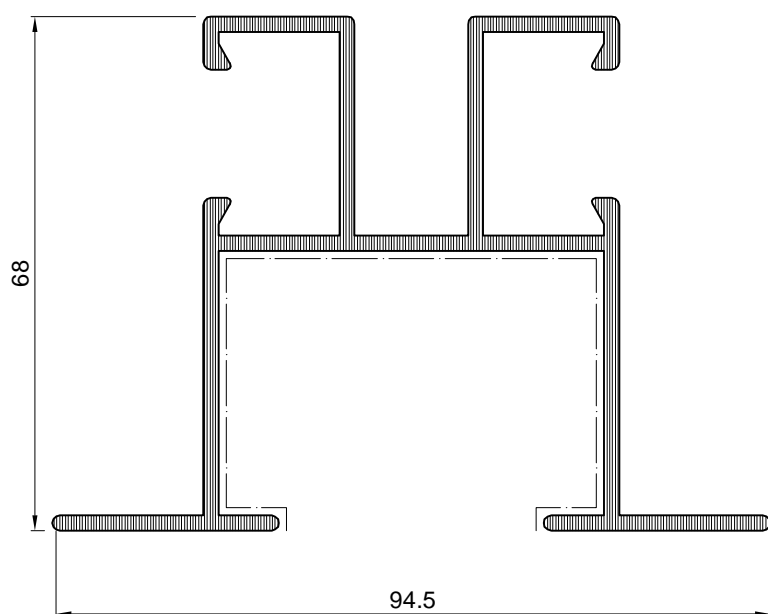

Okomica alucobonda		
Art.-Br.	F-5-5-1	
Težina	kg/m'	1.641
Opseg	mm	602.54
Moment inercije	I _x (cm ⁴)	32.806
	I _y (cm ⁴)	32.994
	W _x (cm ³)	9.609
	W _y (cm ³)	6.946
Dužina isporuke	mm	6500

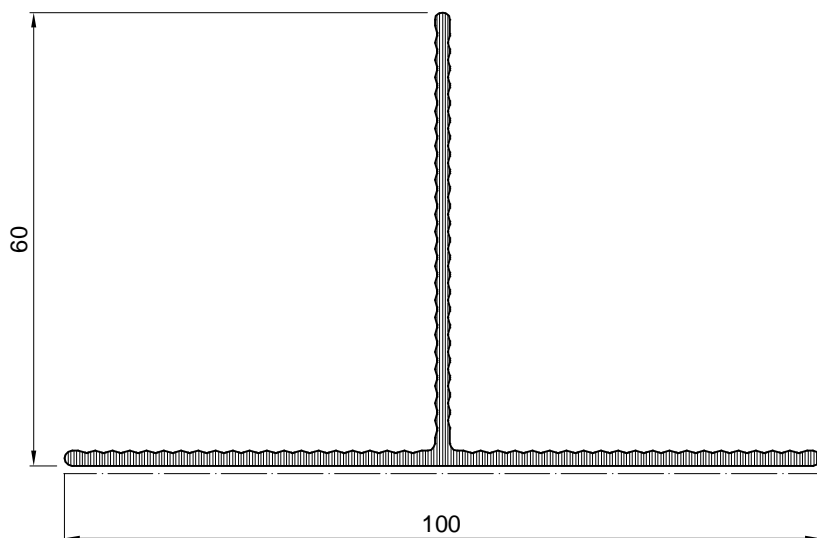

Okomica vent. fasade		
Art.-Br.	F-0934	
Težina	kg/m'	0.78
Opseg	mm	325.63
Moment inercije	I _x (cm ⁴)	8.70
	I _y (cm ⁴)	15.55
	W _x (cm ³)	1.78
	W _y (cm ³)	3.11
Dužina isporuke	mm	6500

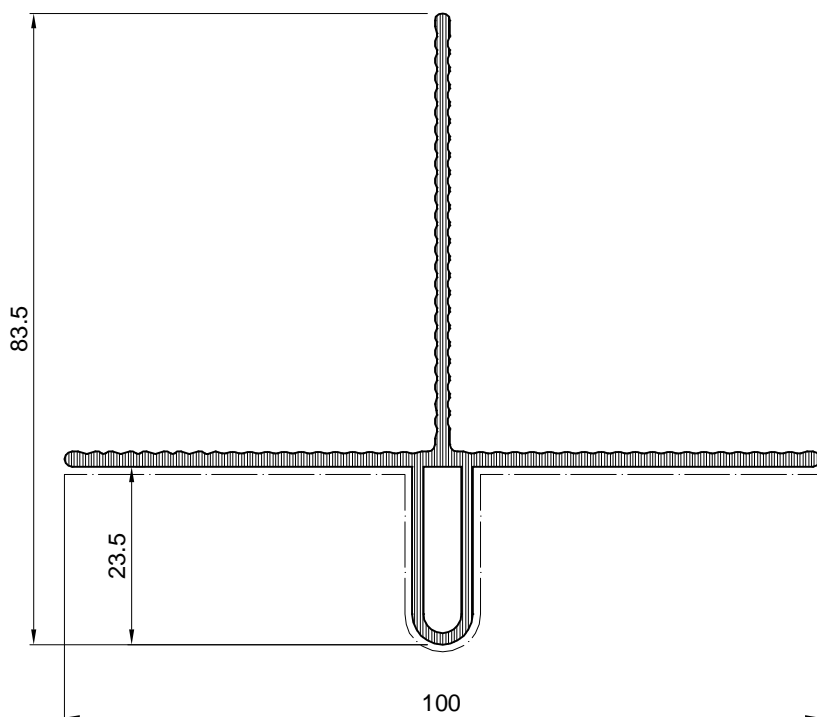

Okomica vent. fasade		
Art.-Br.	F-1119	
Težina	kg/m'	0.978
Opseg	mm	373.19
Moment inercije	I _x (cm ⁴)	12.288
	I _y (cm ⁴)	15.561
	W _x (cm ³)	2.297
	W _y (cm ³)	3.112
Dužina isporuke	mm	6500

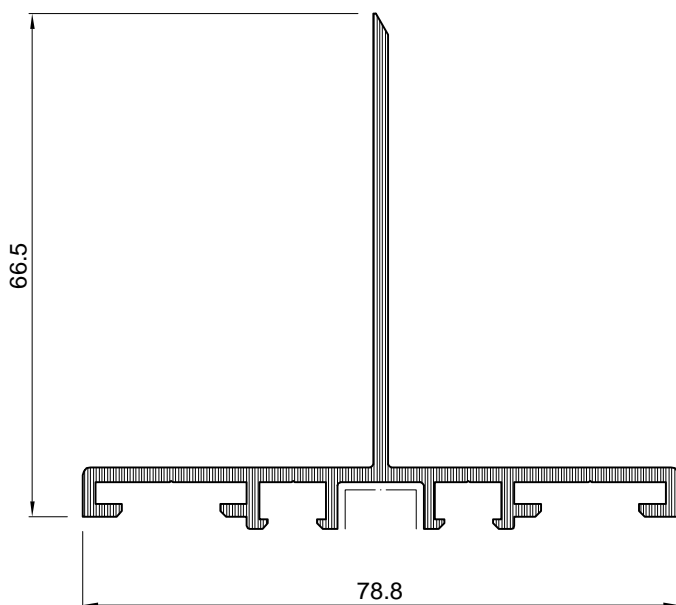

Okomica keramične fasade		
Art.-Br.	KF-001	
Težina	kg/m'	0.964
Opseg	mm	380.08
Moment inercije	I _x (cm ⁴)	11.558
	I _y (cm ⁴)	13.000
	W _x (cm ³)	2.226
	W _y (cm ³)	3.299
Dužina isporuke	mm	6500

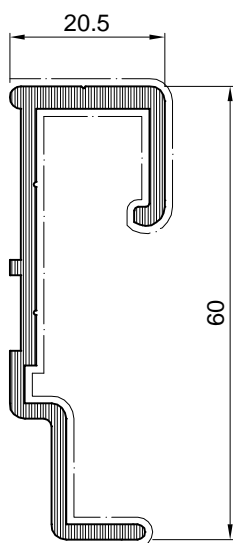

Vodoravnica za trespu		
Art.-Br.	F-1098	
Težina	kg/m'	0.655
Opseg	mm	226.88
Moment inercije	I _x (cm ⁴)	10.146
	I _y (cm ⁴)	1.050
	W _x (cm ³)	2.812
	W _y (cm ³)	0.847
Dužina isporuke	mm	6500

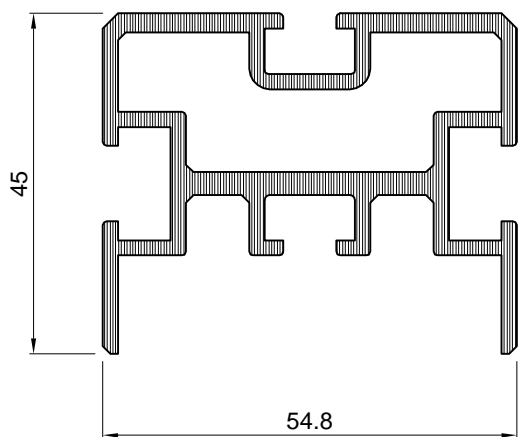

Okomica kamene fasade		
Art.-Br.	F-0798	
Težina	kg/m'	1.55
Opseg	mm	356.14
Moment inercije	I _x (cm ⁴)	8.346
	I _y (cm ⁴)	18.460
	W _x (cm ³)	3.055
	W _y (cm ³)	6.737
Dužina isporuke	mm	6500

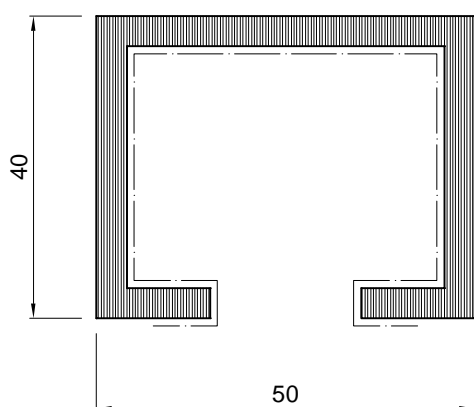

Okomica kamene fasade		
Art.-Br.	KF-022	
Težina	kg/m'	1.55
Opseg	mm	296.00
Moment inercije	I _x (cm ⁴)	12.235
	I _y (cm ⁴)	21.643
	W _x (cm ³)	5.438
	W _y (cm ³)	8.657
Dužina isporuke	mm	6500

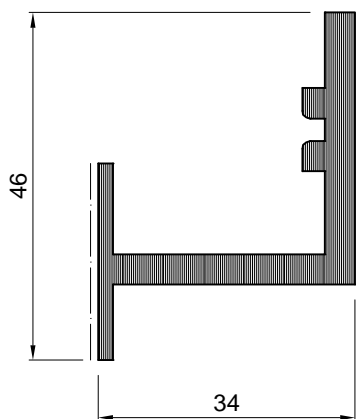

Vodoravnica keramičke fasade		
Art.-Br.	KF-020/21	
Težina	kg/m'	0.895
Opseg	mm	195.14
Dužina isporuke	mm	6500

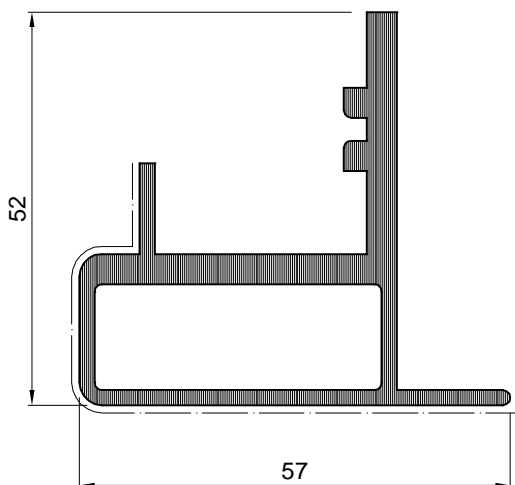

Vodoravnica keramičke fasade		
Art.-Br.	KF-020/22	
Težina	kg/m'	1.377
Opseg	mm	249.71
Dužina isporuke	mm	6500



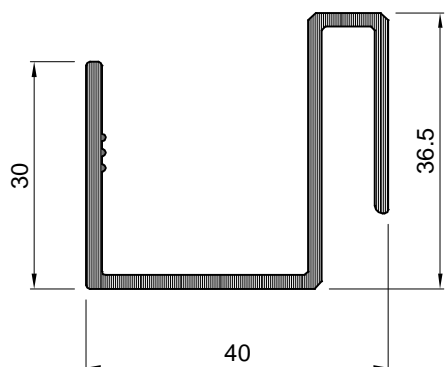

Donji horiz. držač alucobonda		
Art.-Br.	F-1130	
Težina	kg/m'	1.60
Opseg	mm	256.37
Dužina isporuke	mm	6500

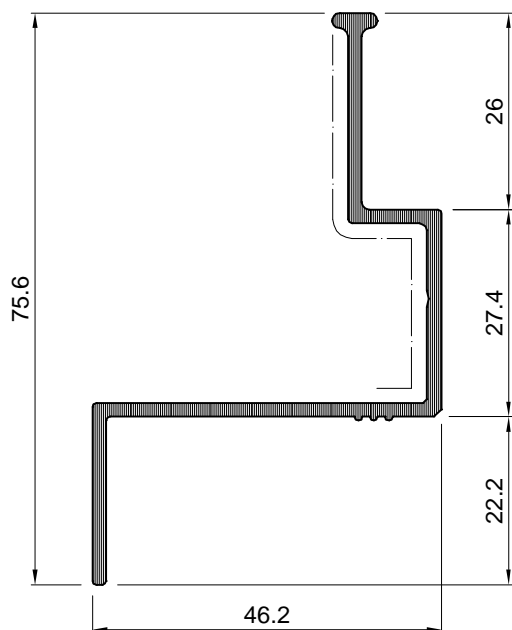

Gornji horiz. držač alucobonda		
Art.-Br.	F-1131	
Težina	kg/m'	0.671
Opseg	mm	268.91
Dužina isporuke	mm	6500

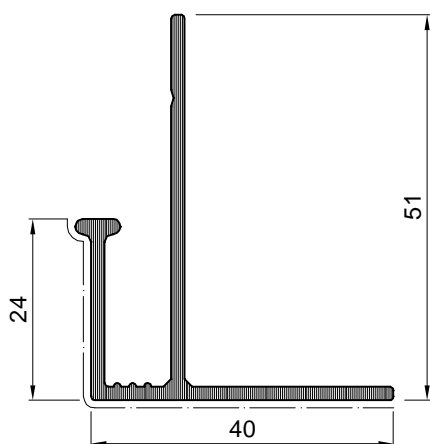

Završni držač alucobonda		
Art.-Br.	F-1132	
Težina	kg/m'	0.567
Opseg	mm	231.47
Dužina isporuke	mm	6500

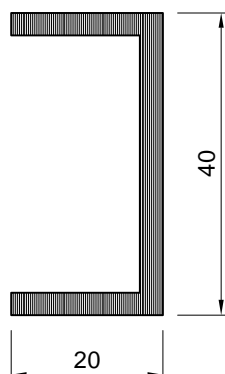

Vertikalni držač alucobonda		
Art.-Br.	F-0939	
Težina	kg/m'	0.60
Opseg	mm	154.00
Dužina isporuke	mm	6000

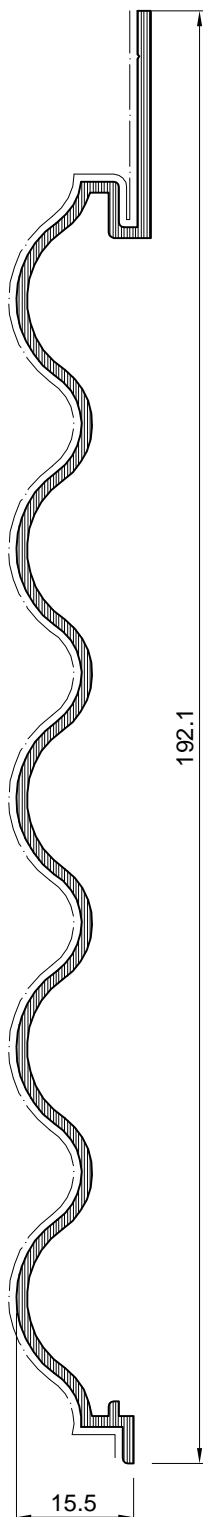

Profil fasadne obloge		
Art.-Br.	VAL-331	
Težina	kg/m'	0.970
Opseg	mm	497.83
Moment inercije	I _x (cm ⁴)	120.787
	I _y (cm ⁴)	1.061
	W _x (cm ³)	12.012
	W _y (cm ³)	1.021
Dužina isporuke	mm	6500

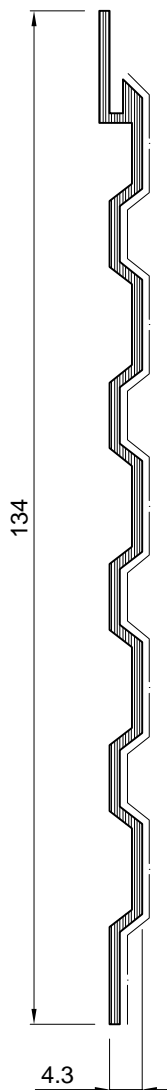

Profil fasadne obloge		
Art.-Br.	F-0211	
Težina	kg/m'	0.553
Opseg	mm	312.68
Moment inercije	I _x (cm ⁴)	31.595
	I _y (cm ⁴)	0.0508
	W _x (cm ³)	4.498
	W _y (cm ³)	0.153
Dužina isporuke	mm	sd

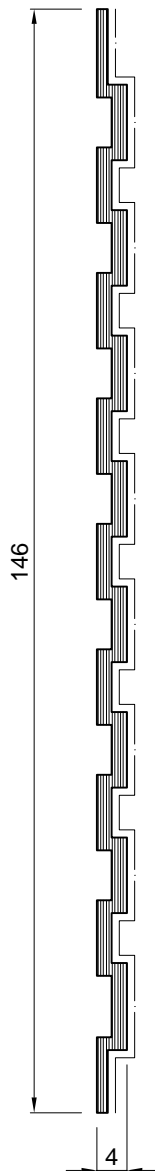

Profil fasadne obloge		
Art.-Br.	F-0042	
Težina	kg/m'	0.910
Opseg	mm	360.00
Moment inercije	I _x (cm ⁴)	55.611
	I _y (cm ⁴)	0.046
	W _x (cm ³)	7.598
	W _y (cm ³)	0.224
Dužina isporuke	mm	sd

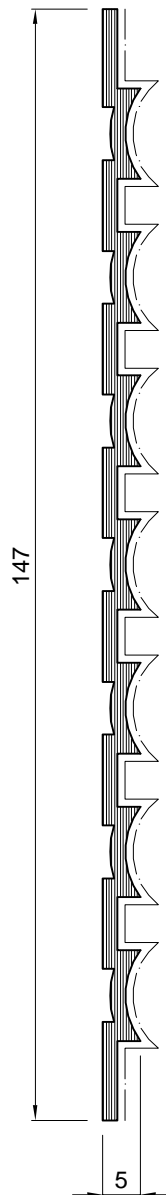

Profil fasadne obloge		
Art.-Br.	F-0014	
Težina	kg/m'	1.00
Opseg	mm	368.12
Moment inercije	I _x (cm ⁴)	64.70
	I _y (cm ⁴)	0.025
	W _x (cm ³)	8.803
	W _y (cm ³)	0.131
Dužina isporuke	mm	6500

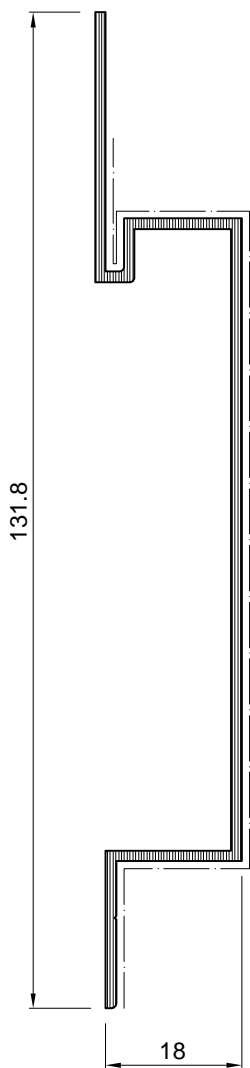

Profil fasadne obloge		
Art.-Br.	F-0771	
Težina	kg/m'	0.681
Opseg	mm	363.03
Moment inercije	I _x (cm ⁴)	37.085
	I _y (cm ⁴)	1.610
	W _x (cm ³)	5.450
	W _y (cm ³)	1.445
Dužina isporuke	mm	6500

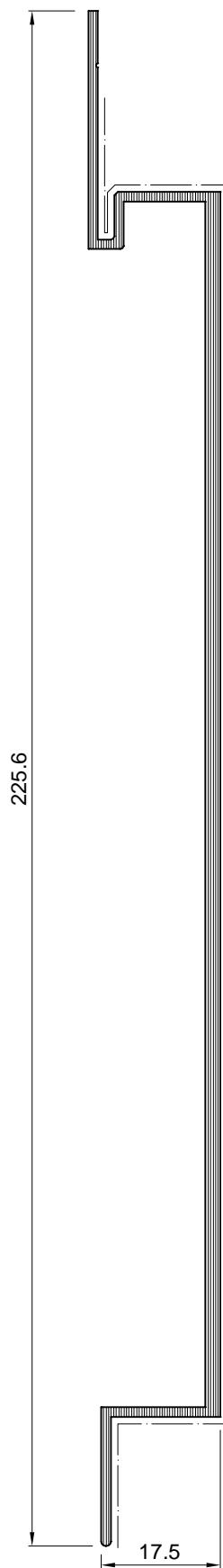

Profil fasadne obloge		
Art.-Br.	F-0917	
Težina	kg/m'	1.41
Opseg	mm	547.00
Moment inercije	I _x (cm ⁴)	221.053
	I _y (cm ⁴)	2.183
	W _x (cm ³)	19.243
	W _y (cm ³)	1.467
Dužina isporuke	mm	6500

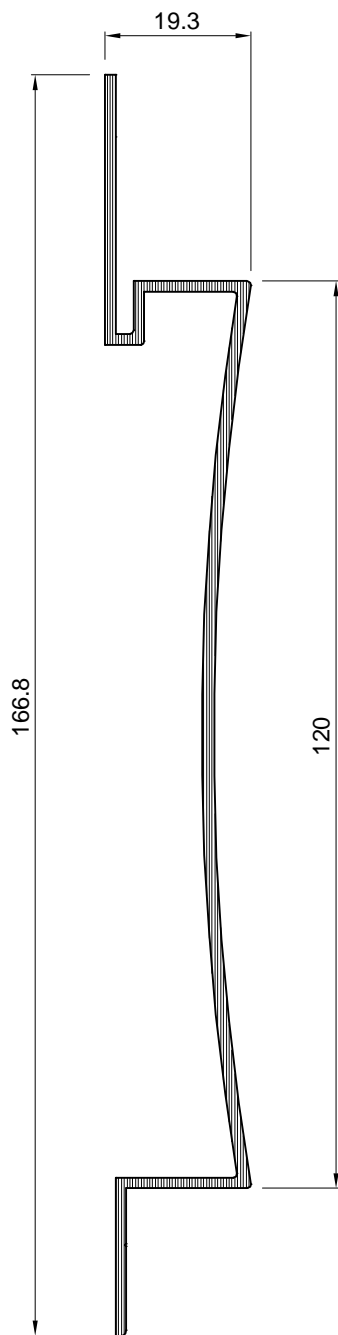

Profil fasadne obloge		
Art.-Br.	F-1133	
Težina	kg/m'	0.878
Opseg	mm	431.95
Moment inercije	I _x (cm ⁴)	78.53
	I _y (cm ⁴)	1.294
	W _x (cm ³)	9.138
	W _y (cm ³)	1.198
Dužina isporuke	mm	6500

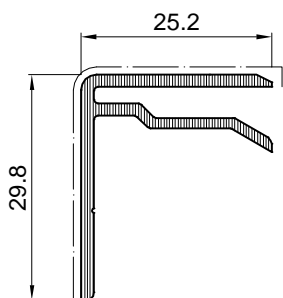

Al profil		
Art.-Br.	F-0895	
Težina	kg/m'	0.33
Opseg	mm	157.60
Dužina isporuke	mm	6500

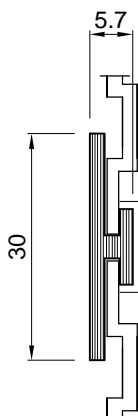

Al profil		
Art.-Br.	F-0041	
Težina	kg/m'	0.224
Opseg	mm	83.00
Dužina isporuke	mm	6500

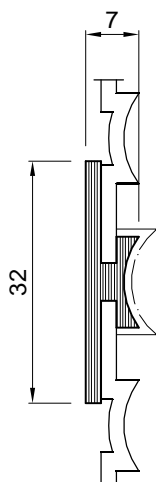

Al profil		
Art.-Br.	F-0007	
Težina	kg/m'	0.253
Opseg	mm	93.00
Dužina isporuke	mm	6500

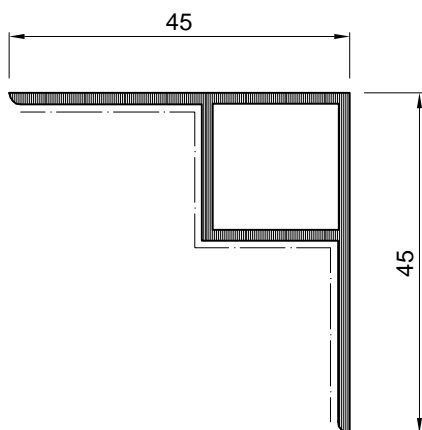

Al profil		
Art.-Br.	F-1124	
Težina	kg/m'	0.477
Opseg	mm	178.72
Dužina isporuke	mm	6500

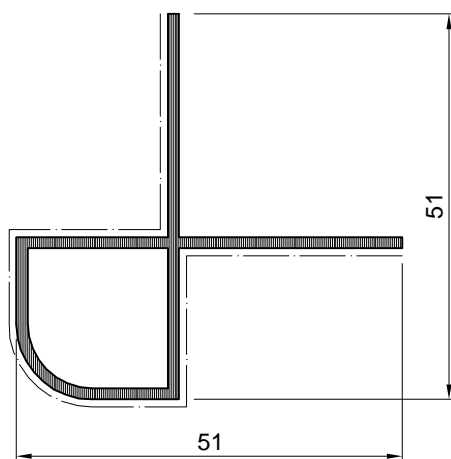

Al profil		
Art.-Br.	F-1125	
Težina	kg/m'	0.545
Opseg	mm	199.71
Dužina isporuke	mm	6500

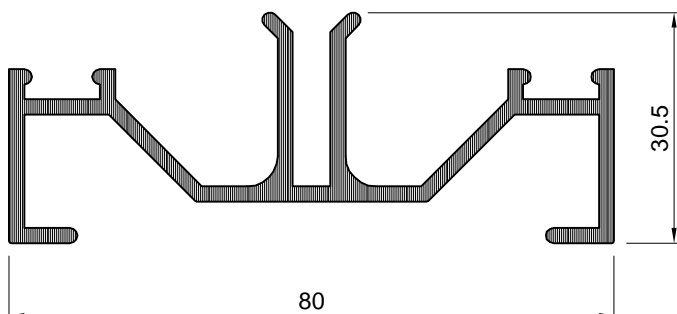

Al profil		
Art.-Br.	061045	
Težina	kg/m'	1.025
Opseg	mm	
Dužina isporuke	mm	6500

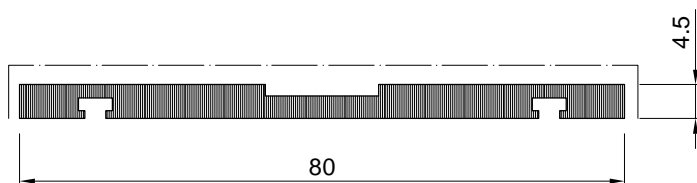

Al profil		
Art.-Br.	060807	
Težina	kg/m'	0.85
Opseg	mm	186.00
Dužina isporuke	mm	6500

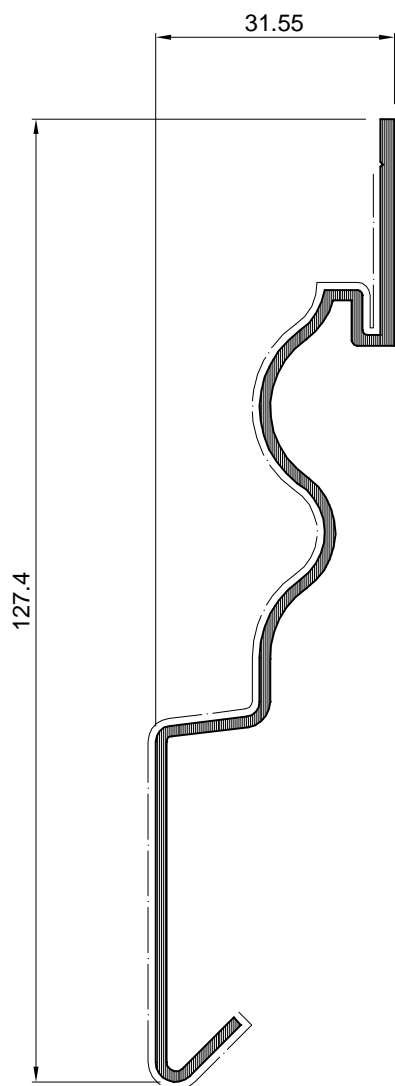

Al profil		
Art.-Br.	F-1126	
Težina	kg/m'	0.704
Opseg	mm	358.66
Dužina isporuke	mm	6500

Oznaka	Izgled	Opis
VF-014		<p>Materijal: Al Fiksni kutnik Koristi se za termoizolaciju max.70 mm</p>
VF-015		<p>Materijal: Al Pokretni kutnik Koristi se za termoizolaciju max.70 mm</p>
VF-016		<p>Materijal: Al Fiksni kutnik Koristi se za termoizolaciju max.115 mm</p>
VF-017		<p>Materijal: Al Pokretni kutnik Koristi se za termoizolaciju max.115 mm</p>
VF-013/60		<p>Materijal: Al Kutnik ventilirane fasade</p>

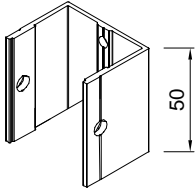
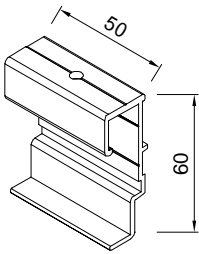
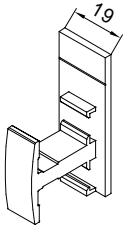
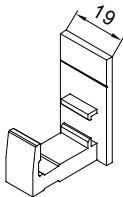
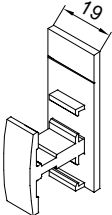
Oznaka	Izgled	Opis
KS-A50		<p>Materijal: Al Držač alucobonda</p>
KS-T50		<p>Materijal: Al Nosач trespe</p>
KS-19		<p>Materijal: Al Srednja kopča keramičke fasade Koristi se za keramiku 8-12 mm</p>
KDG-19		<p>Materijal: Al Gornja i donja kopča keramičke fasade Koristi se za keramiku 8-12 mm</p>
KS-19/A		<p>Materijal: Al Srednja kopča keramičke fasade Koristi se za keramiku 12-16 mm</p>

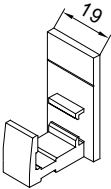
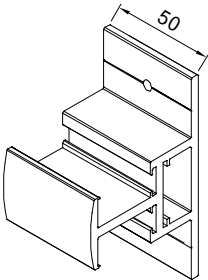
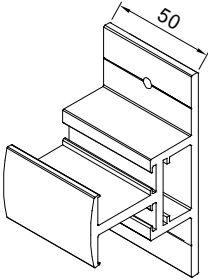
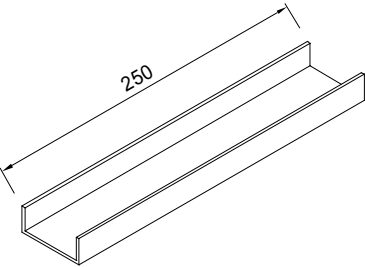
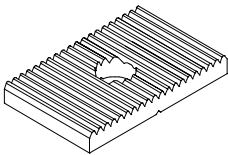
Oznaka	Izgled	Opis
KDG-19/A		<p>Materijal: Al Gornja i donja kopča keramičke fasade Koristi se za keramiku 12-16 mm</p>
KKF-50		<p>Materijal: Al Kopča kamene fasade Koristi se za kamen 20-25 mm</p>
KKF-50-S		<p>Materijal: Al Kopča kamene fasade Koristi se za kamen 30 mm</p>
SP-250-F		<p>Materijal: Al Spojnica okomice F-5-5-1</p>
F-0896-25		<p>Materijal: Al Podloška nosača</p>

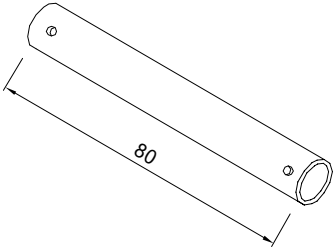
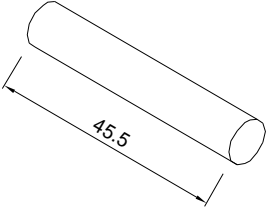

Oznaka	Izgled	Opis
inox osovina Ø7x80		<p>Materijal: inox Nosач alucobonda sa spojnicom Ø2.5</p>
inox osovina Ø7x45.5		<p>Materijal: inox Nosач alucobonda</p>

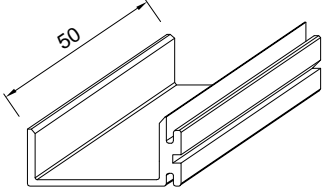
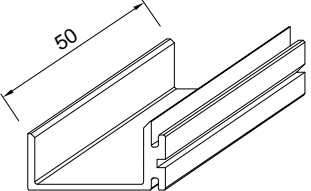
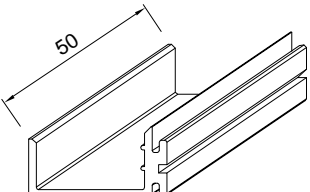
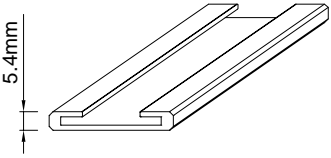
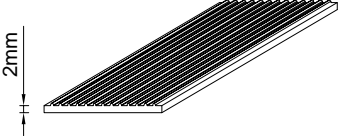

Oznaka	Izgled	Opis

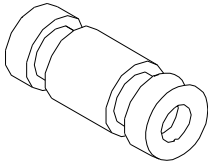
Oznaka	Izgled	Opis
PK-131-30		<p>Materijal: Tvrdi pvc (crni) Umetak za kamen d=30 mm</p>
PK-131-25		<p>Materijal: Tvrdi pvc (crni) Umetak za kamen d=25 mm</p>
PK-131-20		<p>Materijal: Tvrdi pvc (crni) Umetak za kamen d=20 mm</p>
C-VK-01		<p>Materijal: Tvrdi pvc (crni) Obloga nosača kamene fasade l=4 m</p>
Art 1370		<p>Materijal: Tvrdi pvc (crni) Podmetač kamena, keramike i trespe</p>

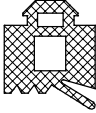
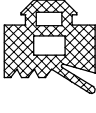
Oznaka	Izgled	Opis
PI-AU-101		<p>Materijal: Tvrđi pvc (crni) Distancer između inox osovinnice i alucobonda</p>

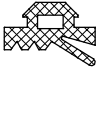
Oznaka	Izgled	Opis
02877		<p>Materijal: EPDM Brtva prema keramici (staklu) Unutarnja nosi 9 mm</p>
1966		<p>Materijal: EPDM Brtva prema keramici (staklu) Unutarnja nosi 7 mm</p>
02864		<p>Materijal: EPDM Brtva prema keramici (staklu) Unutarnja nosi 5 mm</p>
02852		<p>Materijal: EPDM Brtva prema keramici (staklu) Unutarnja nosi 3 mm</p>



Oznaka	Izgled	Opis

VENTILIRAJUĆE
FASADNE OBLOGE

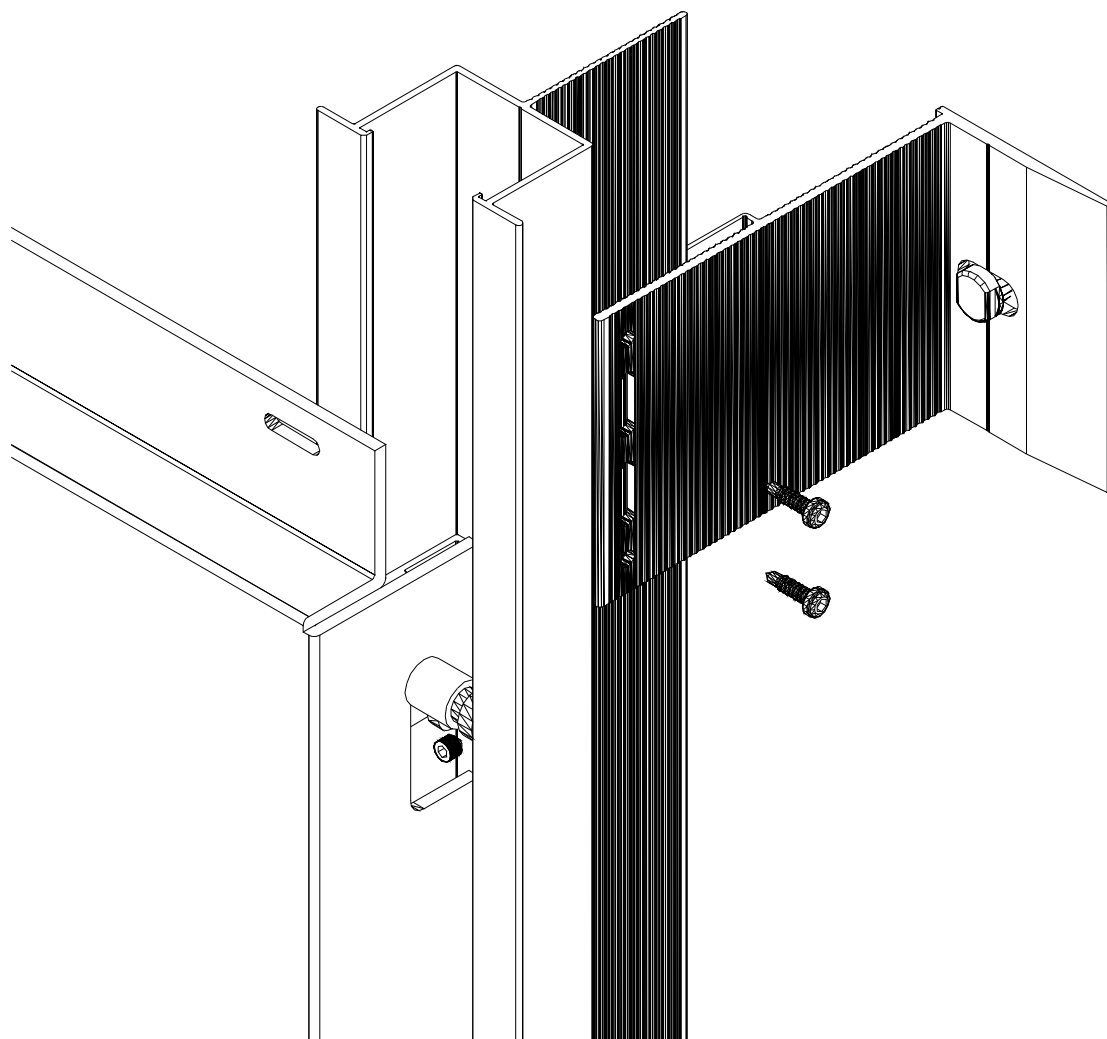

ALUCOBOND FASADA

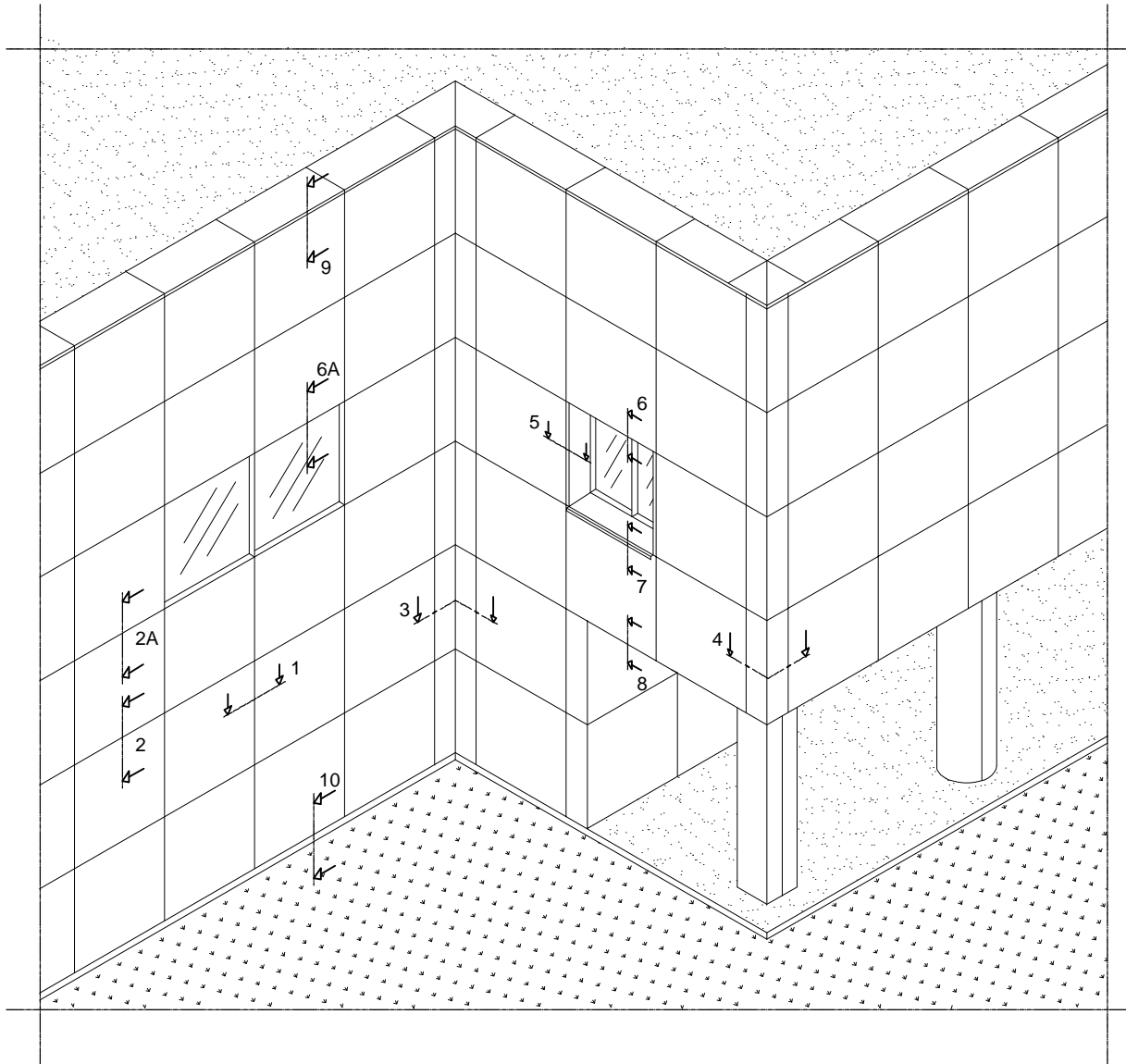

- ① kutnik VF-014/VF-015 fiksni /pokretni/
L=90 mm
- ② kutnik VF-016/VF-017 fiksni /pokretni/
L=130 mm
- ③ profil okomice F-1120

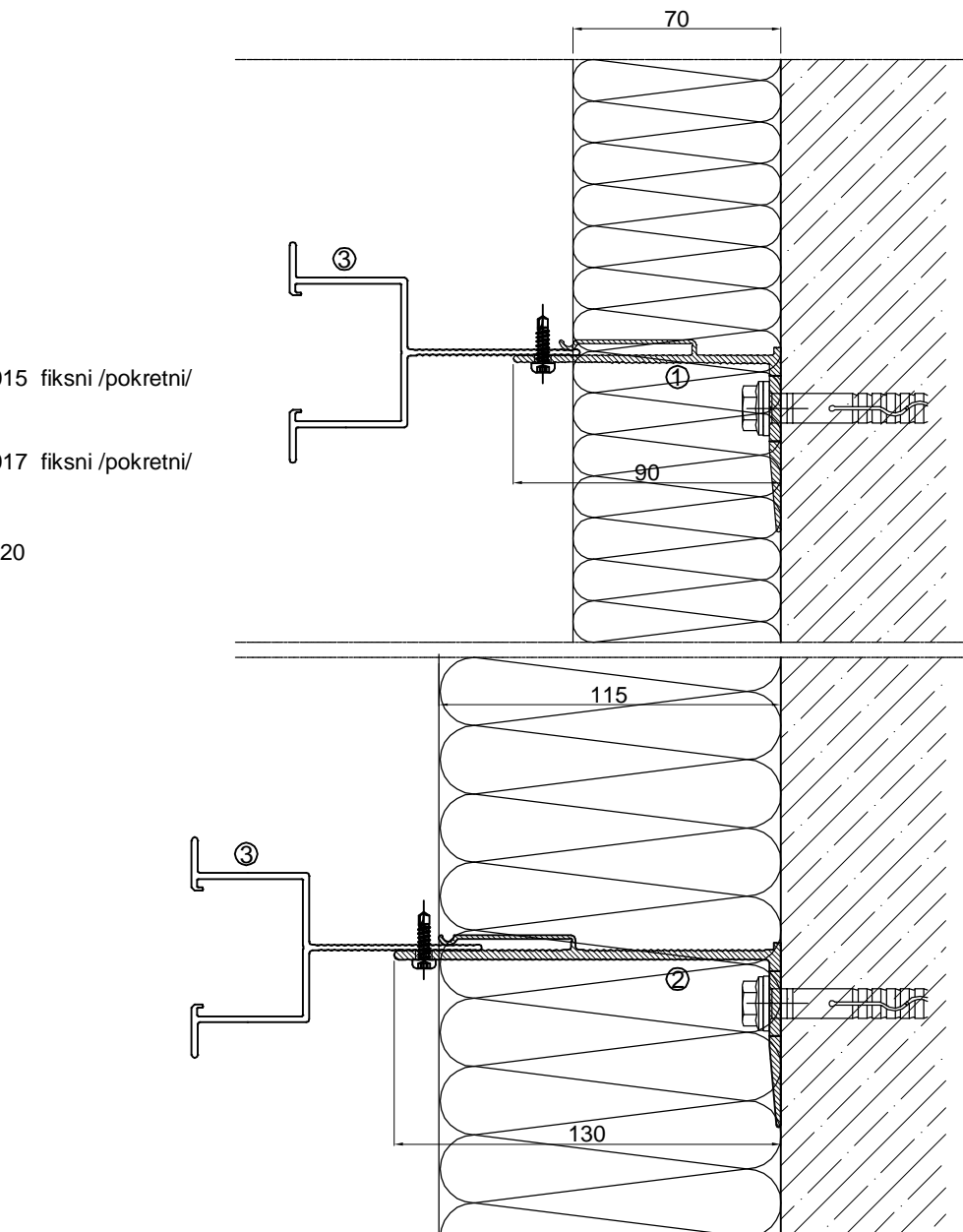

1

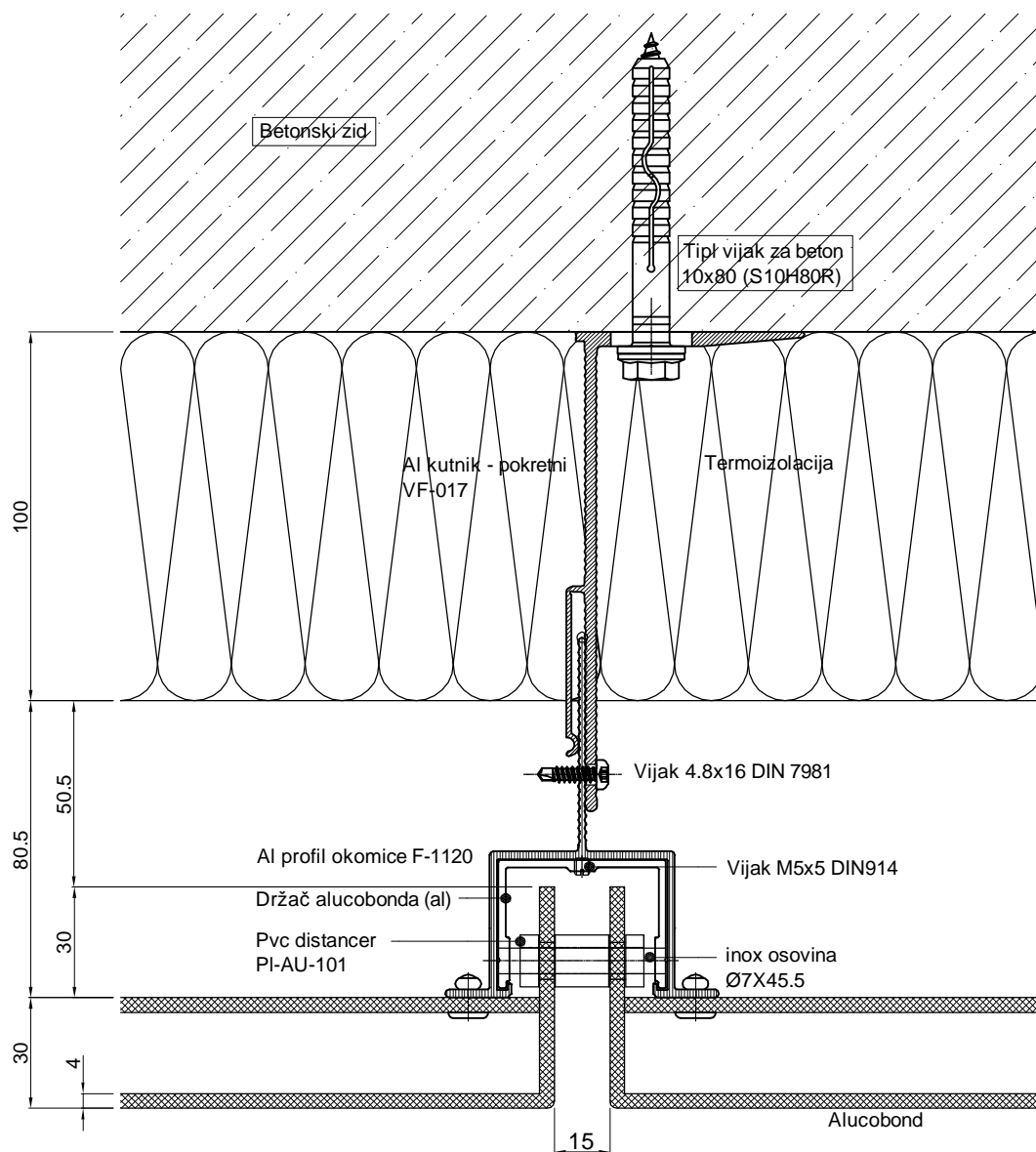

②

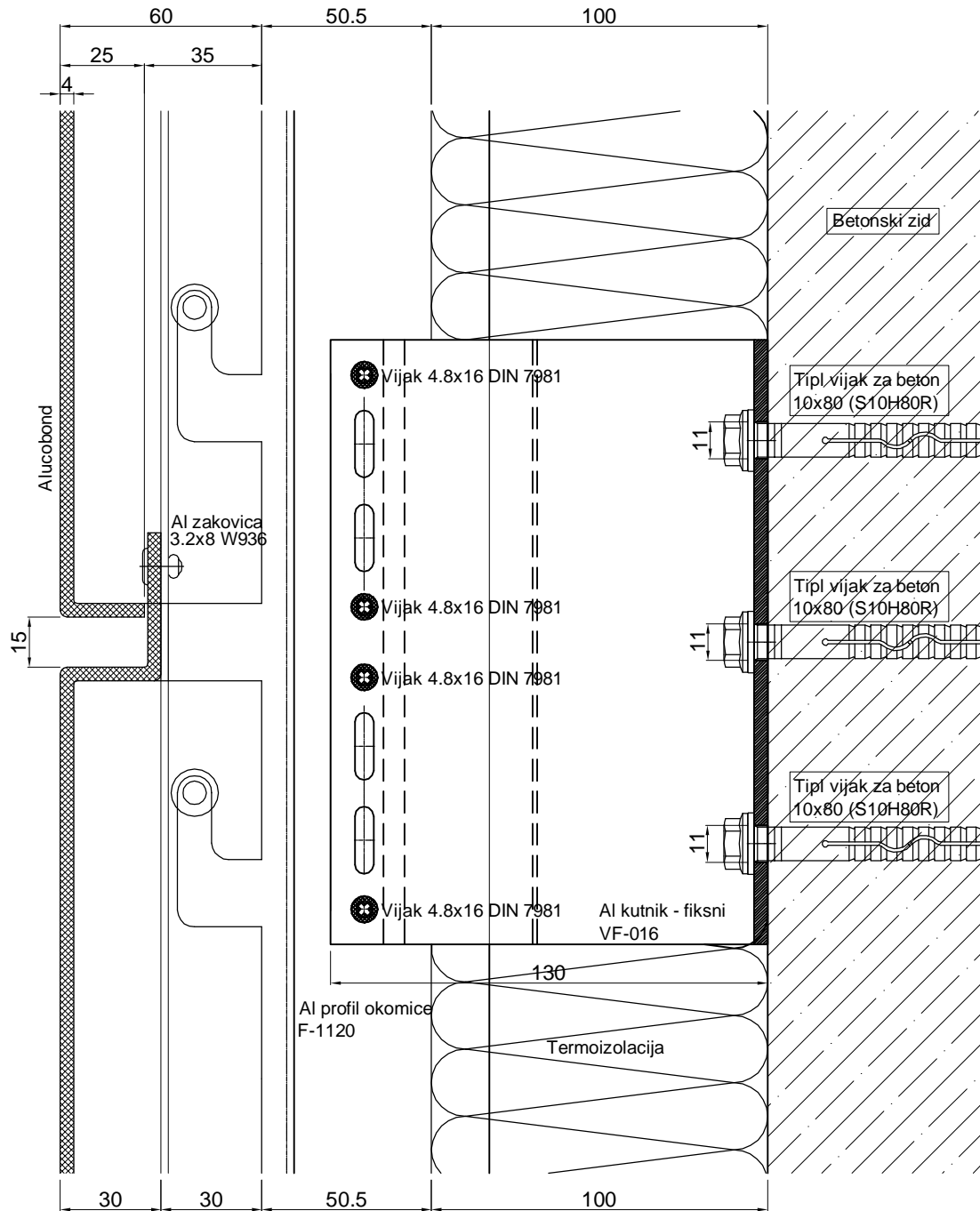

2A

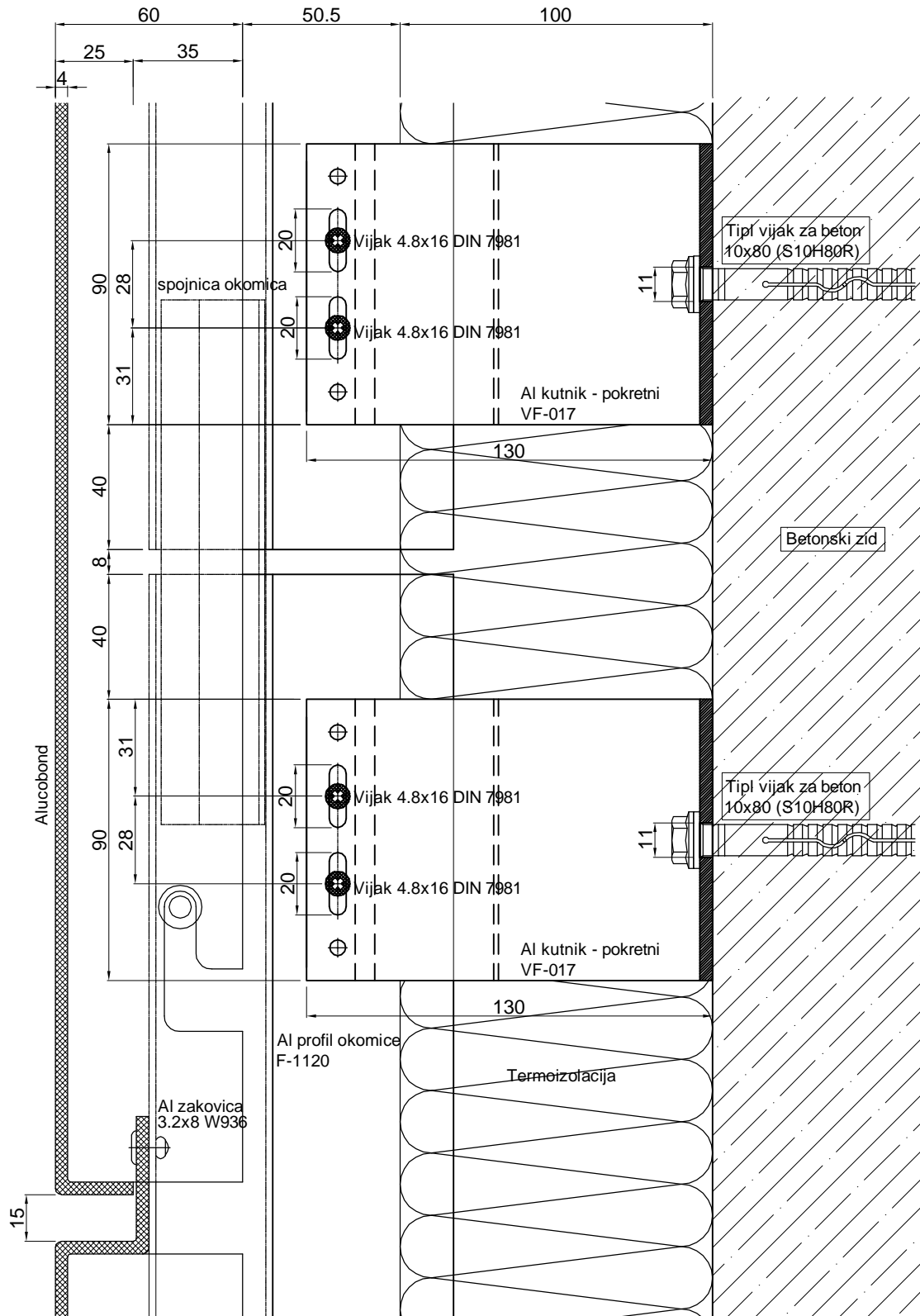

③

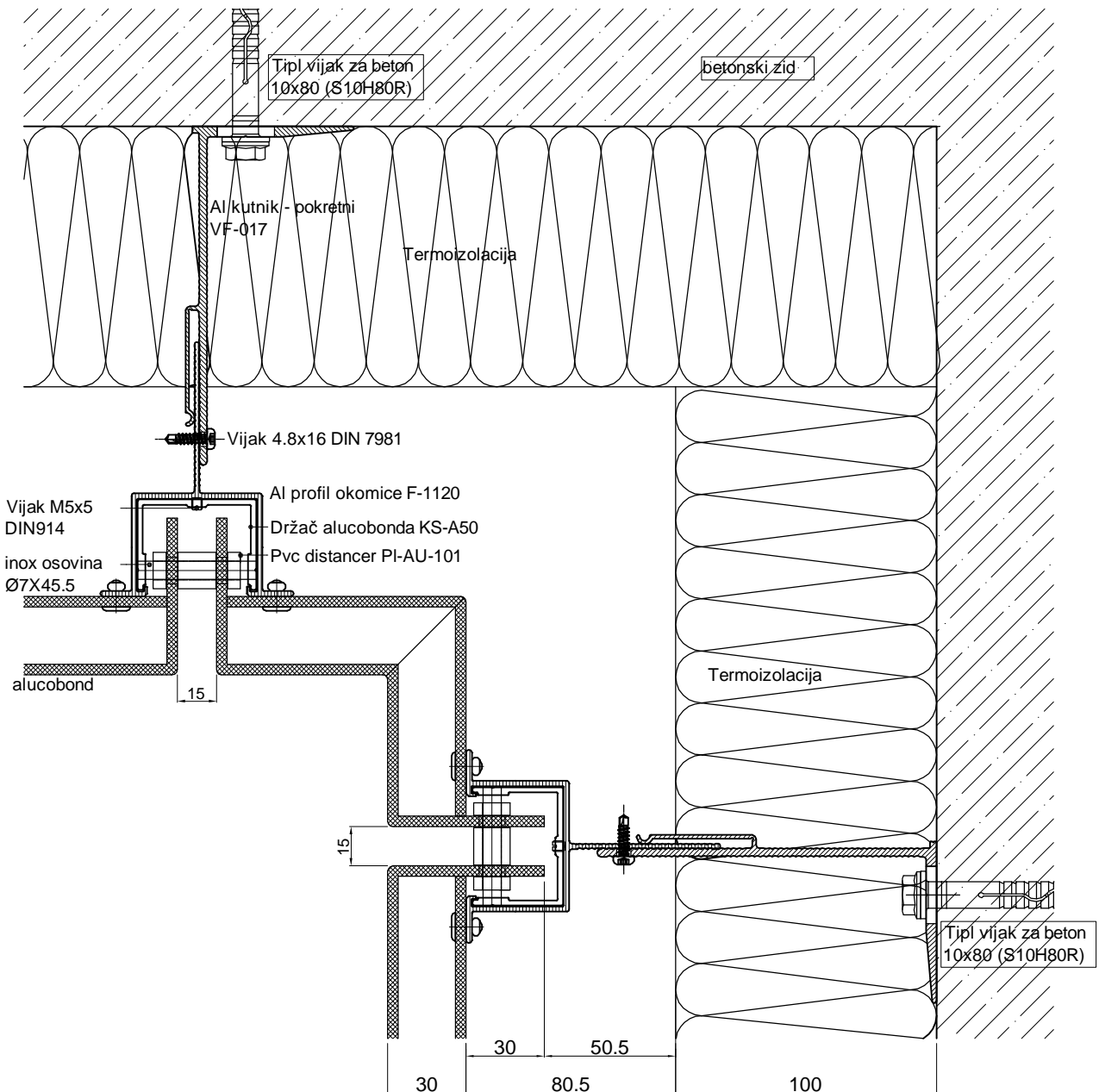

④

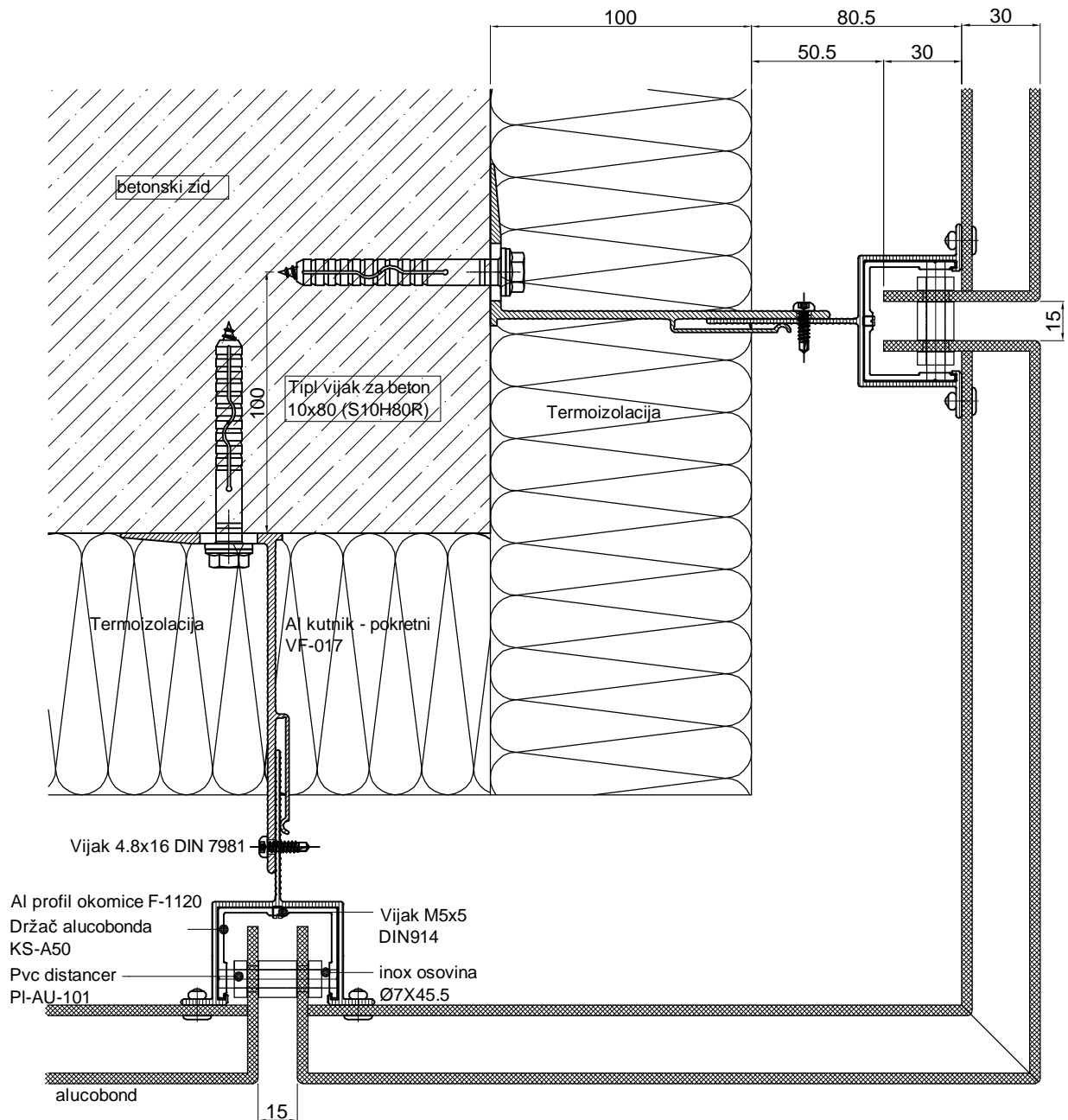

5

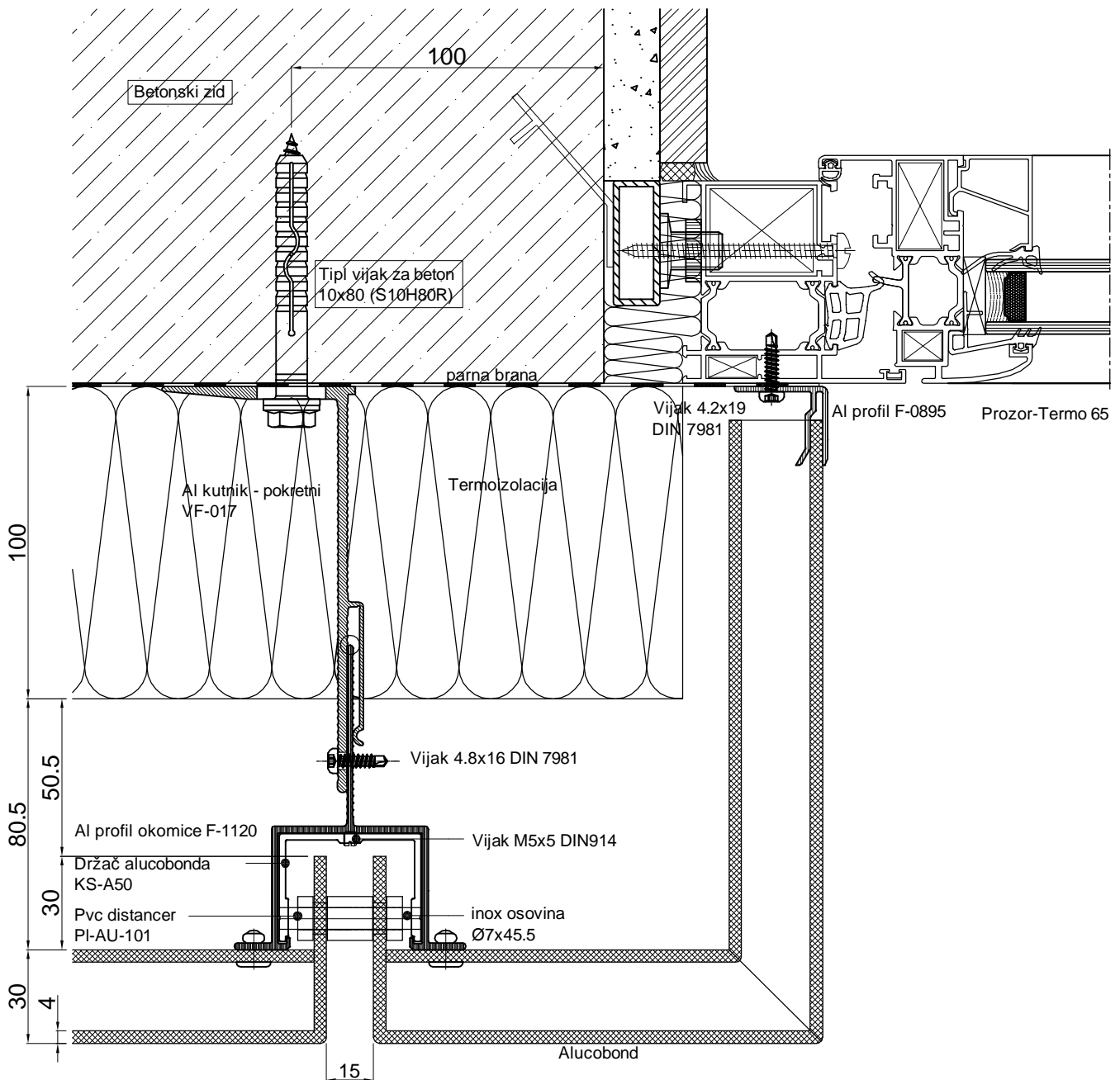

⑥

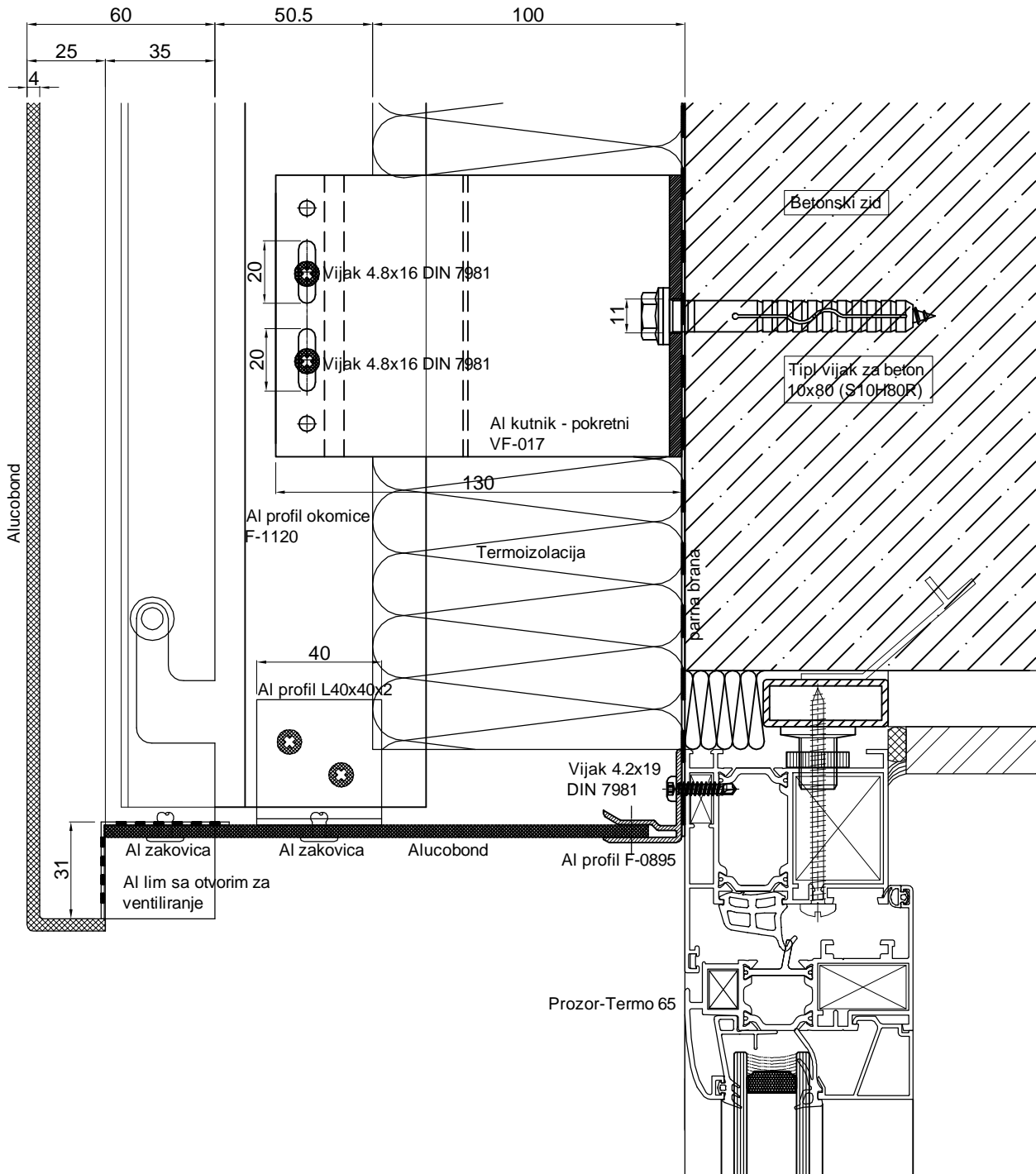

6A

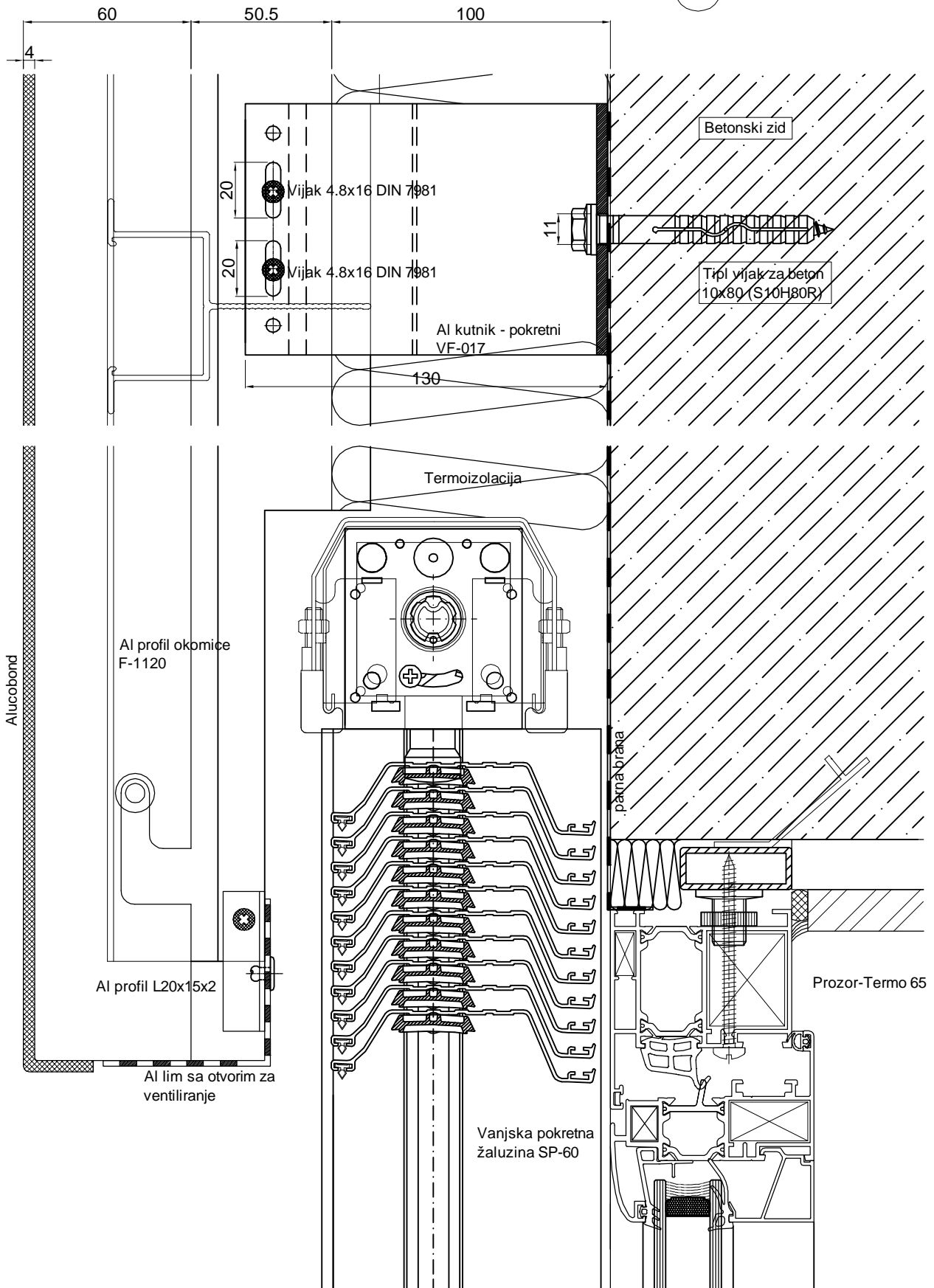

7

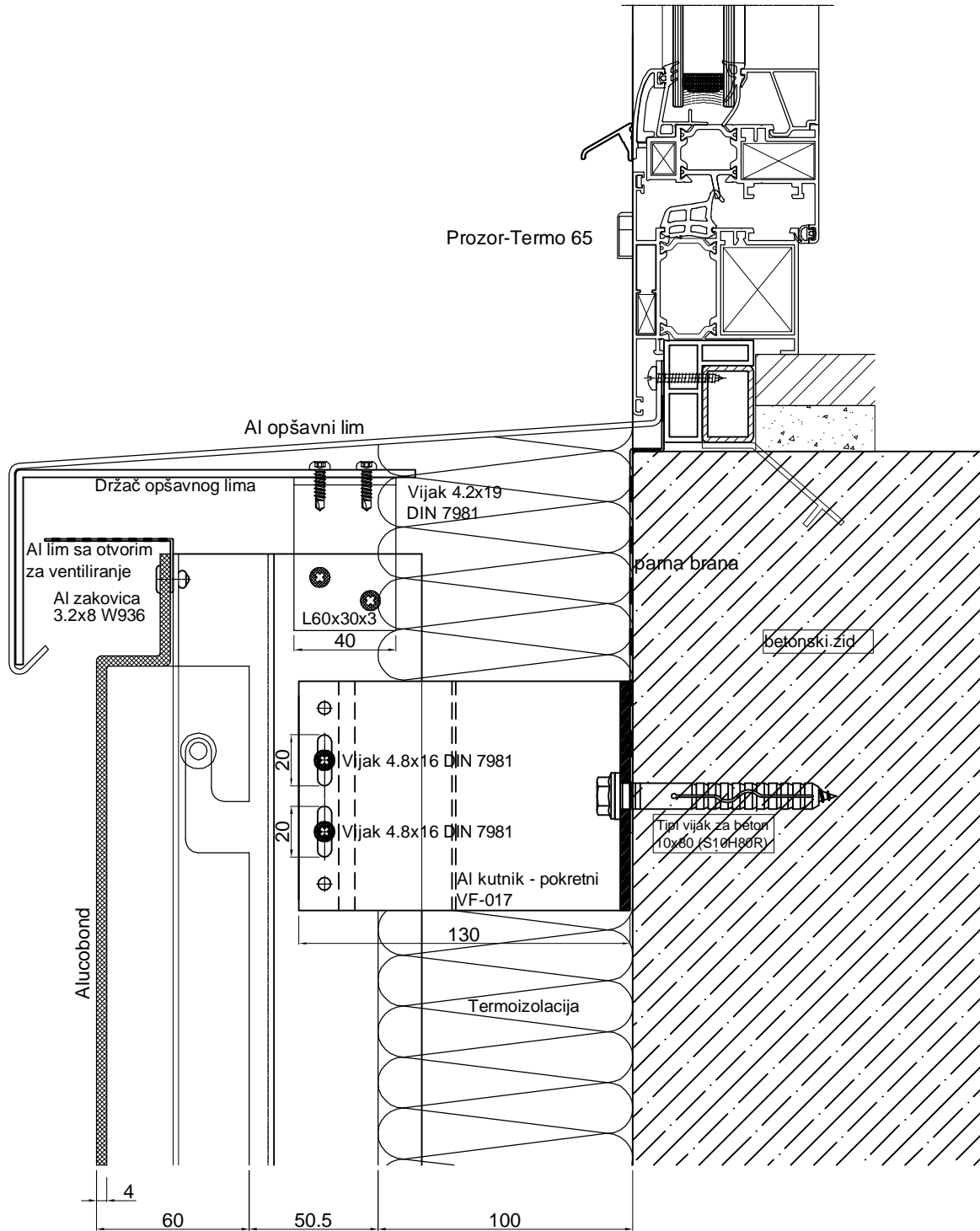

8

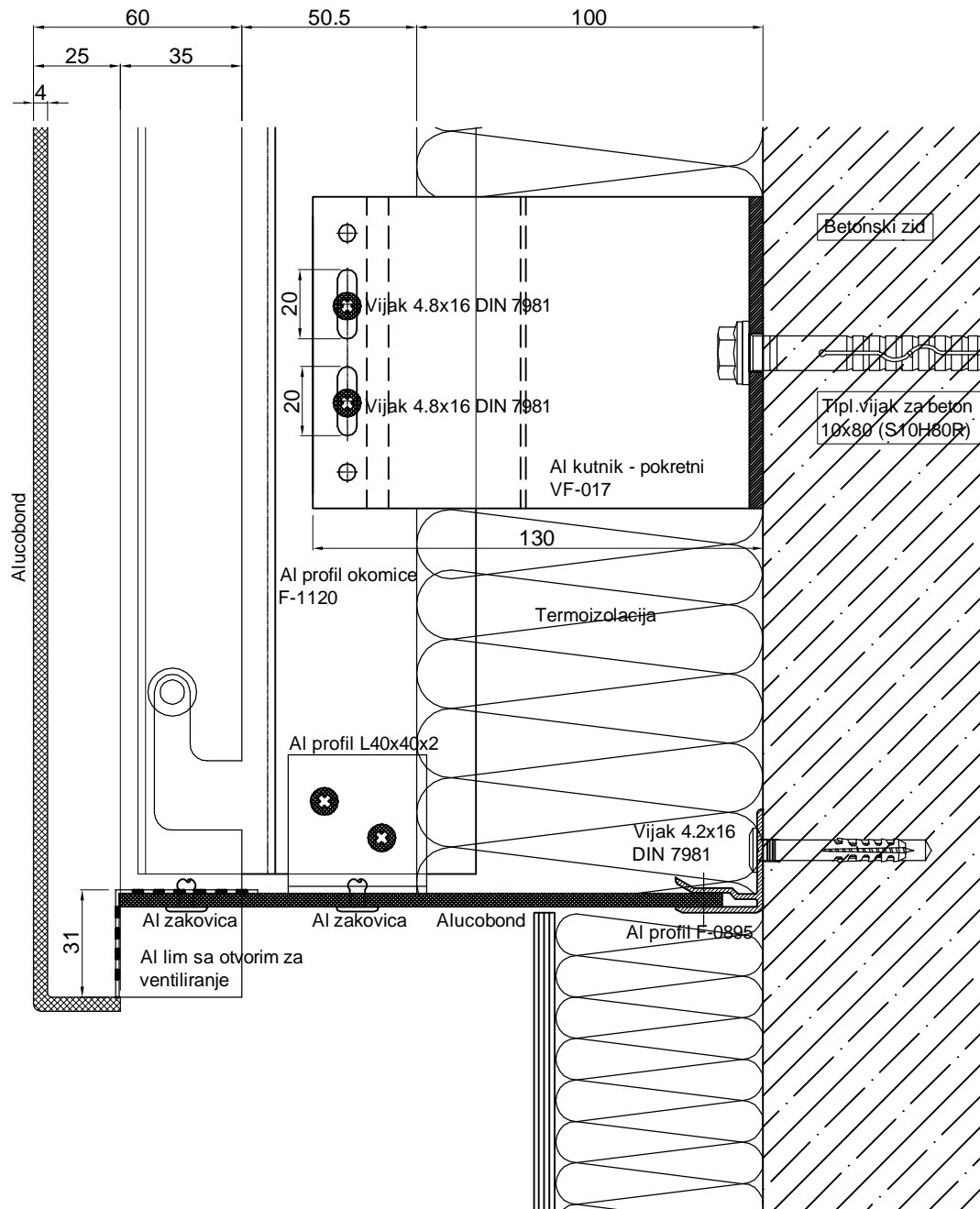

9

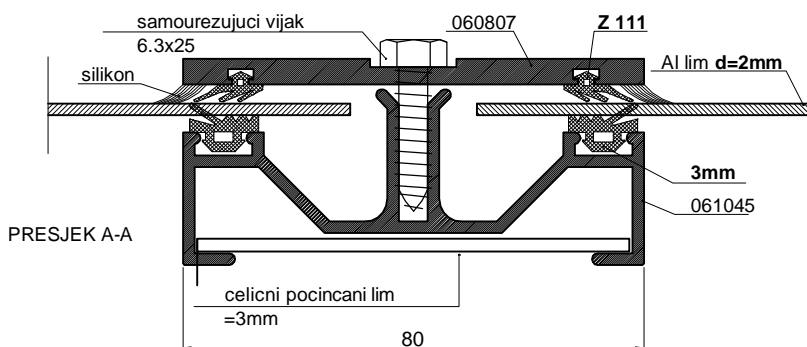
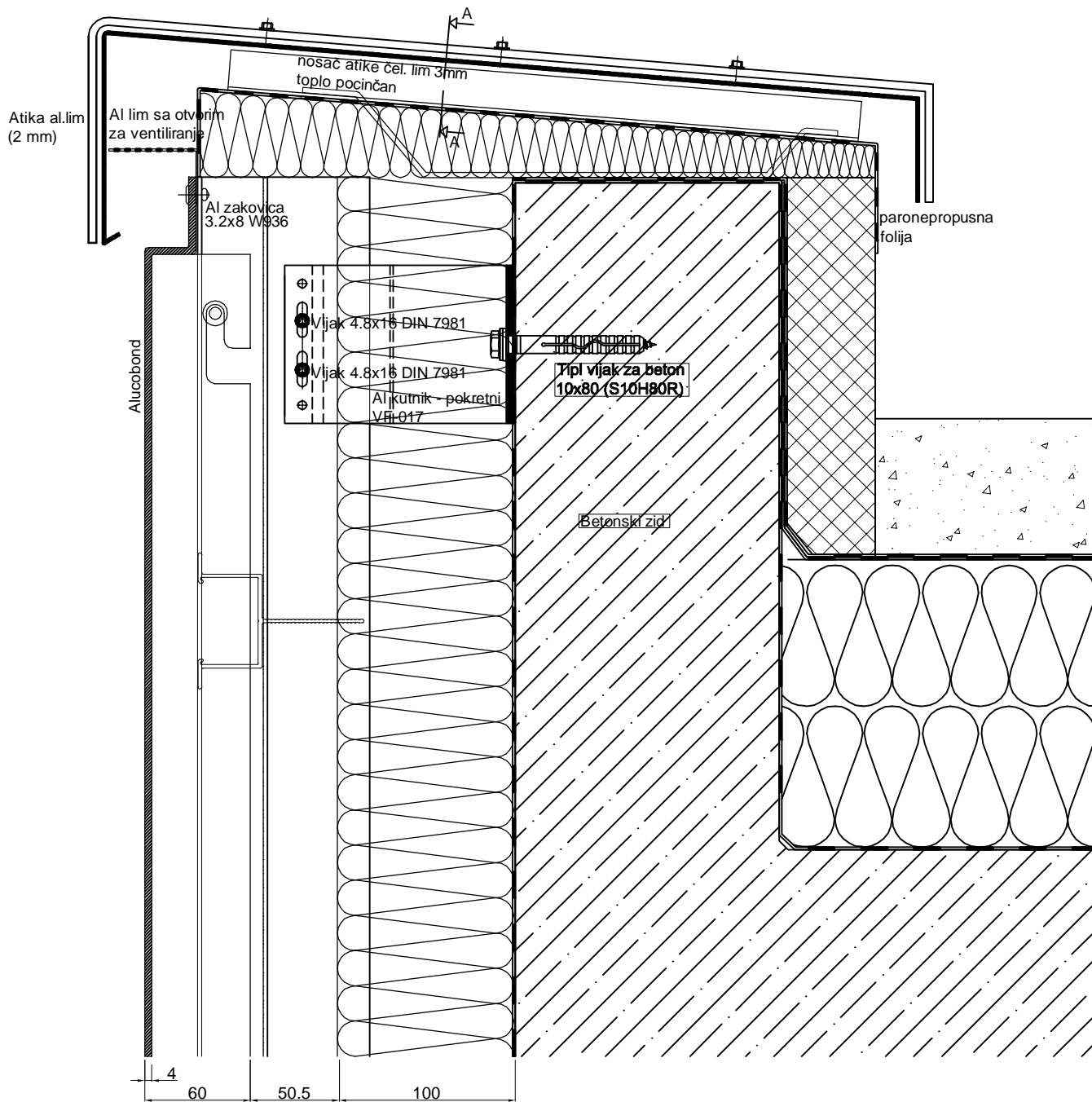

10

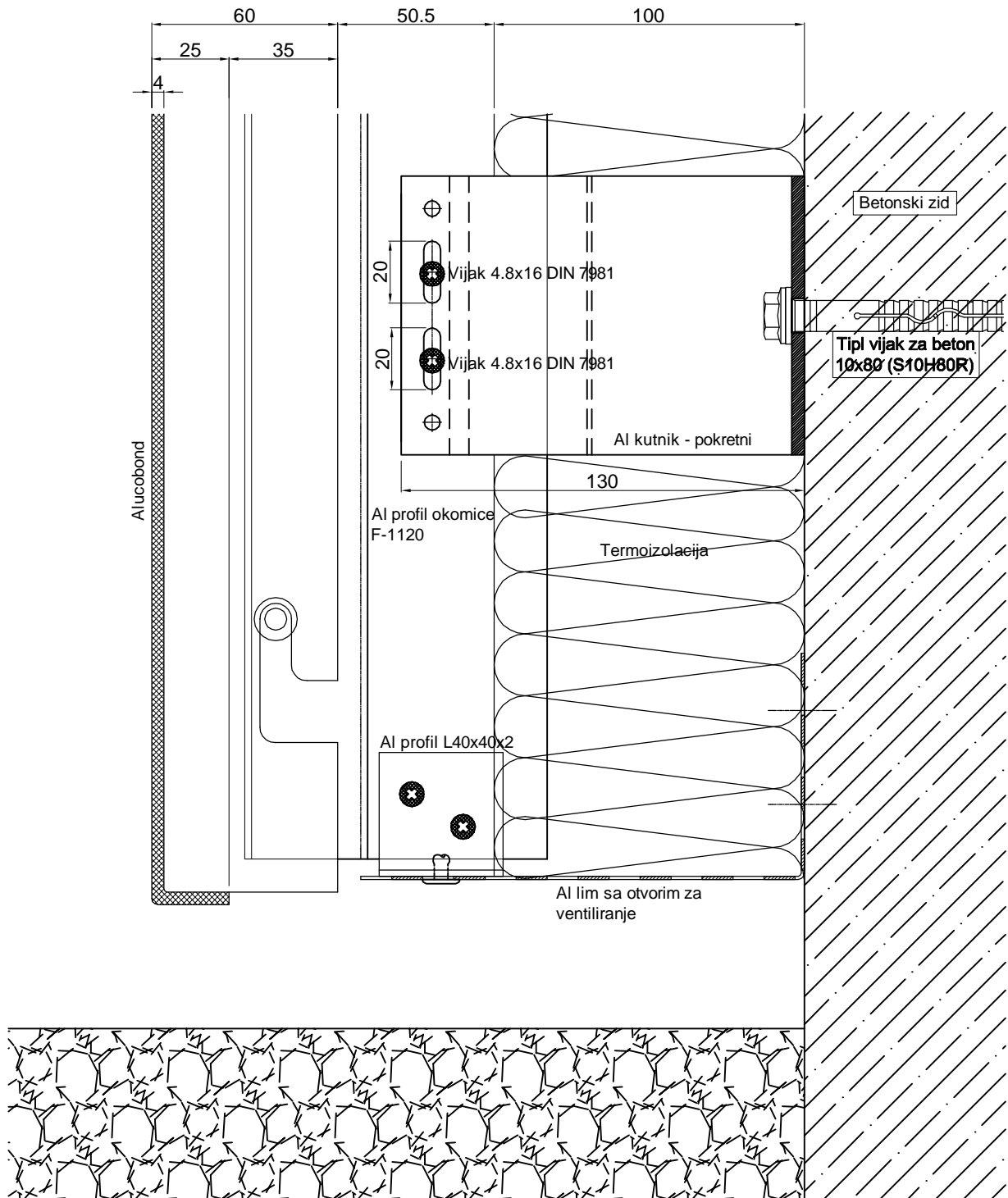

①

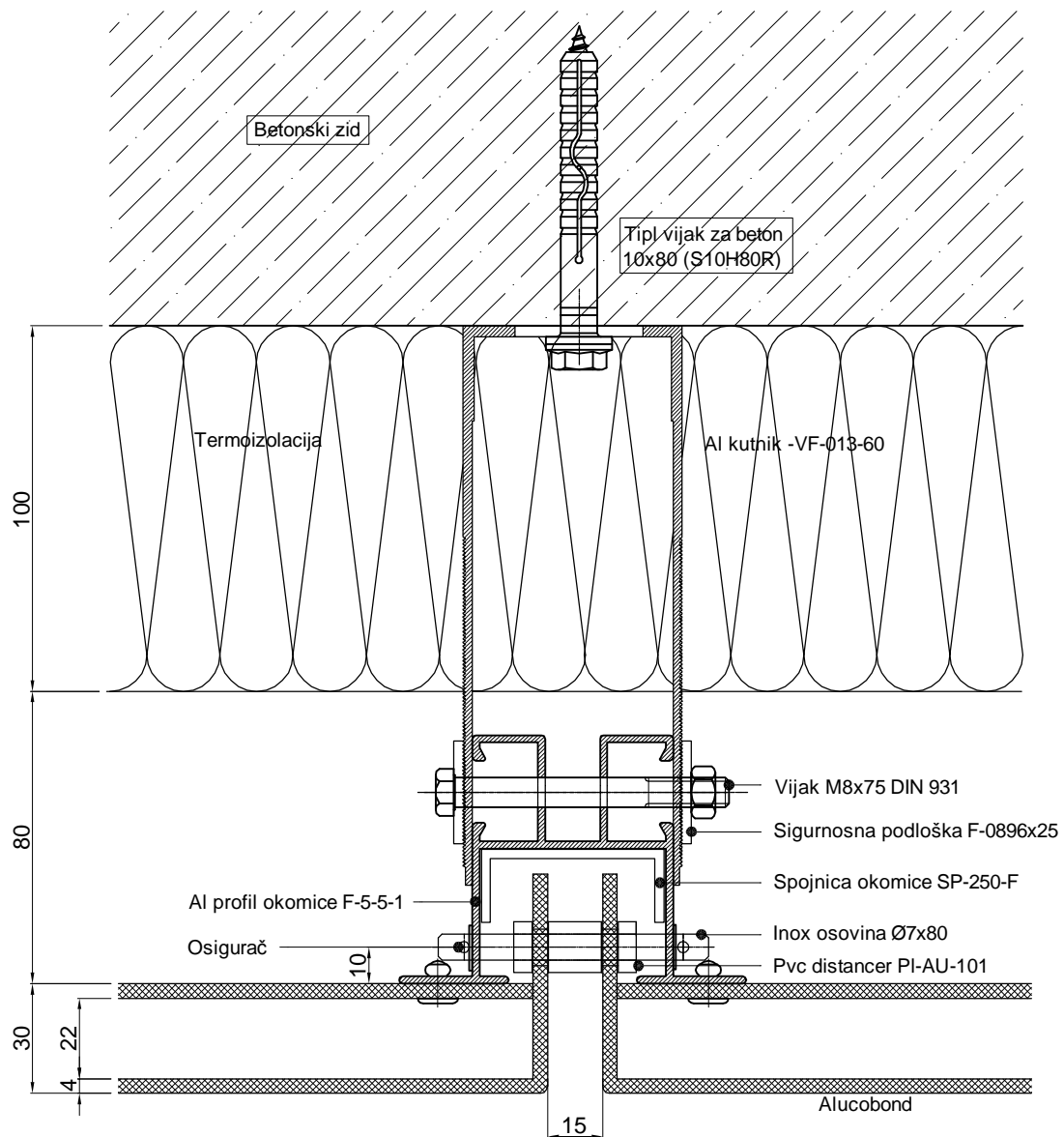

②

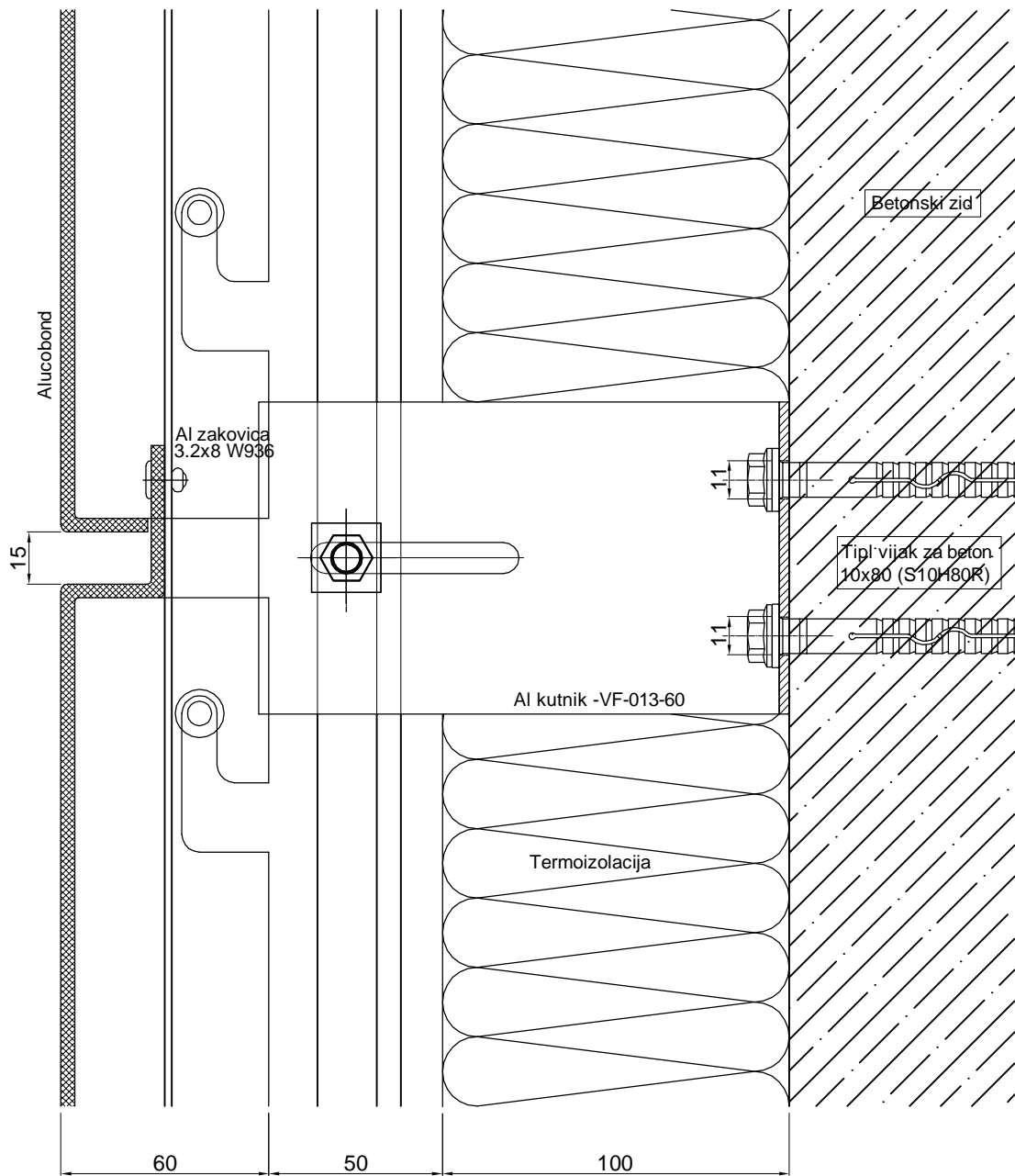

VENTILIRAJUĆE
FASADNE OBLOGE

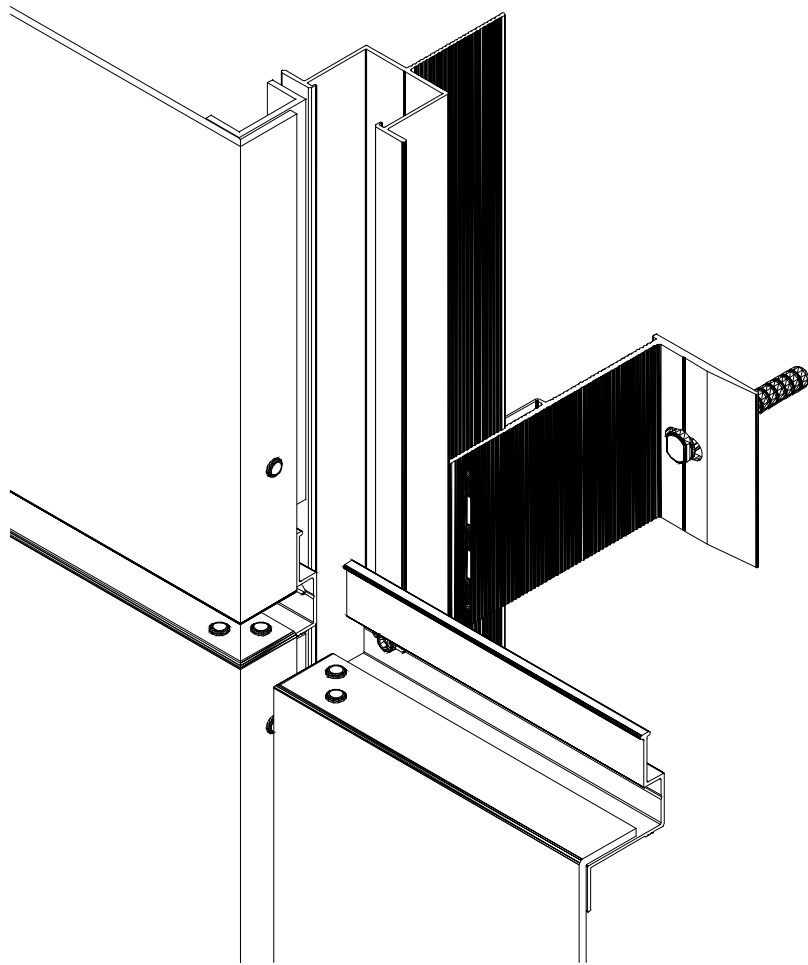

ALUCOBOND FASADA A-2

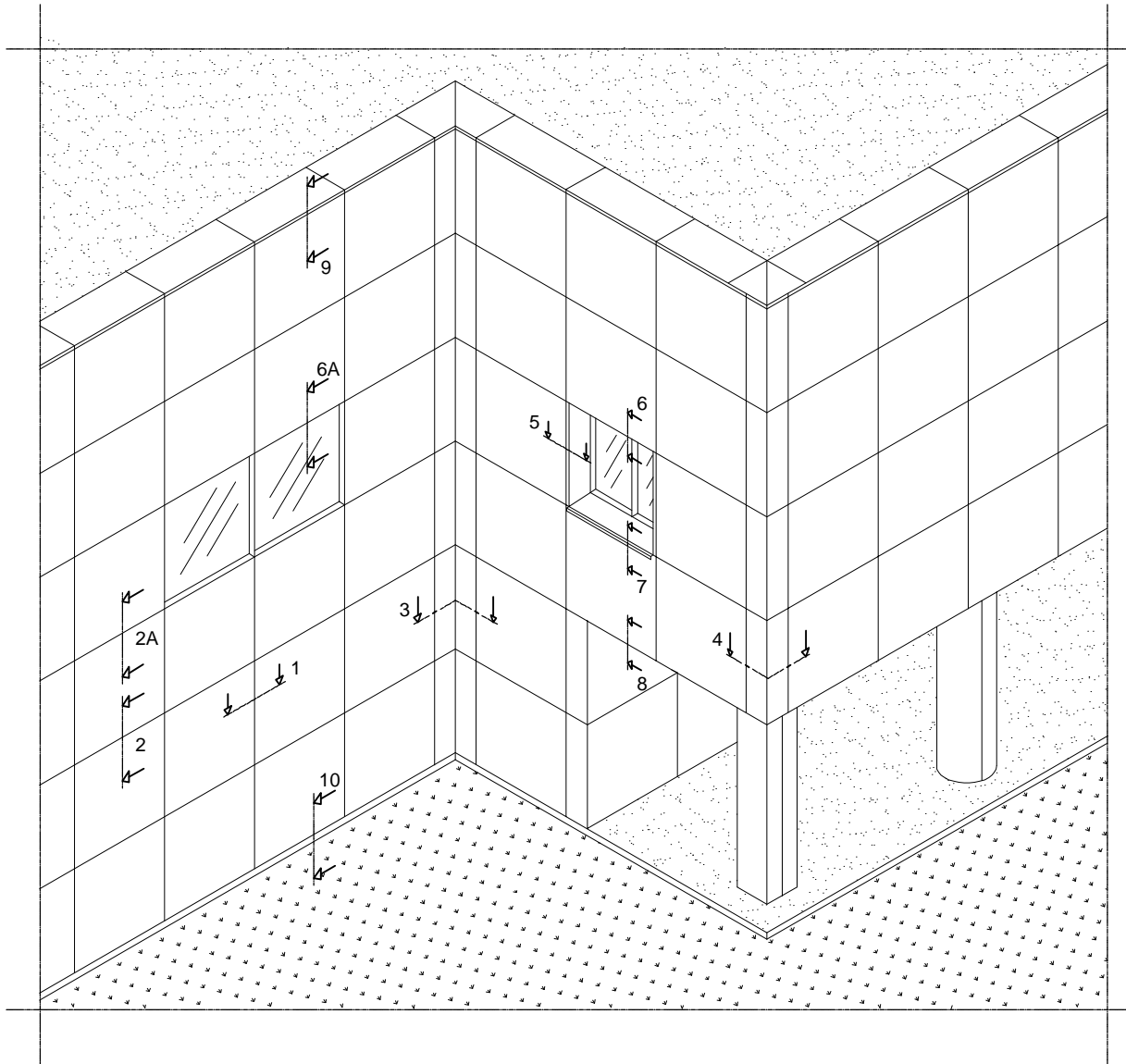

1

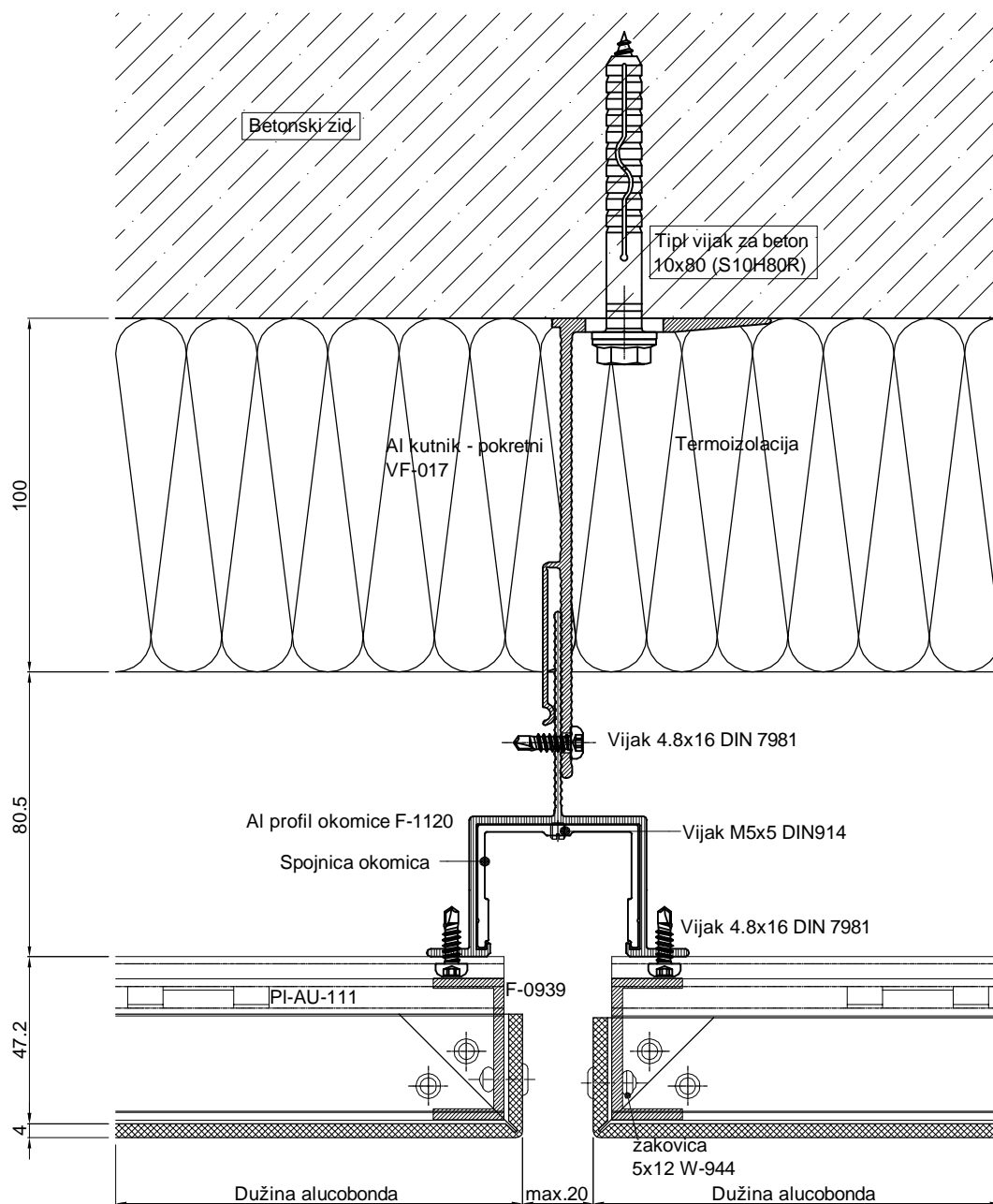

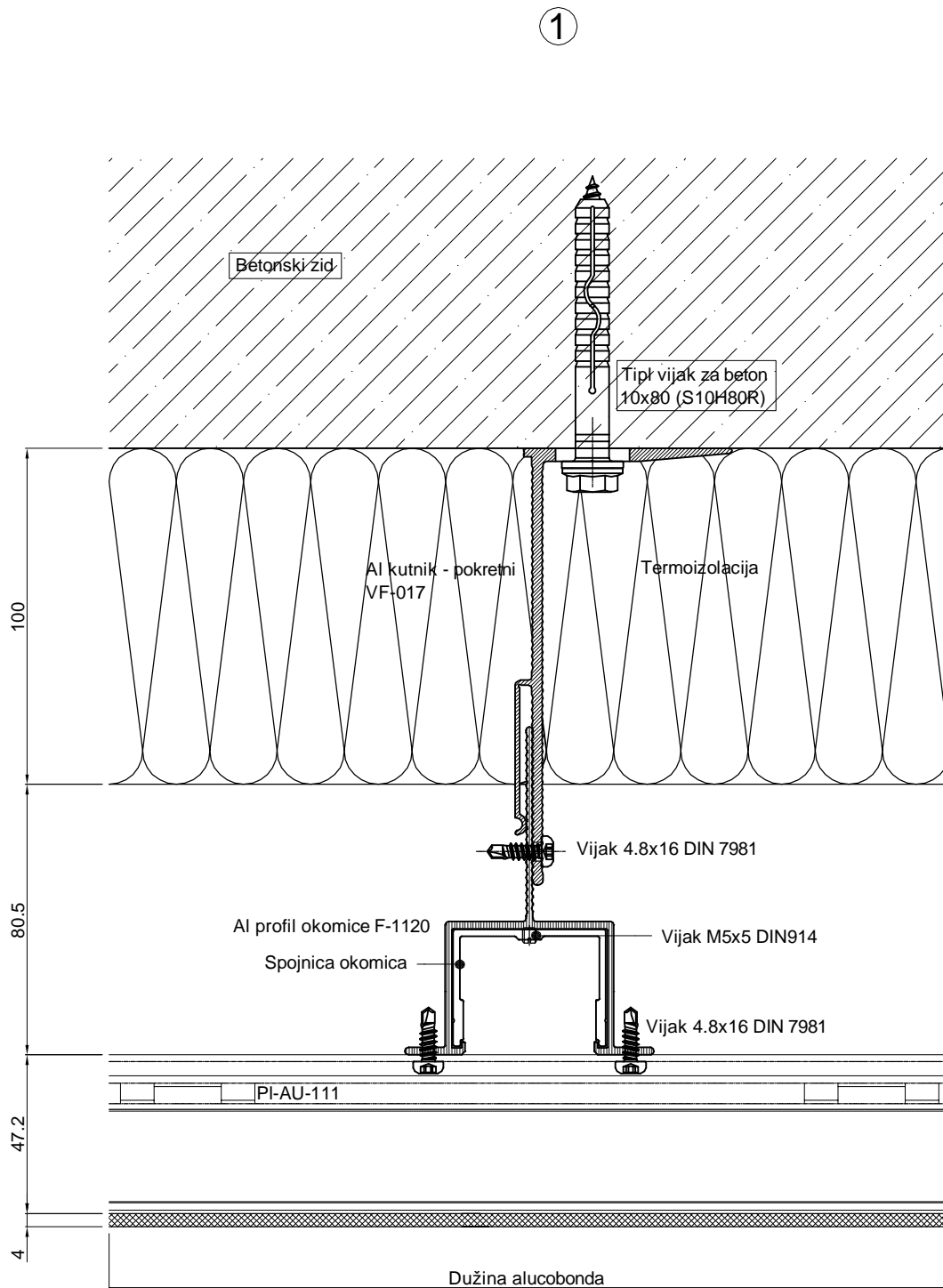

②

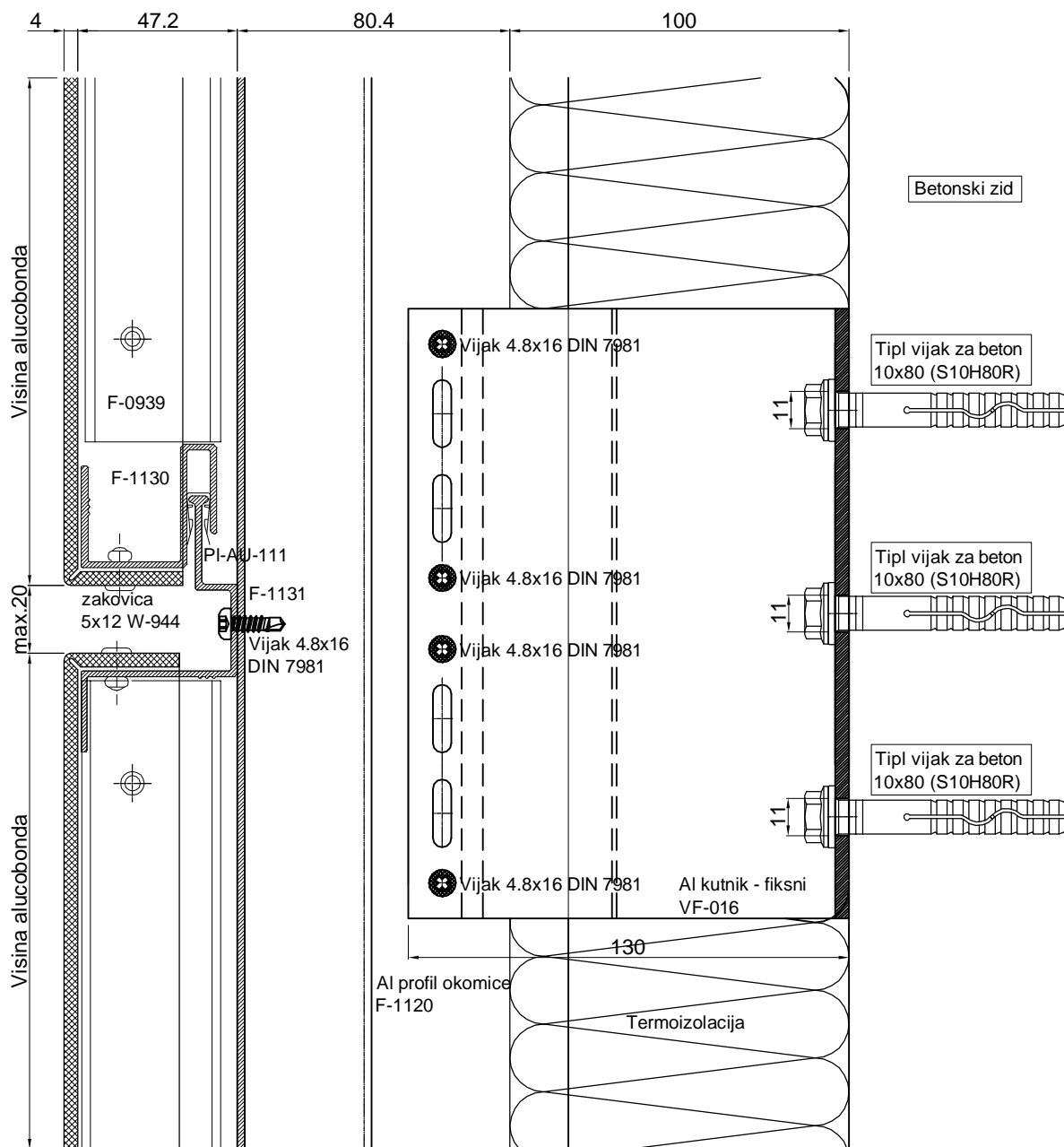

2A

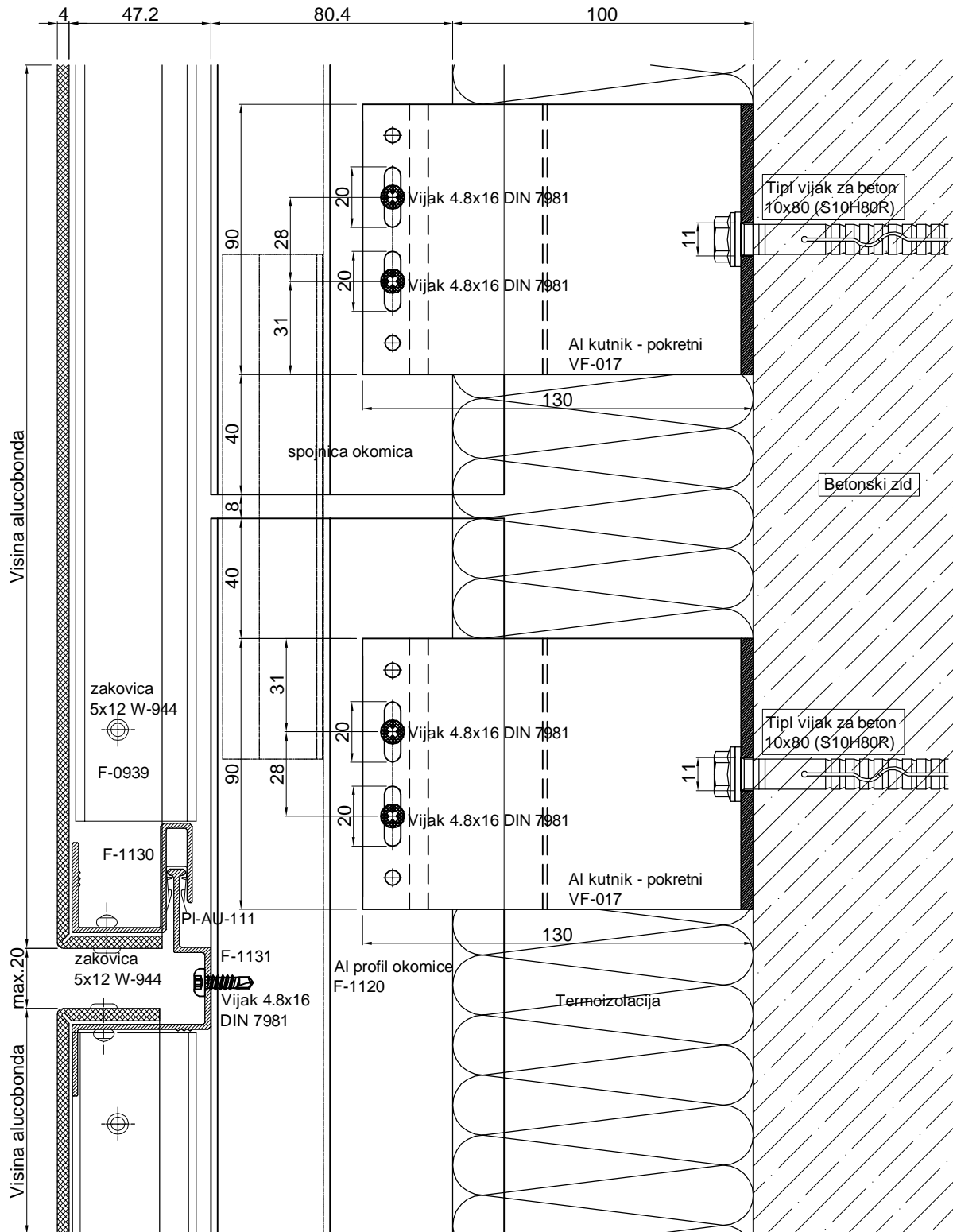

③

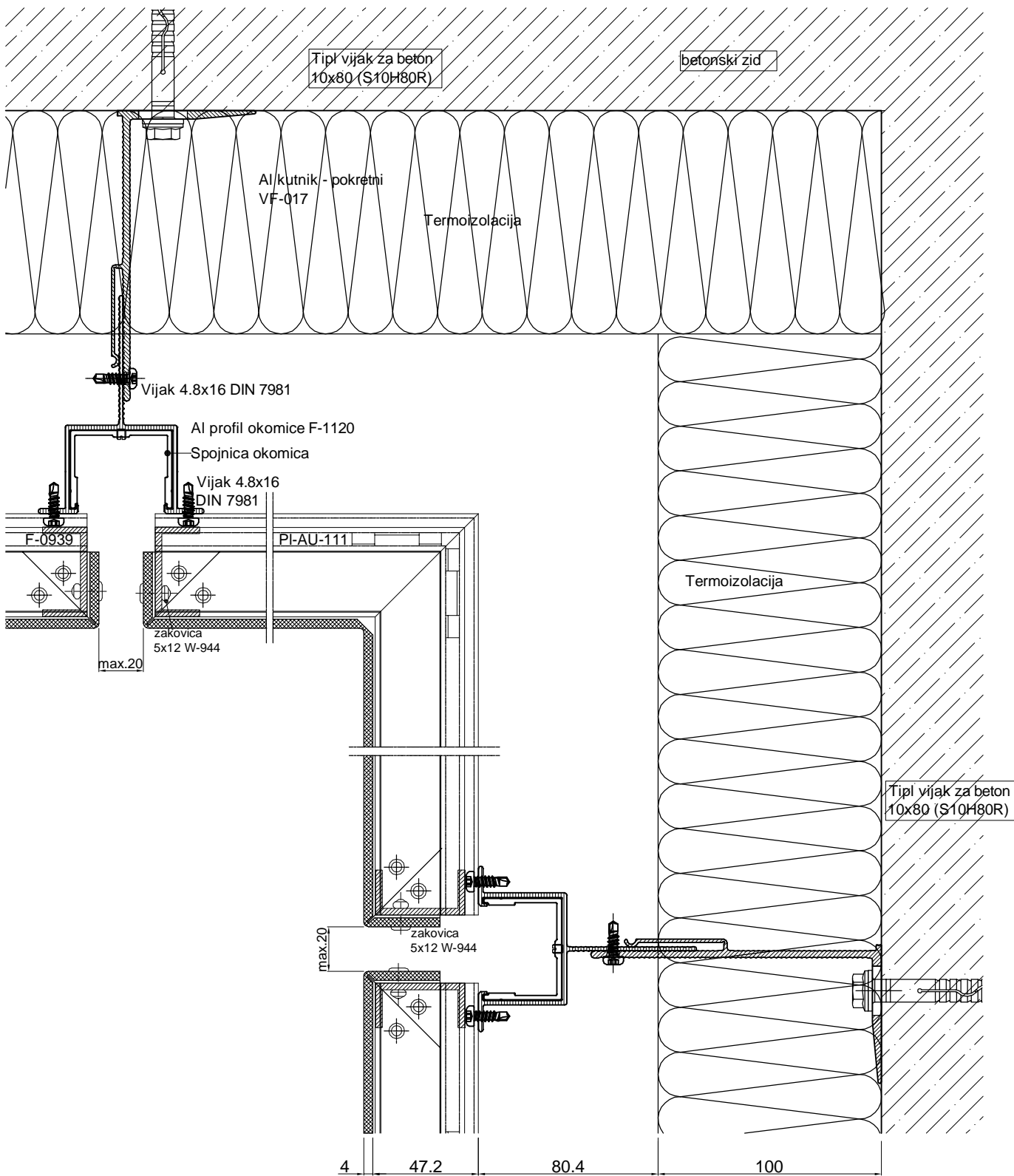

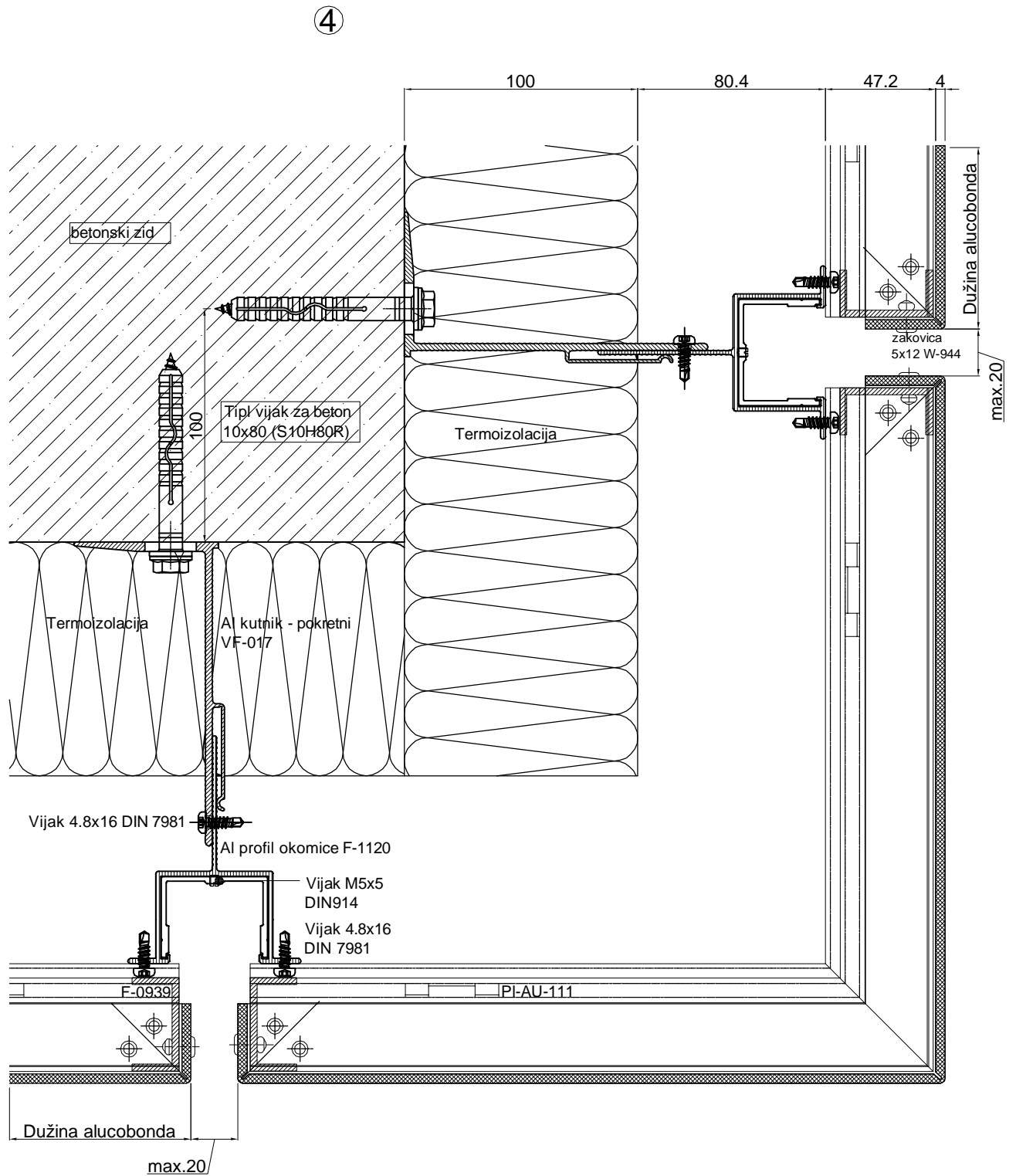

5

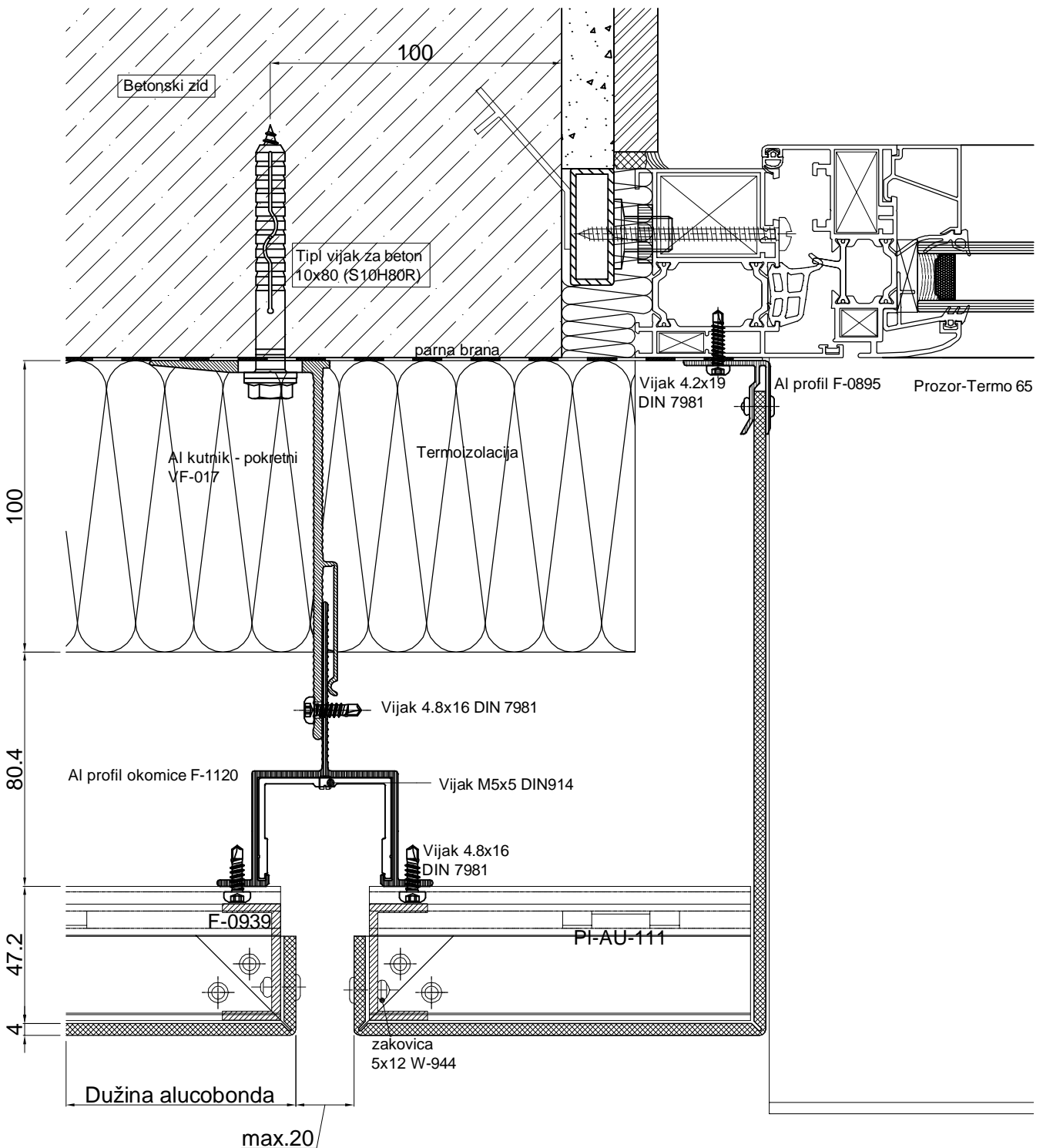

⑥

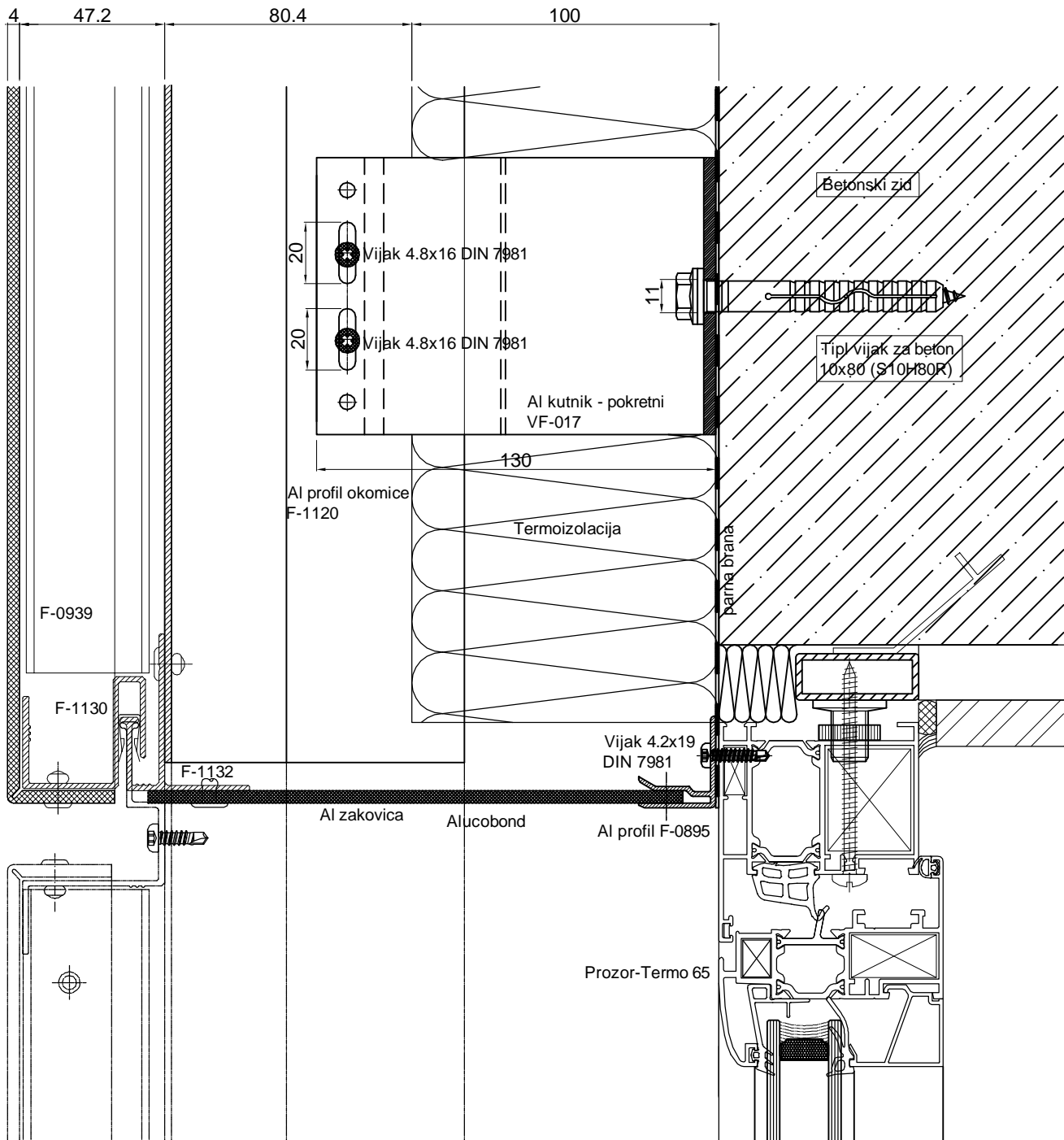

6A

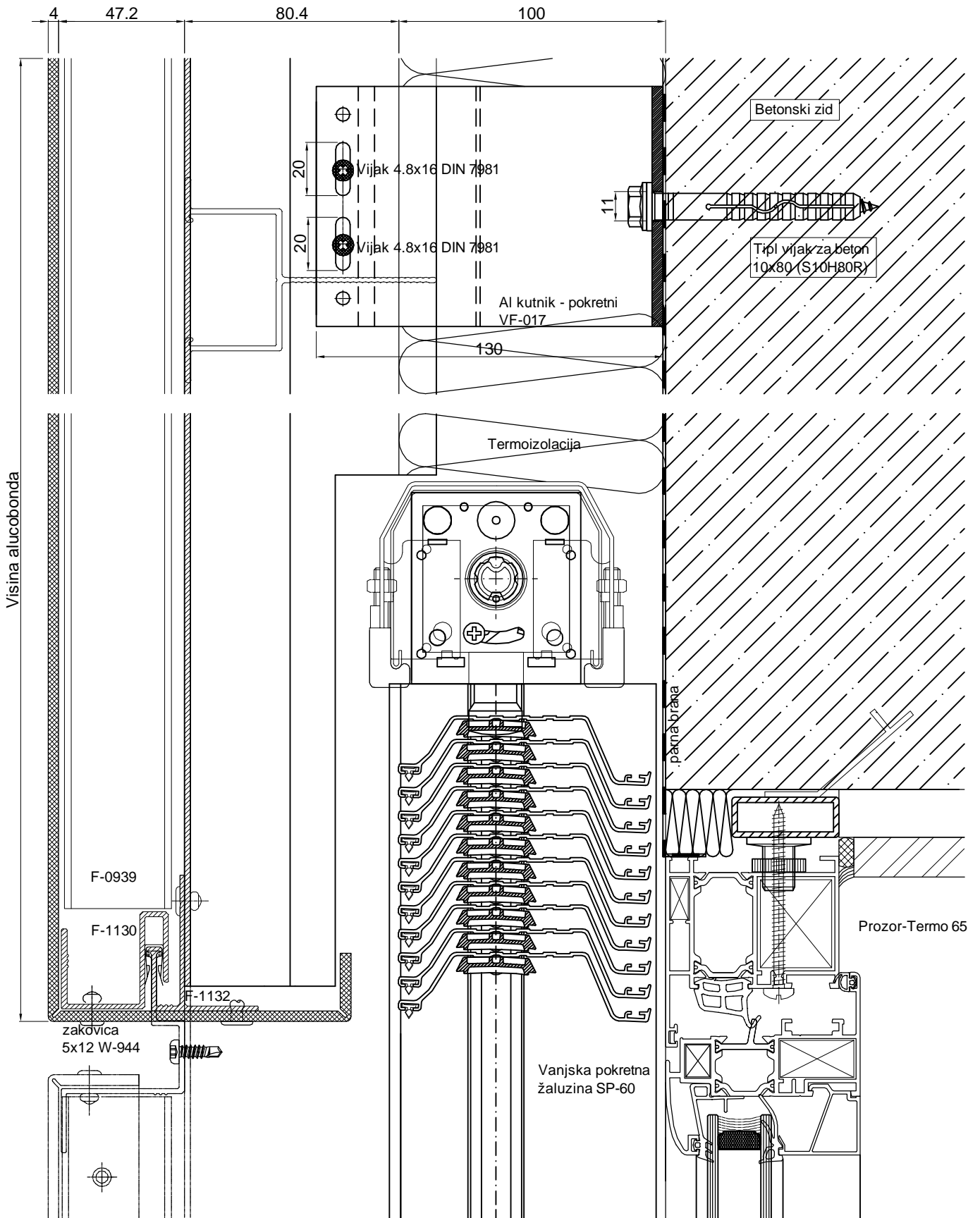

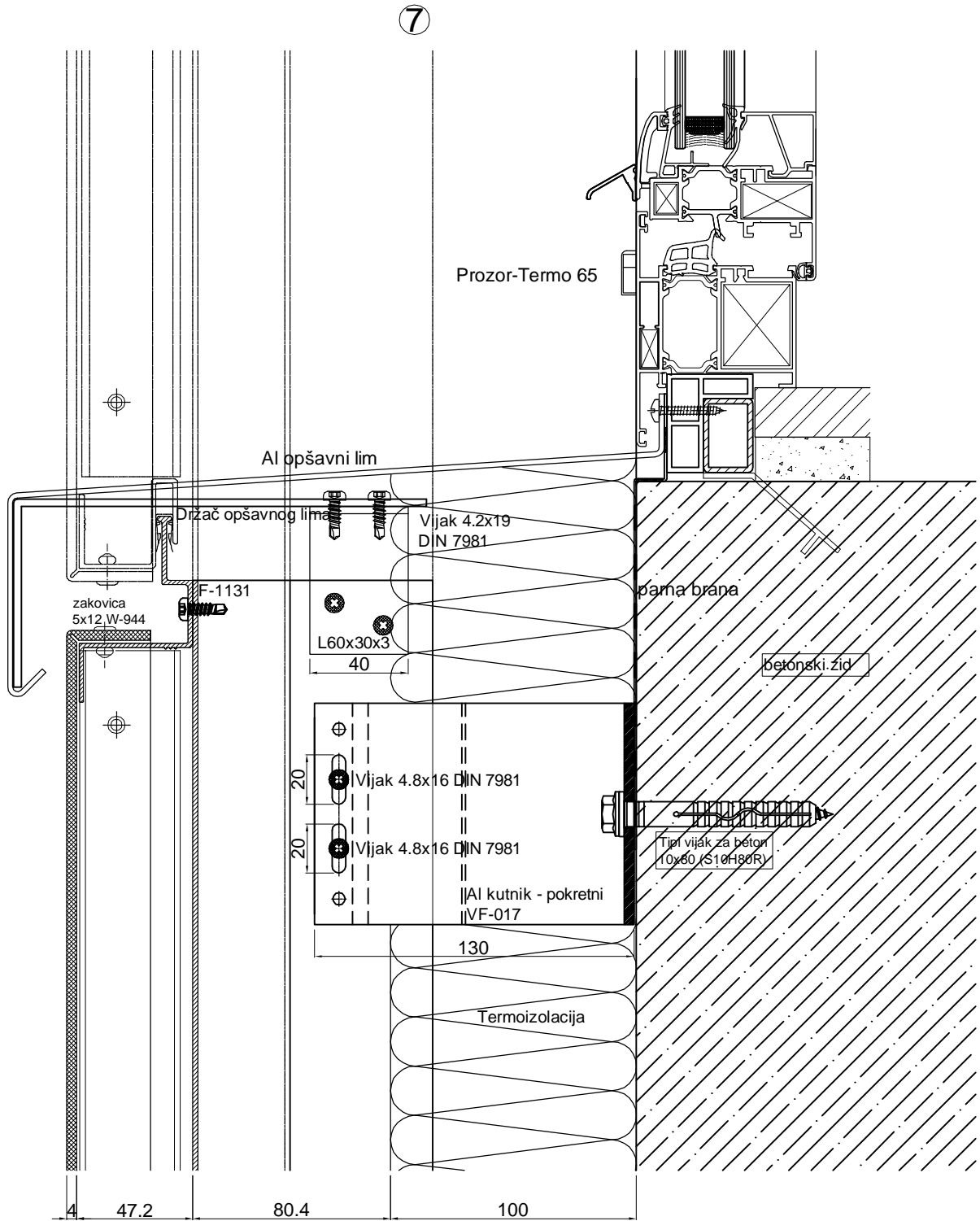

8

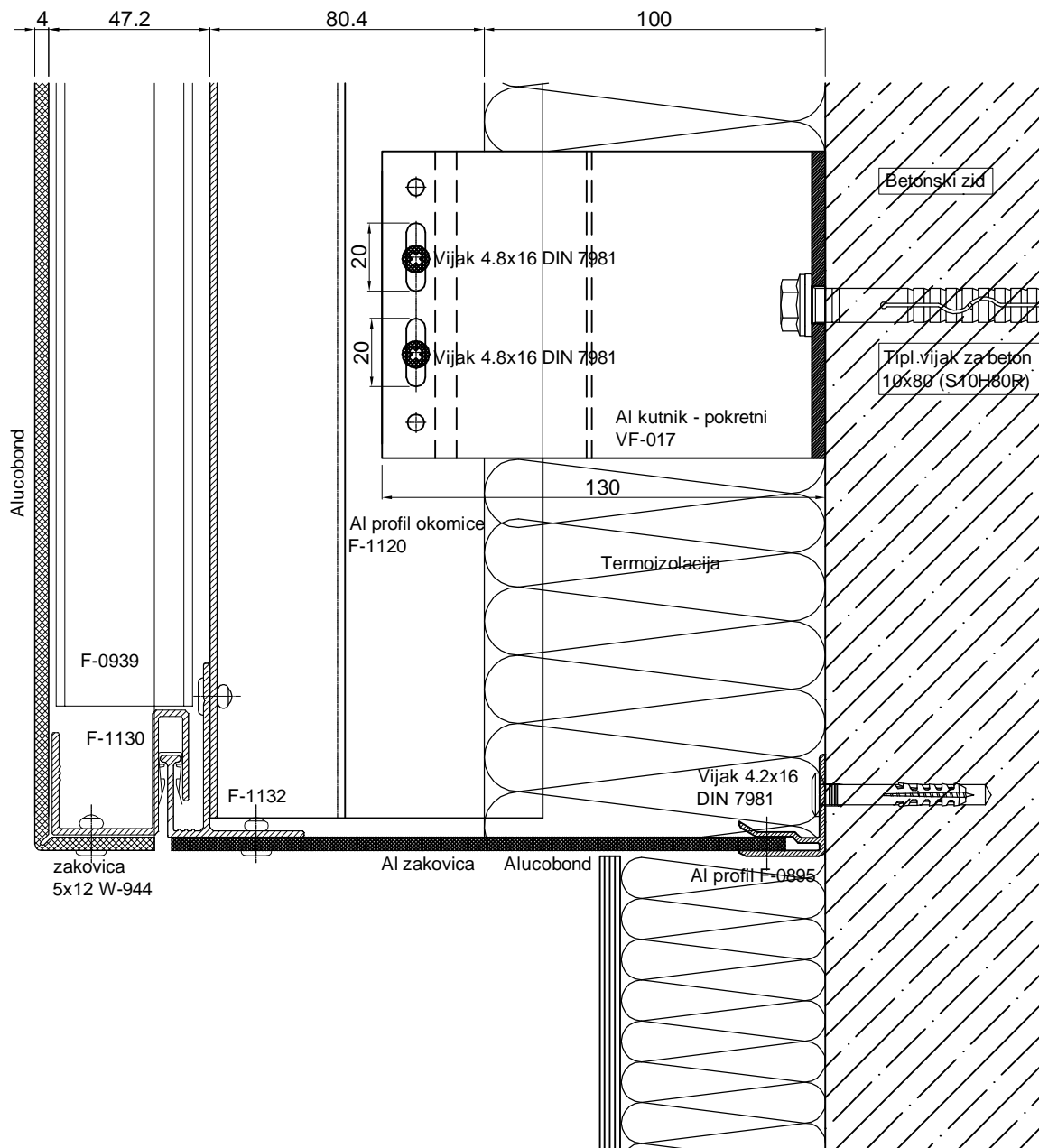

9

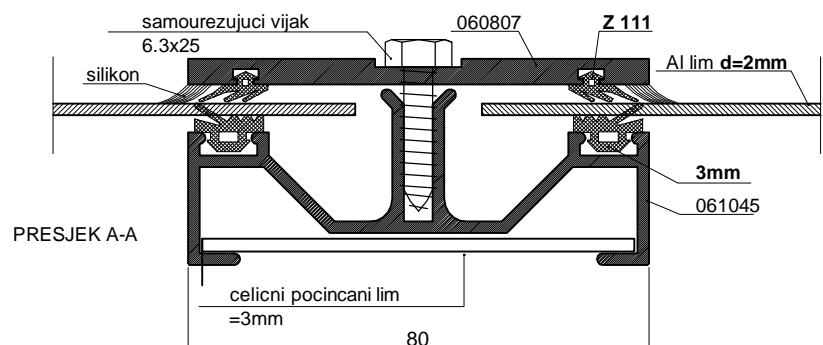
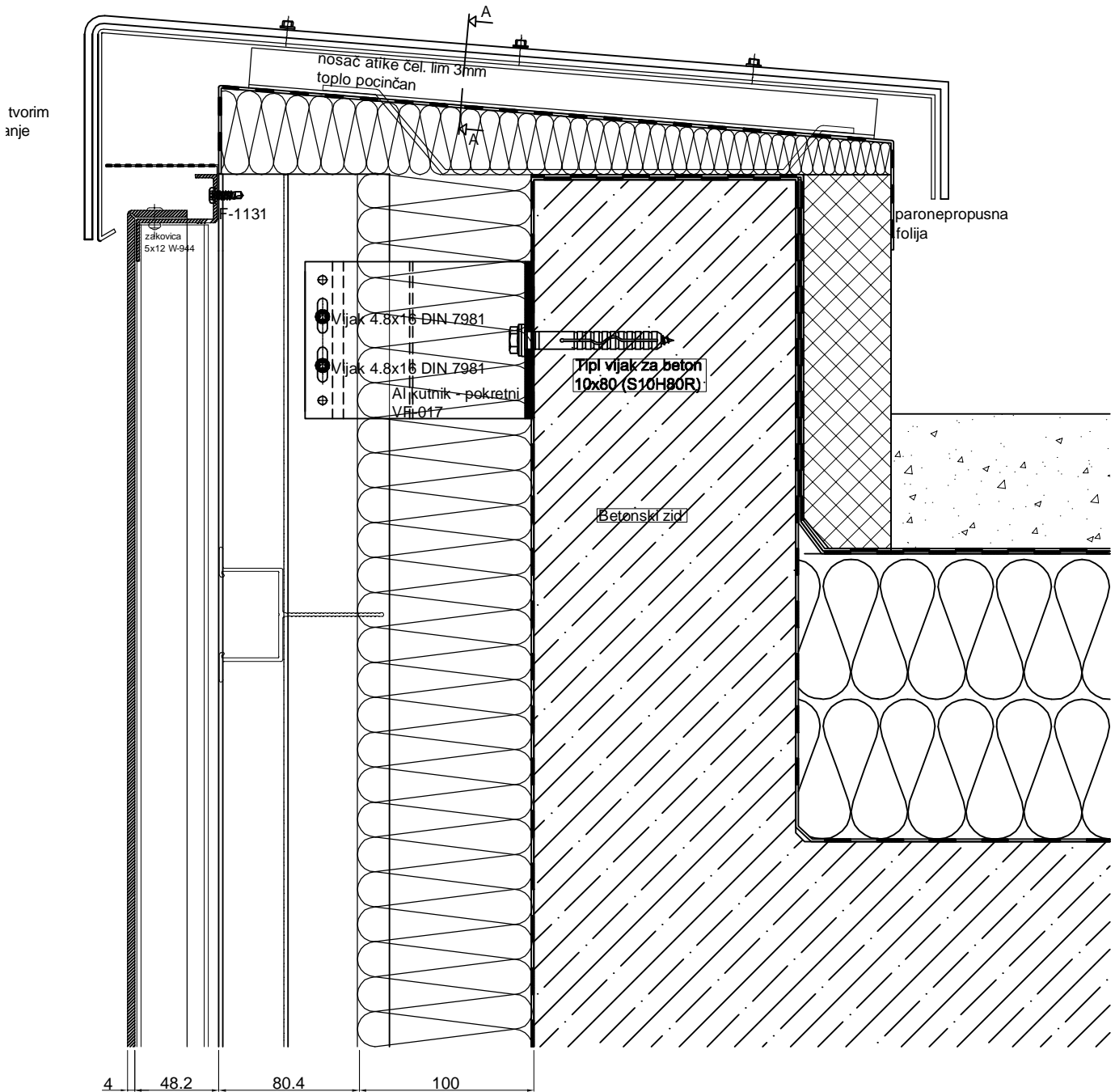

10

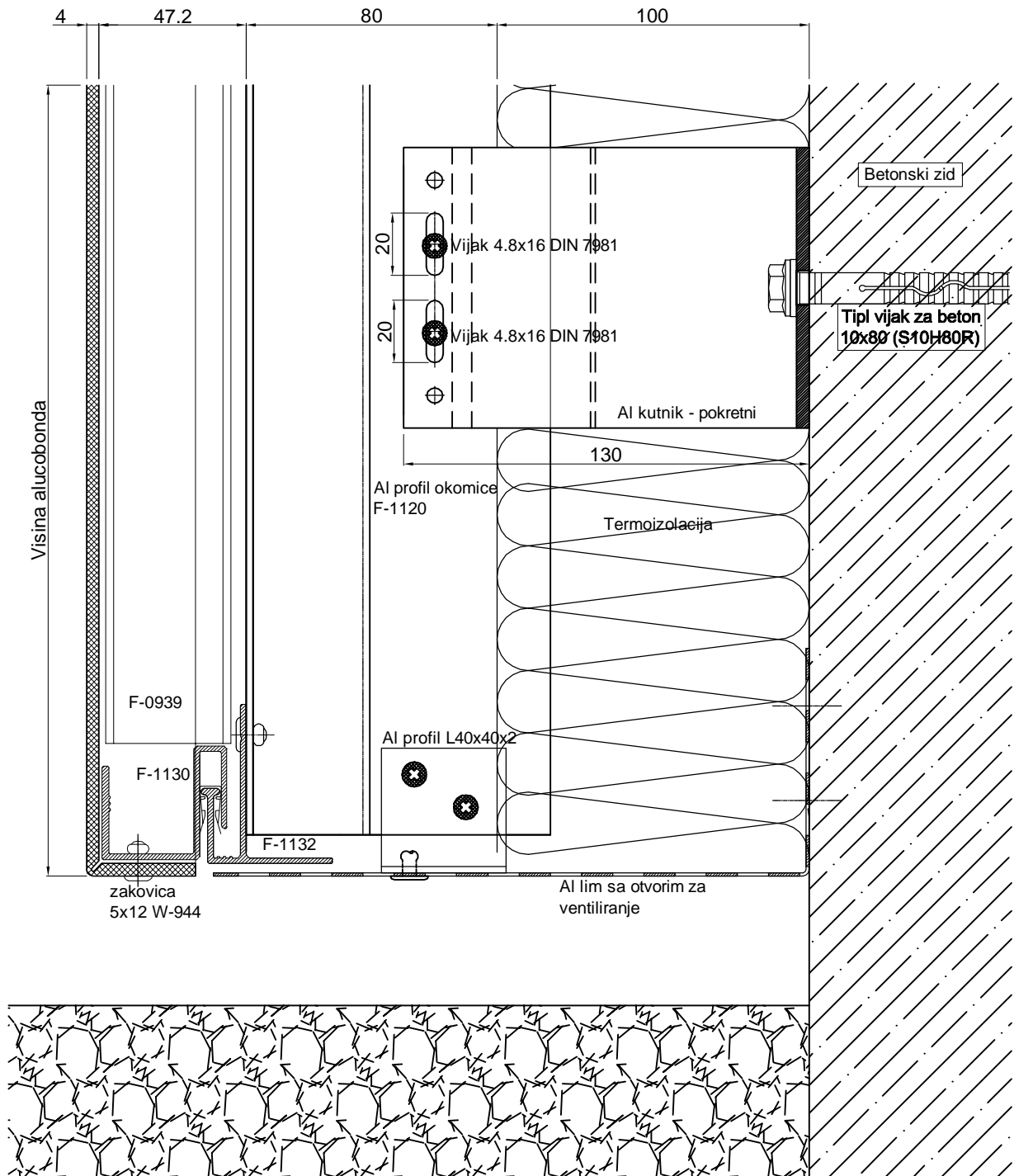

①

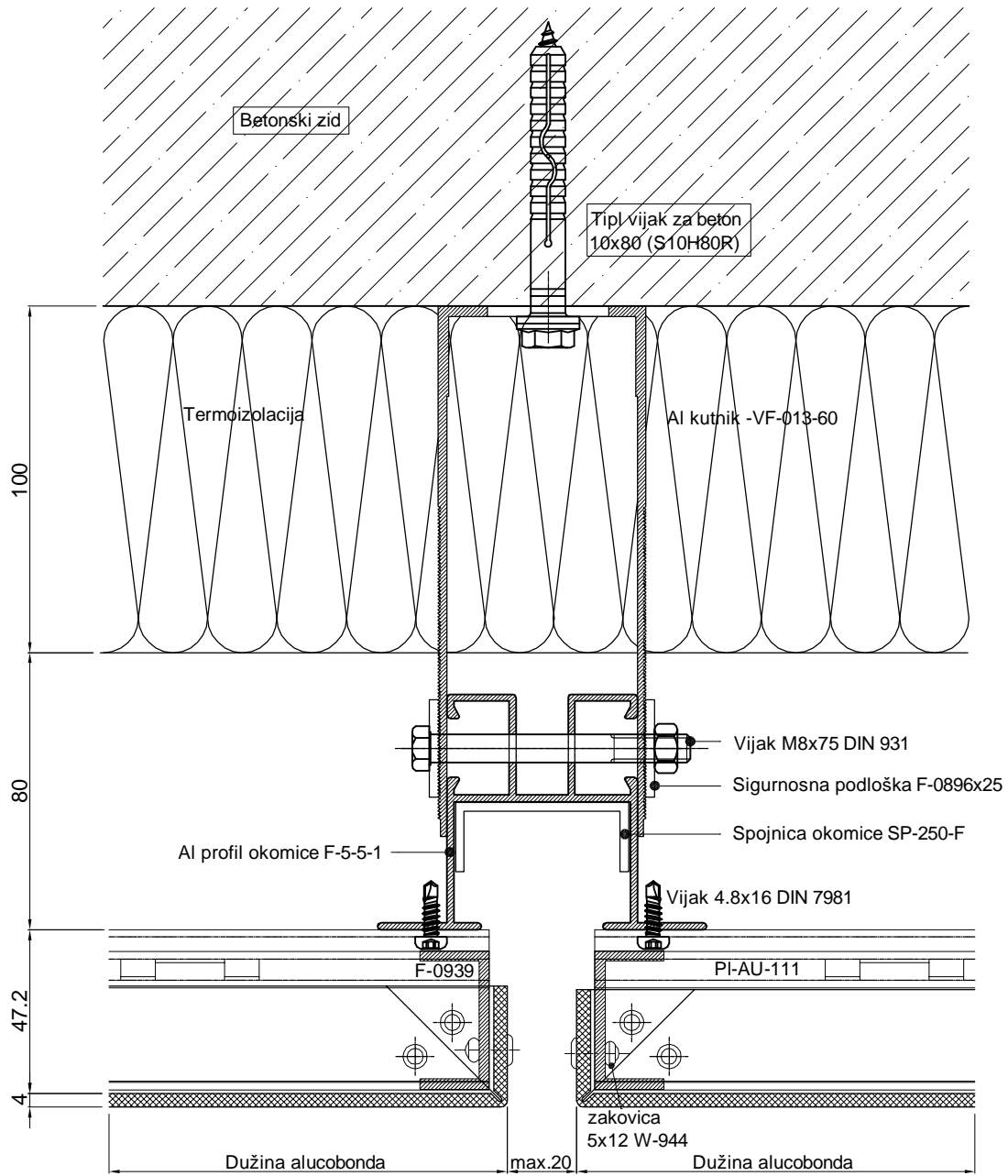

②

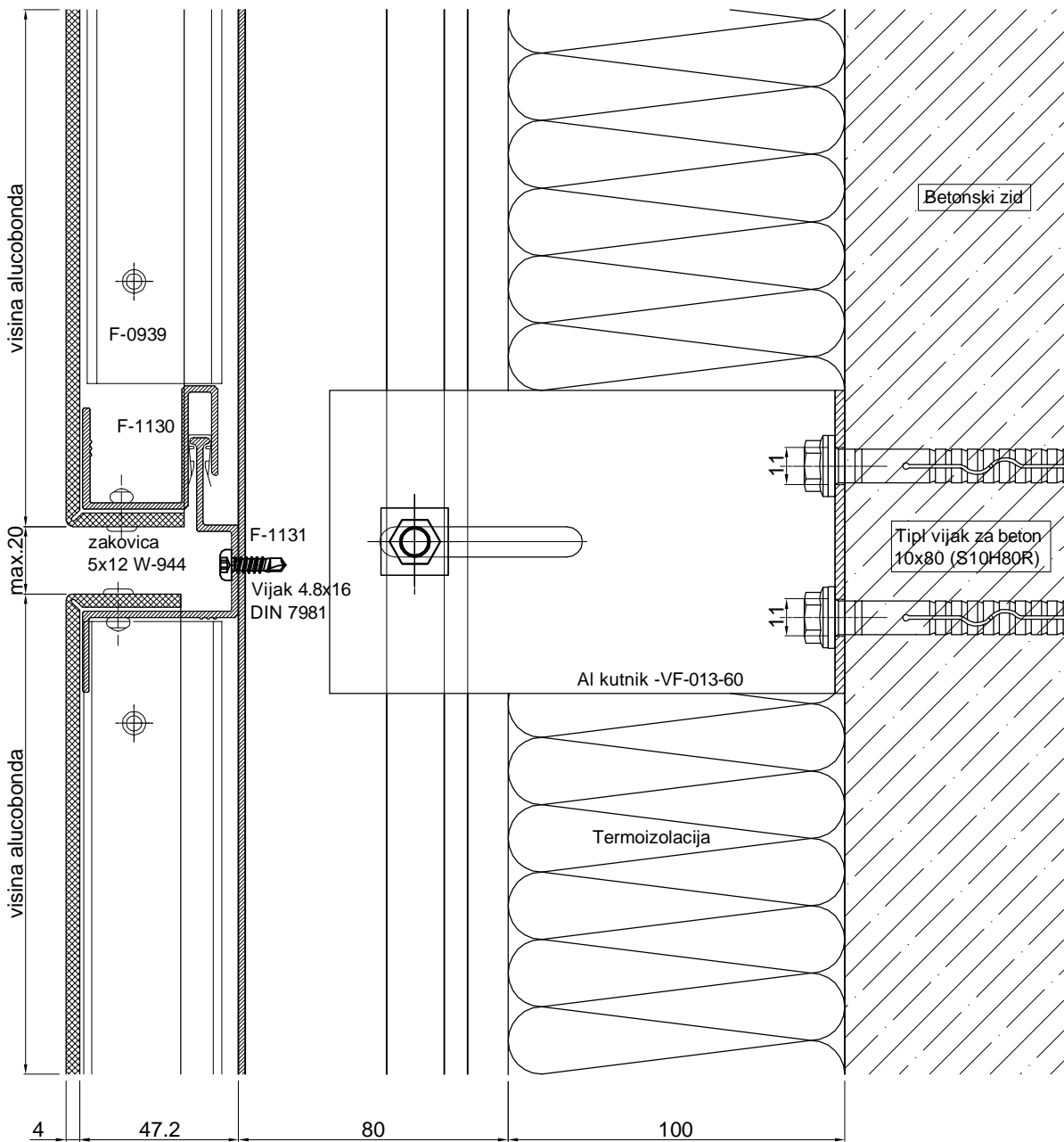

ALUCOBOND FASADA

-obrade i montaža-

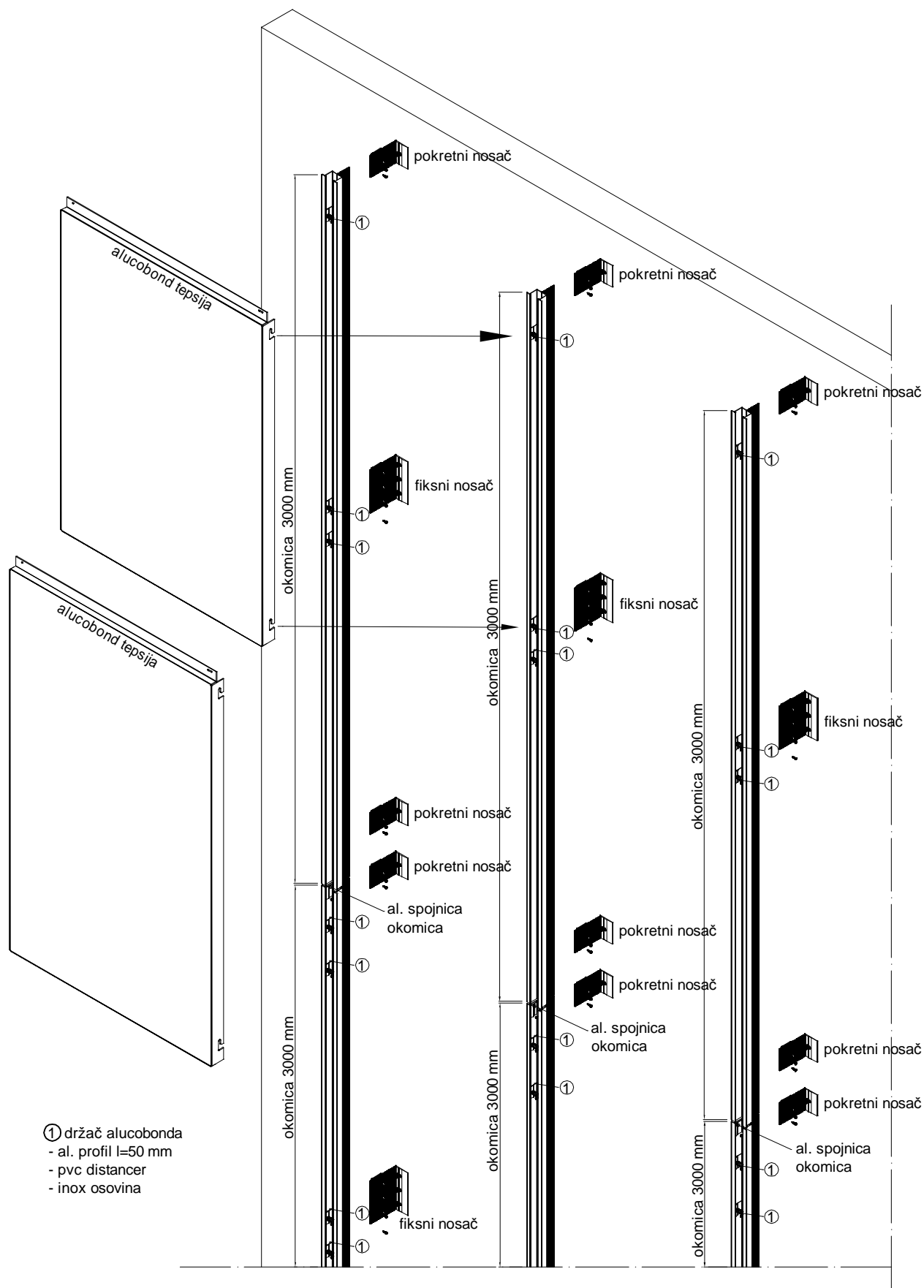

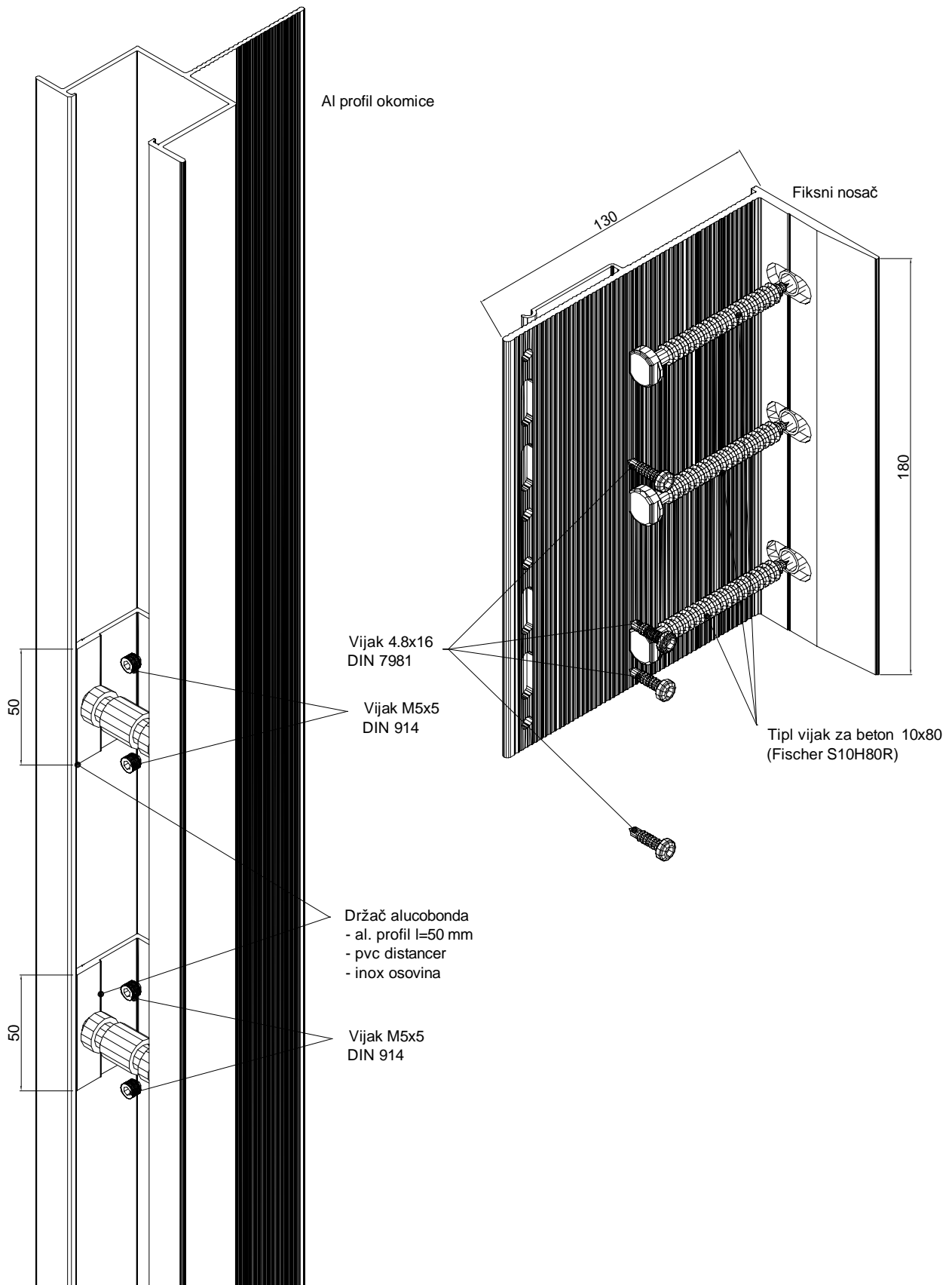

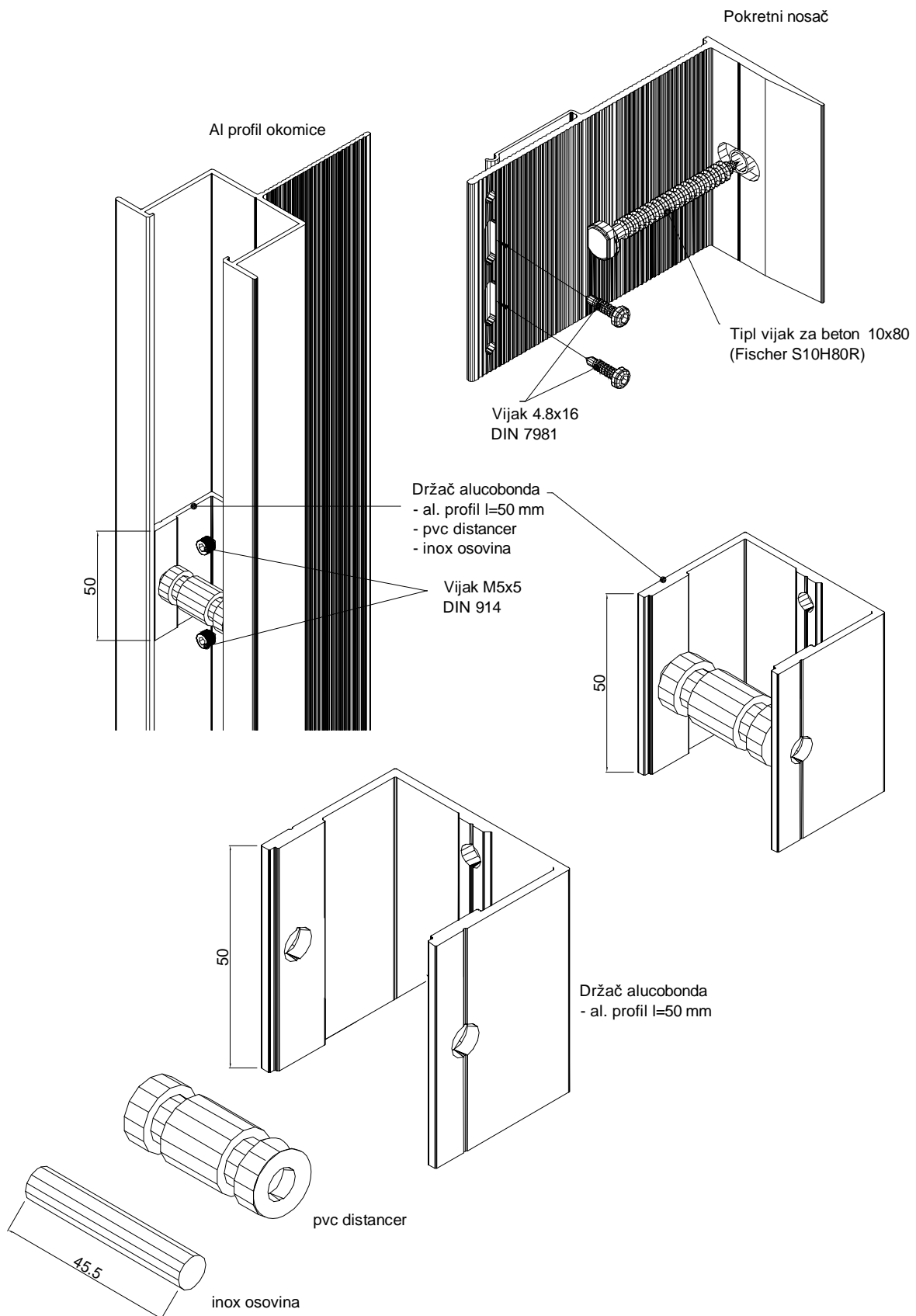

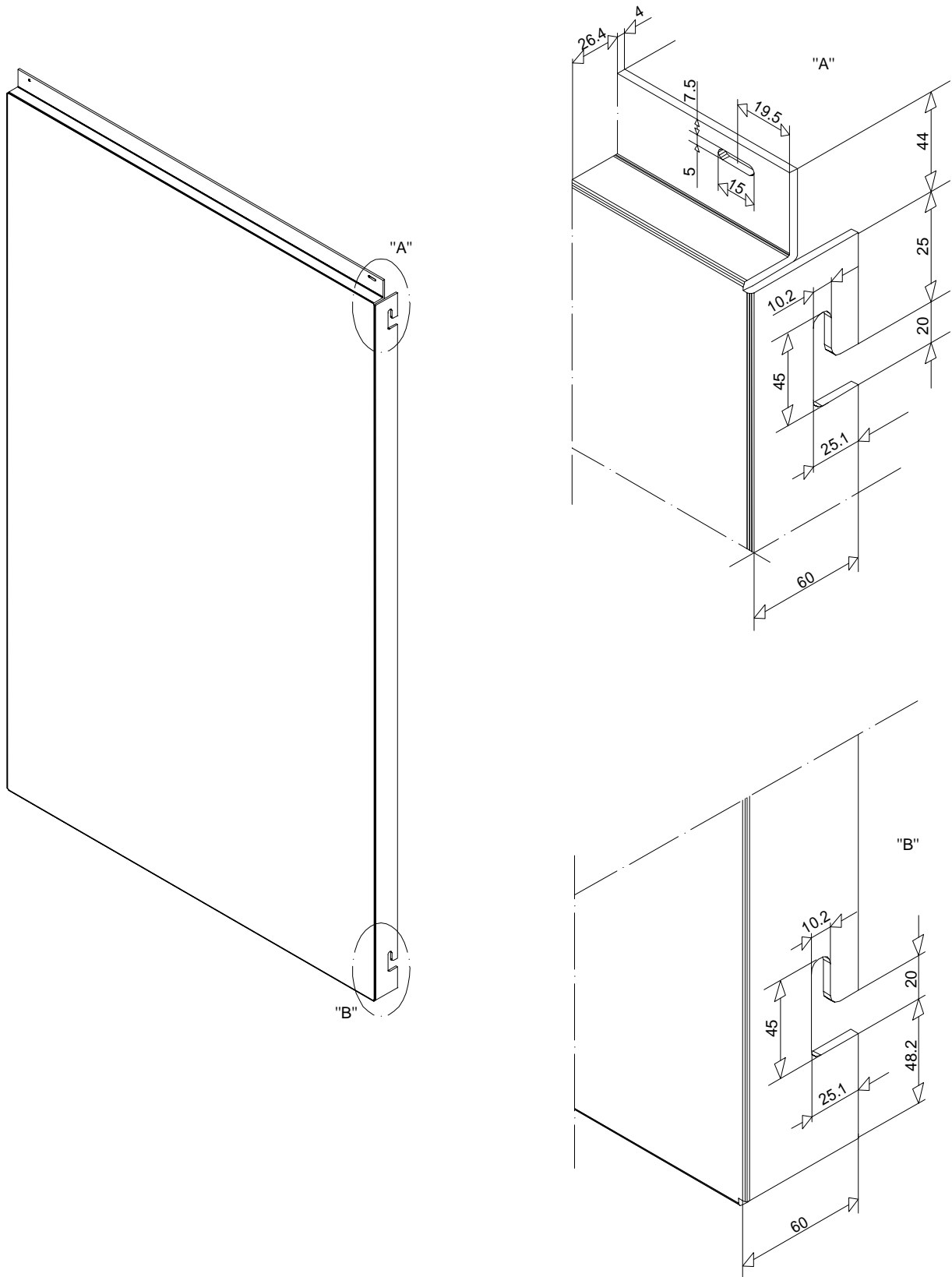

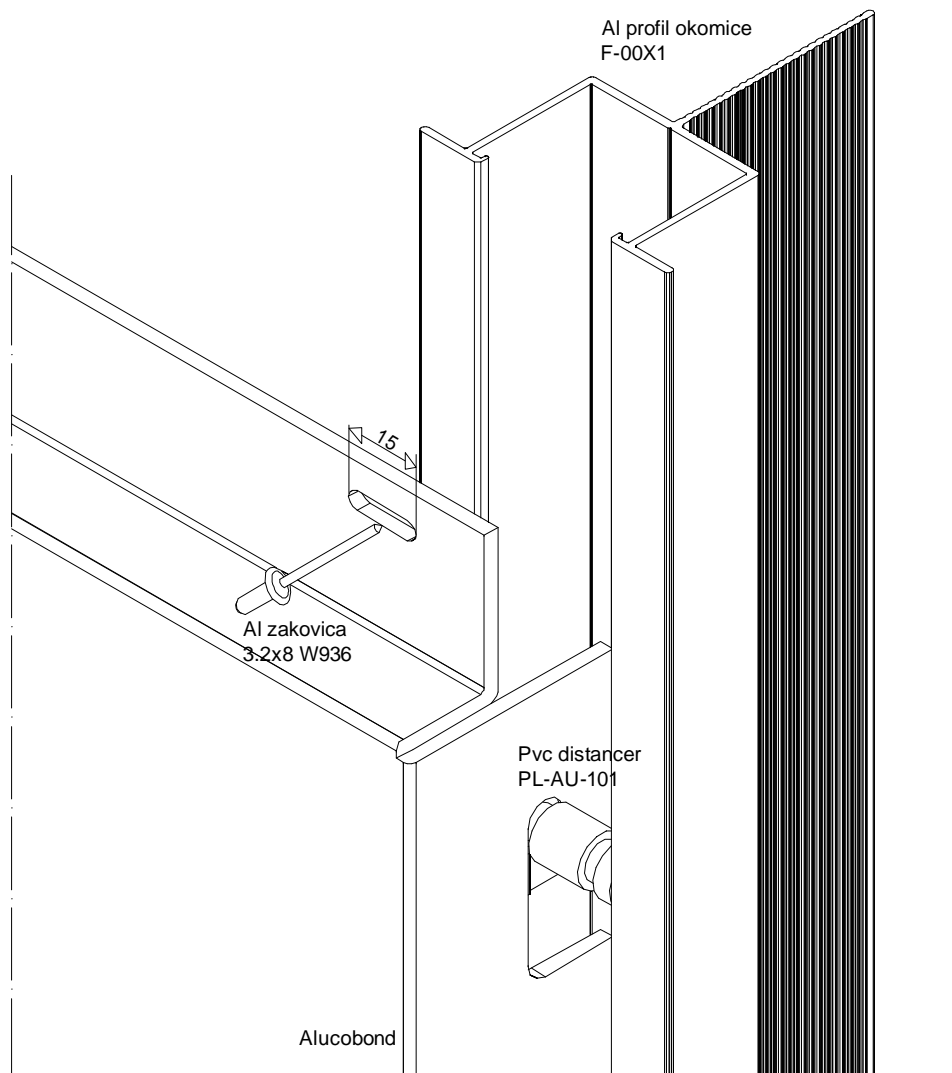

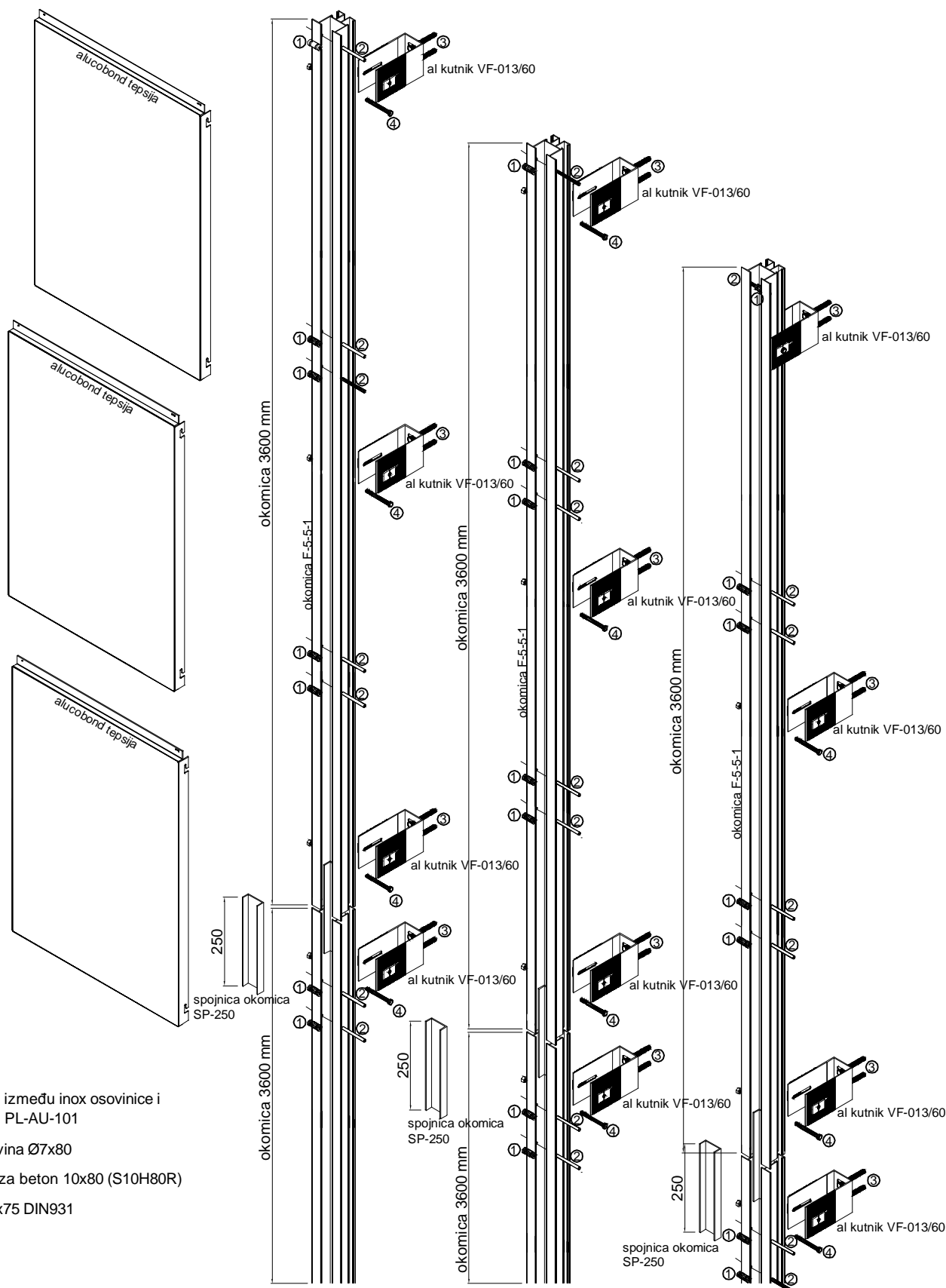

- ① distancer između inox osovine i alucobonda PL-AU-101
- ② inox osovina Ø7x80
- ③ tipl vijak za beton 10x80 (S10H80R)
- ④ vijak M8x75 DIN931

-spoj dvije okomice-

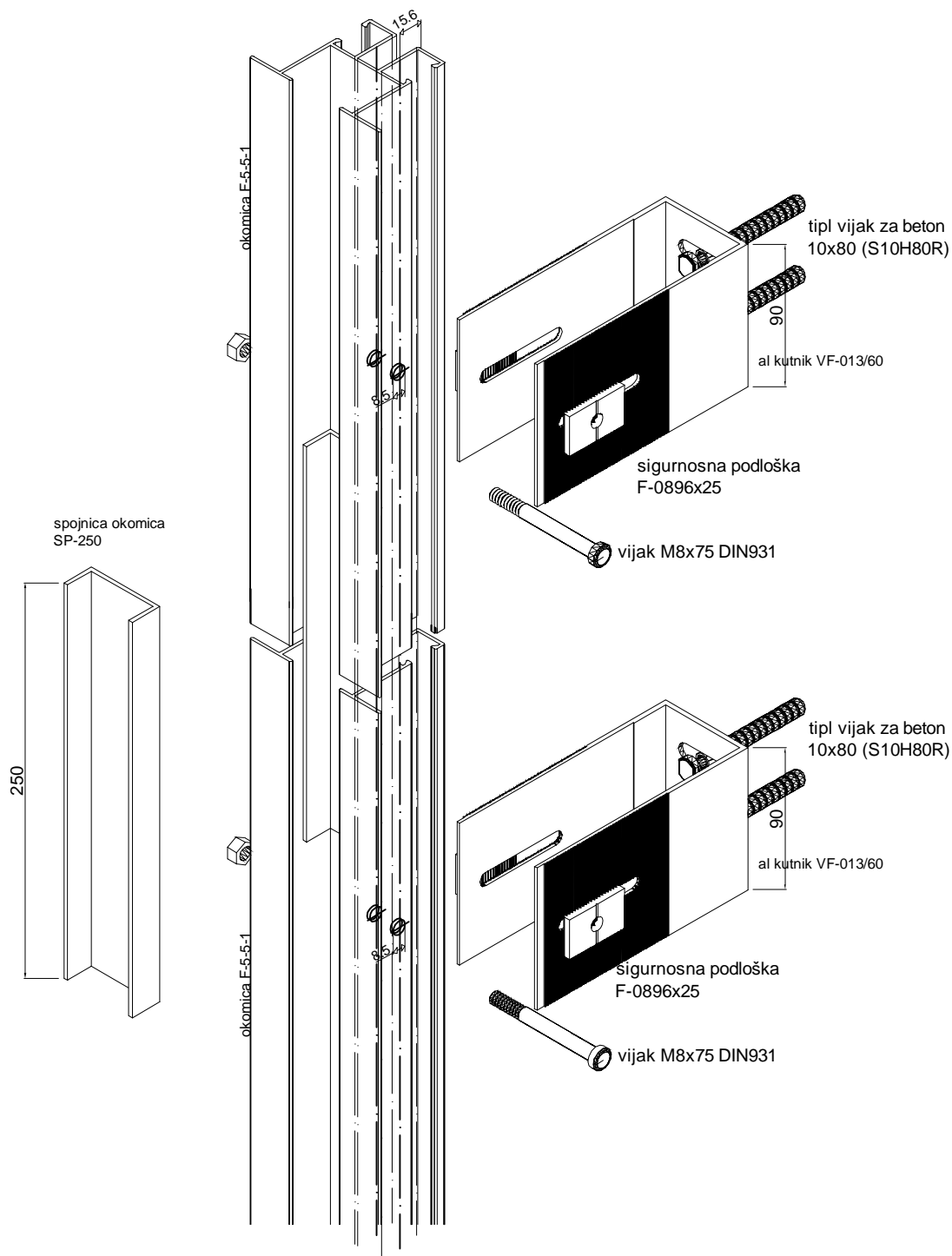

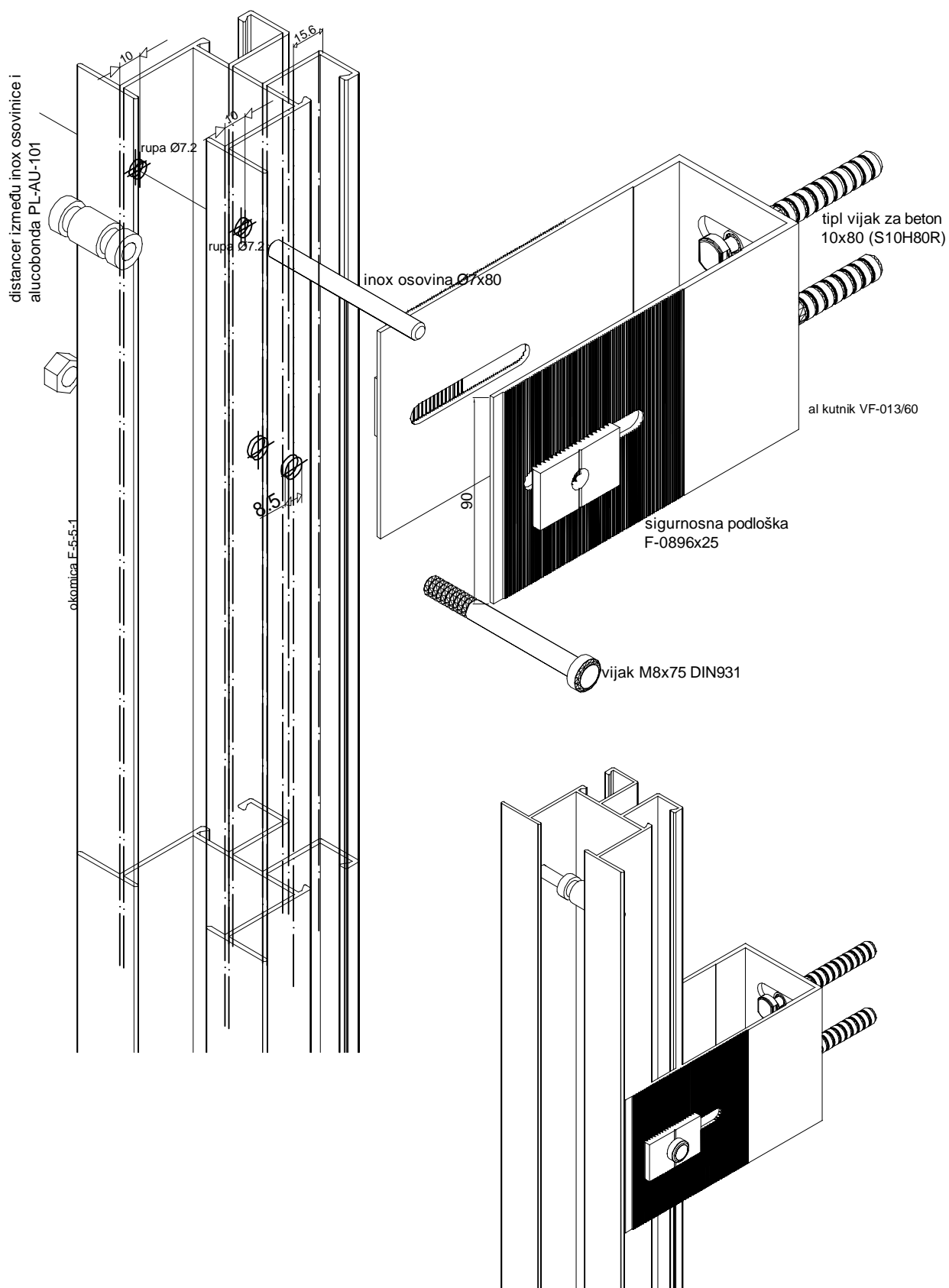

VENTILIRAJUĆE
FASADNE OBLOGE

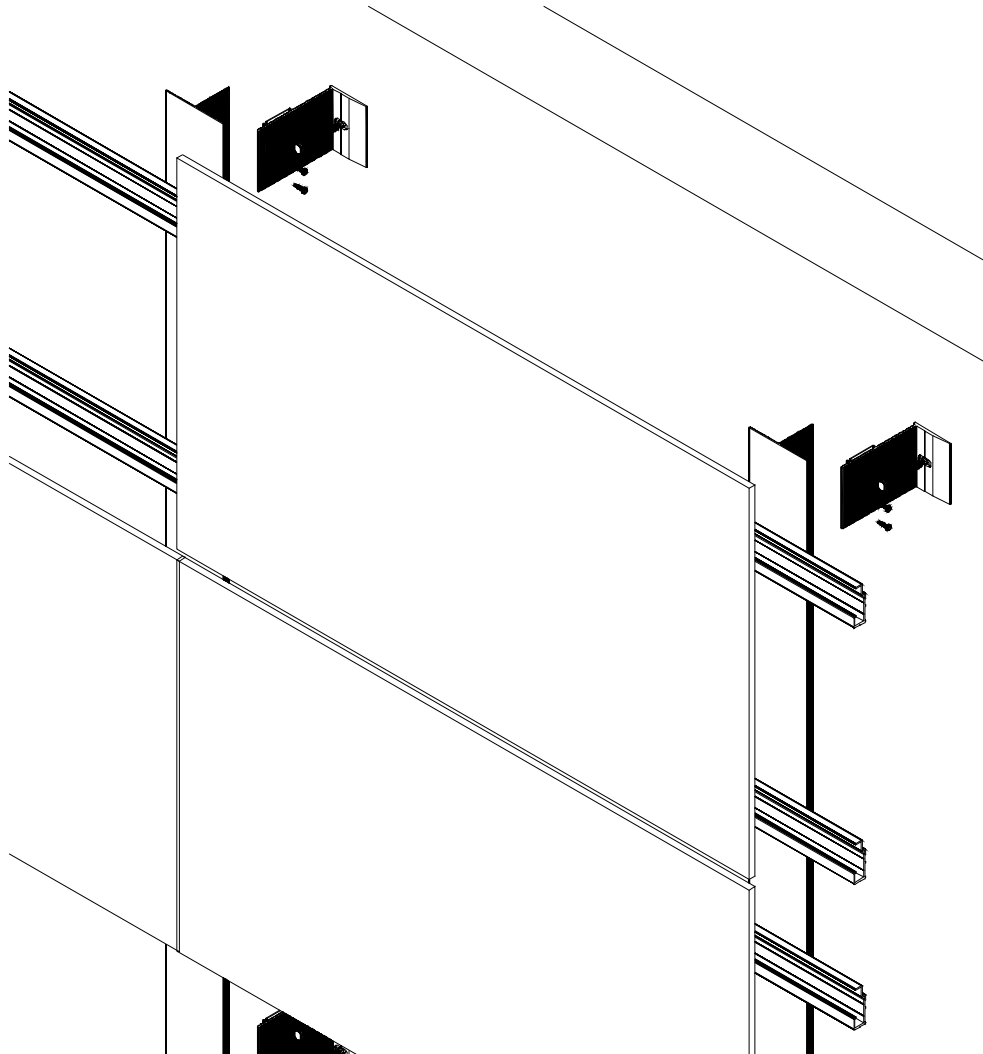

TRESPA

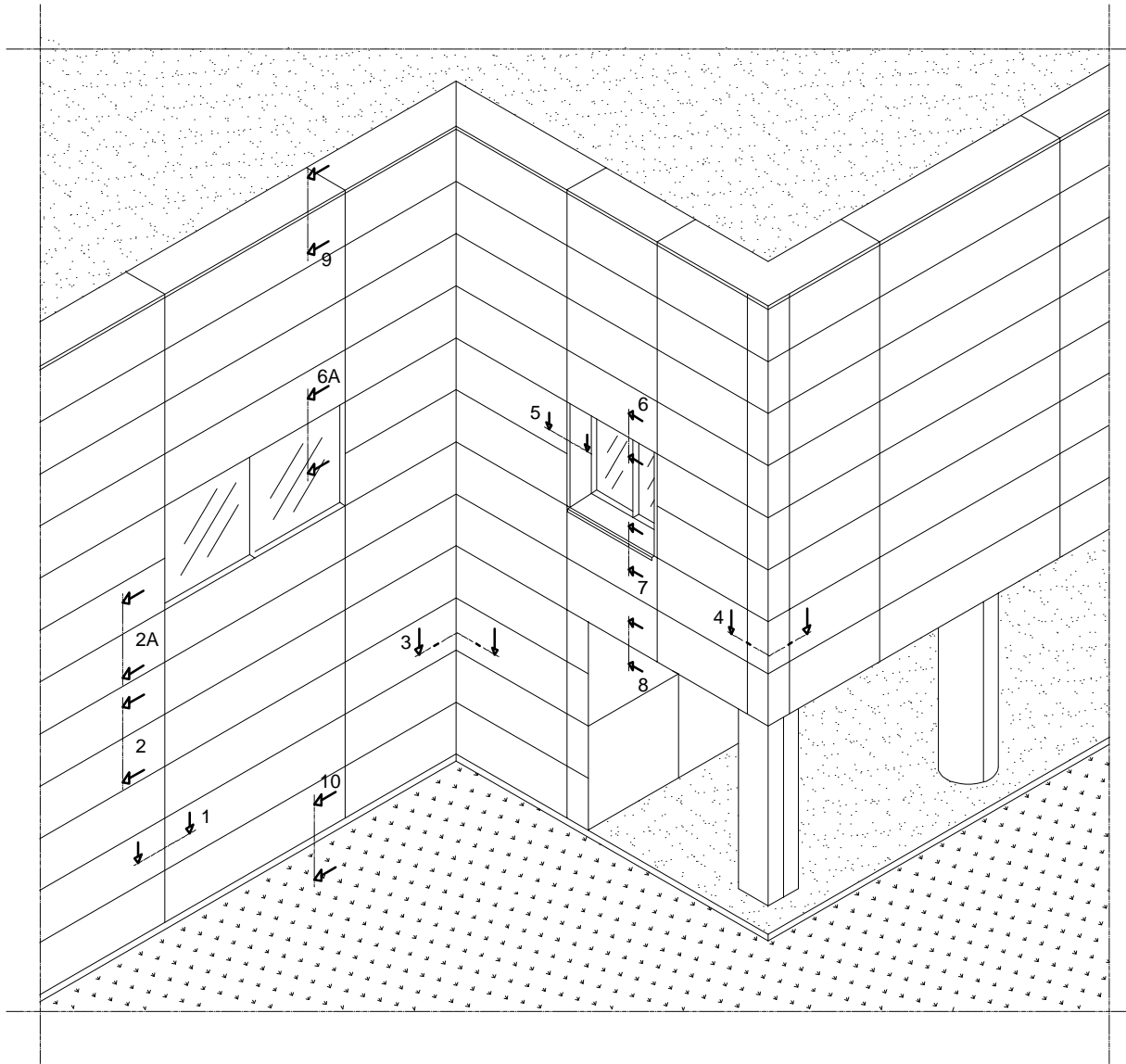

1

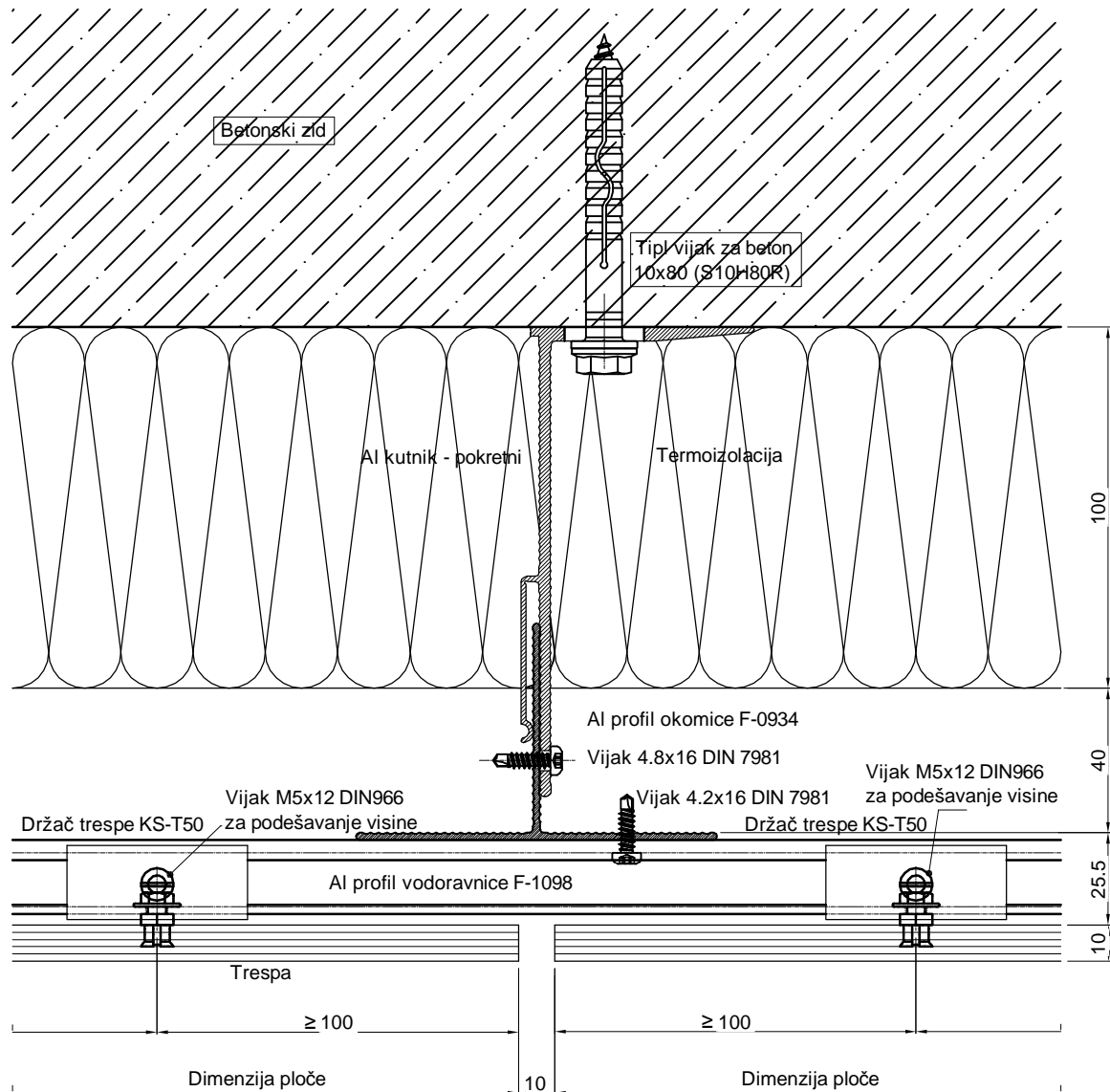

②

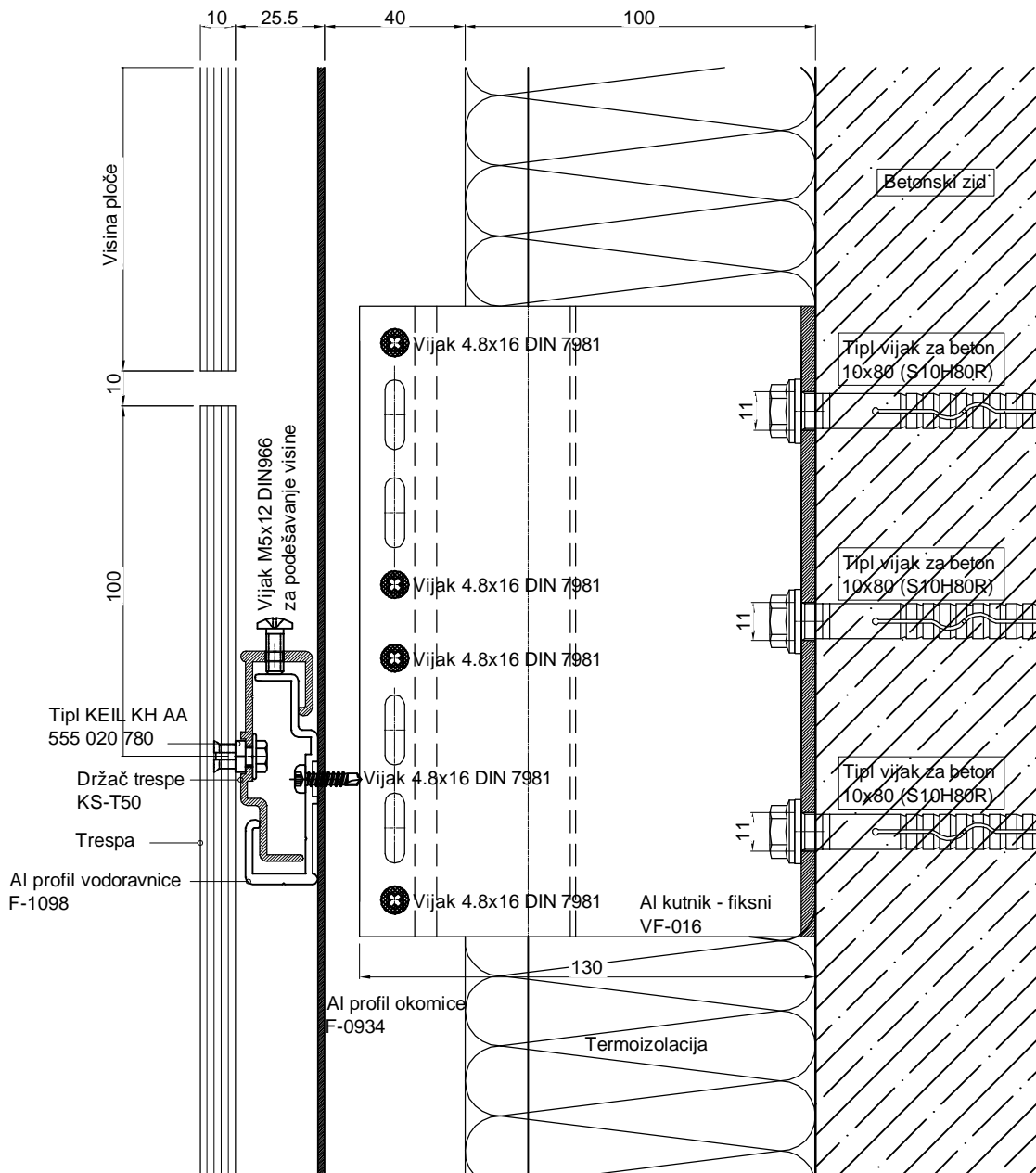

2A

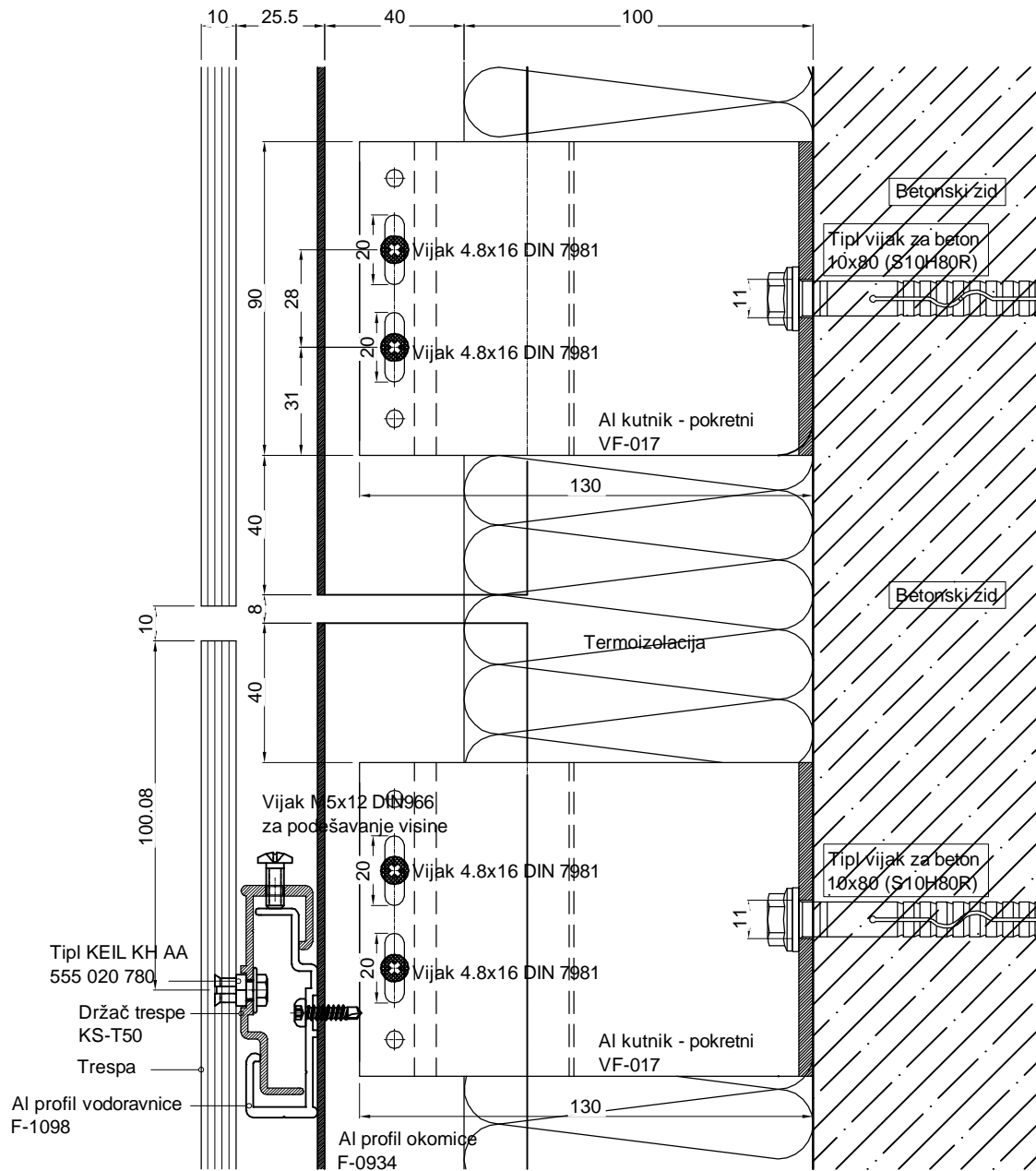

③

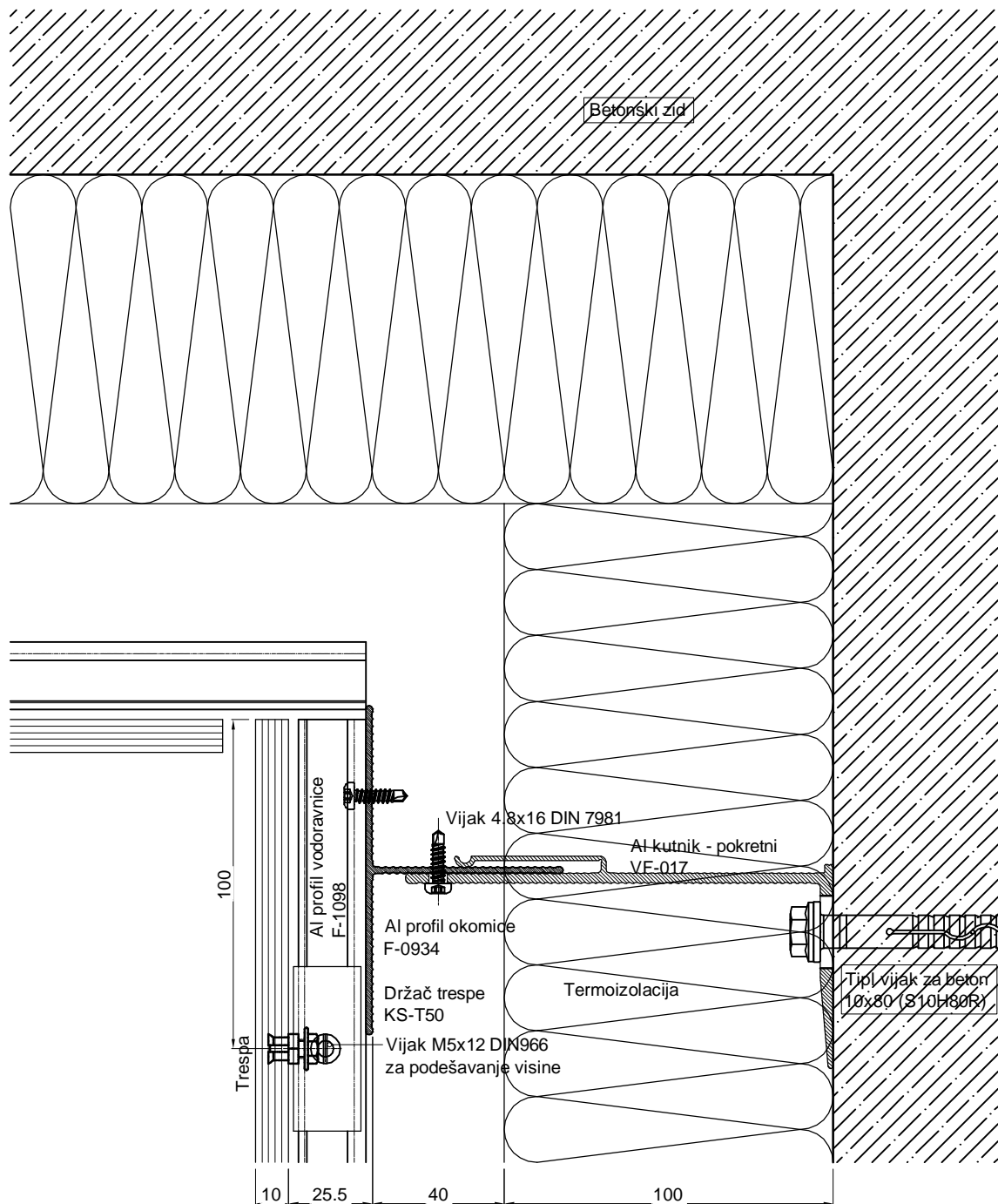

④

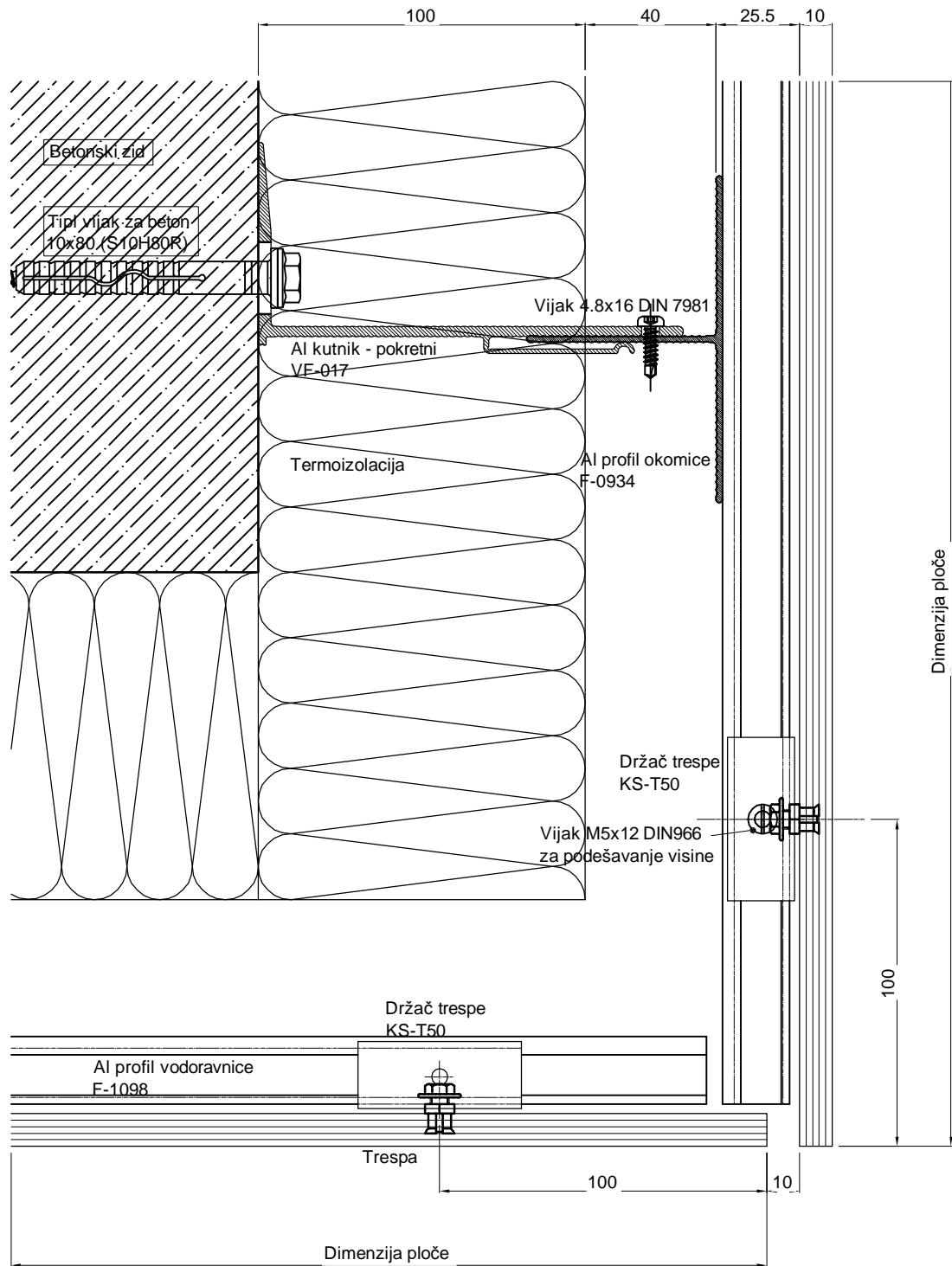

5

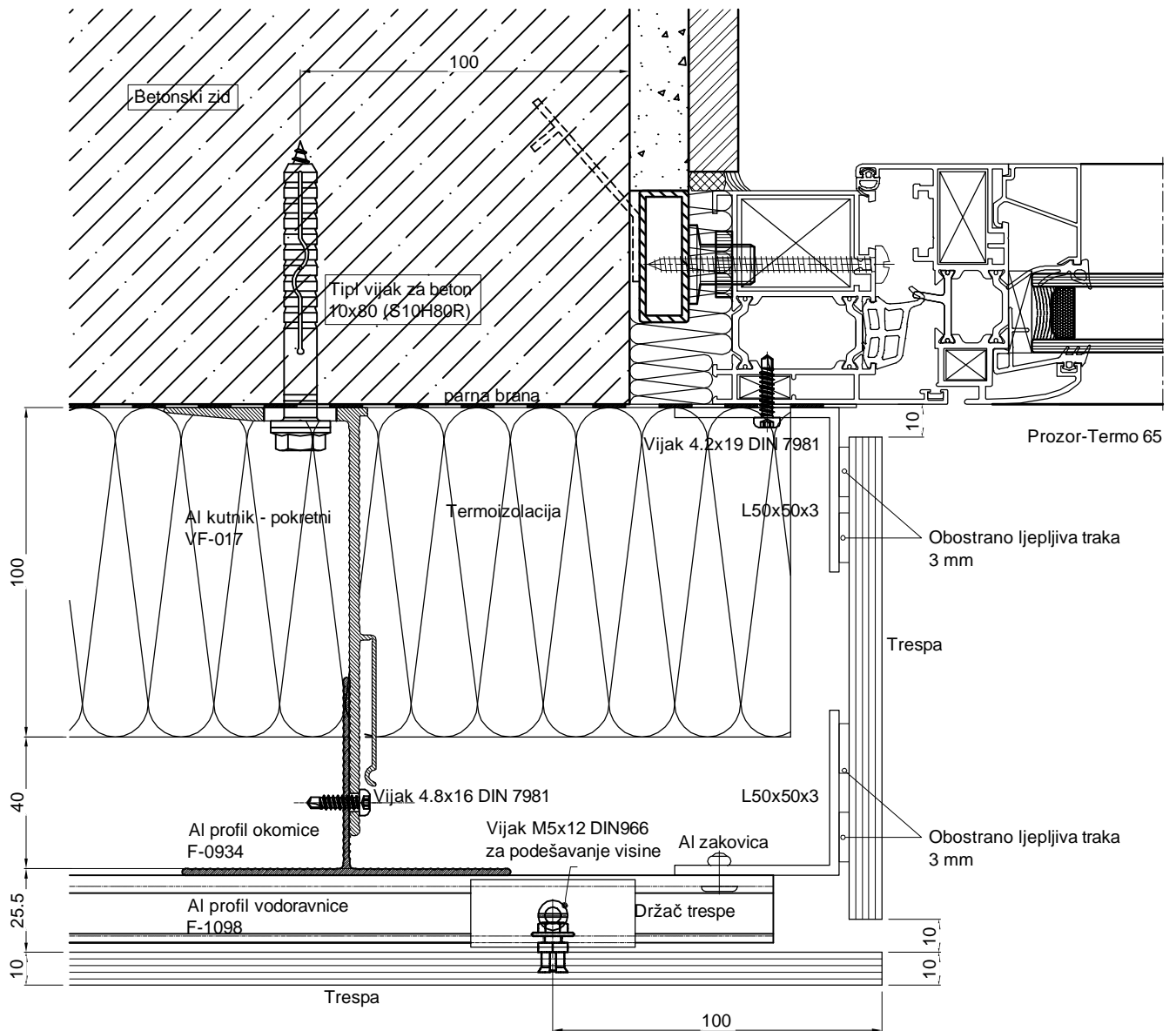

⑥

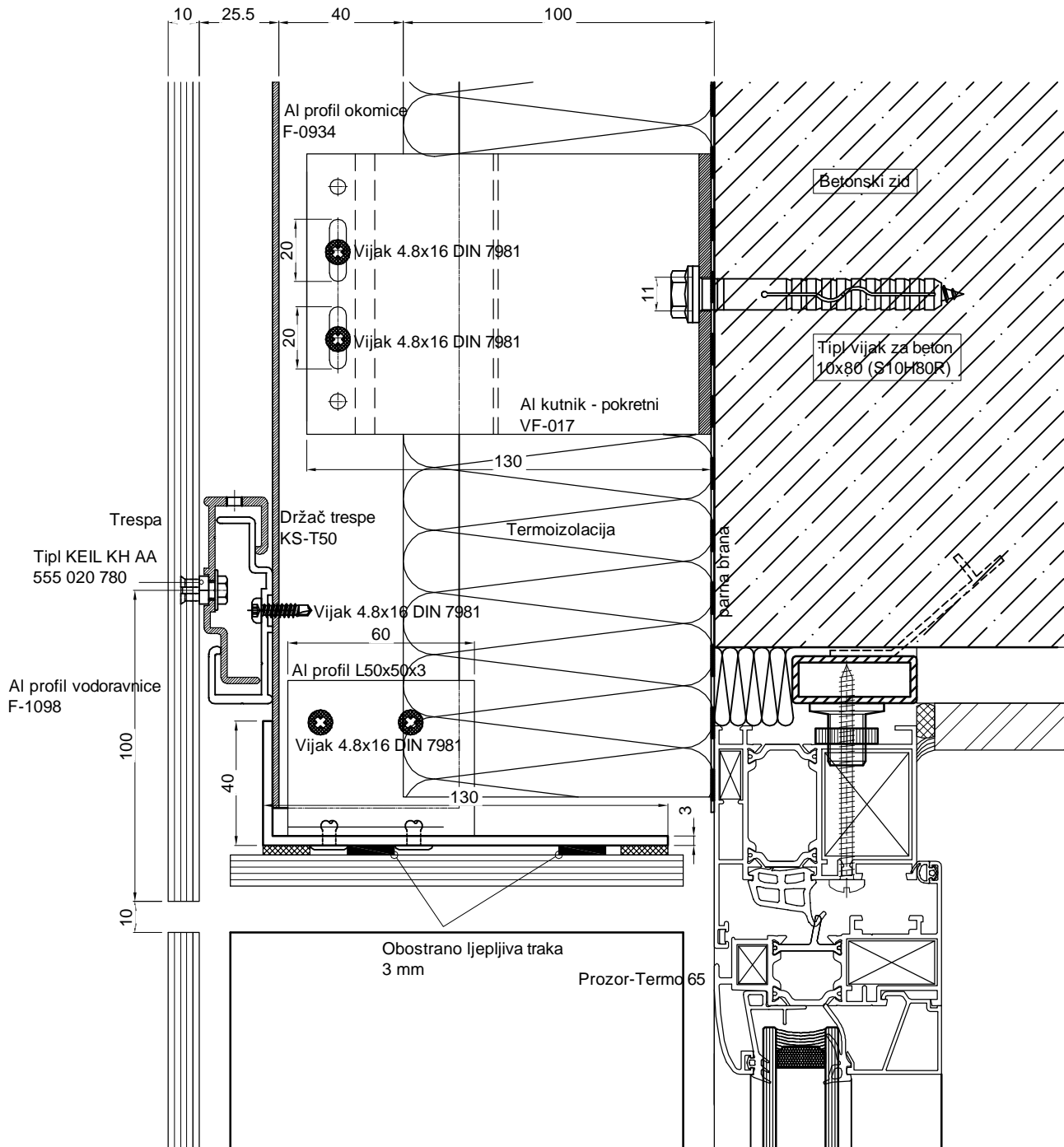

6A

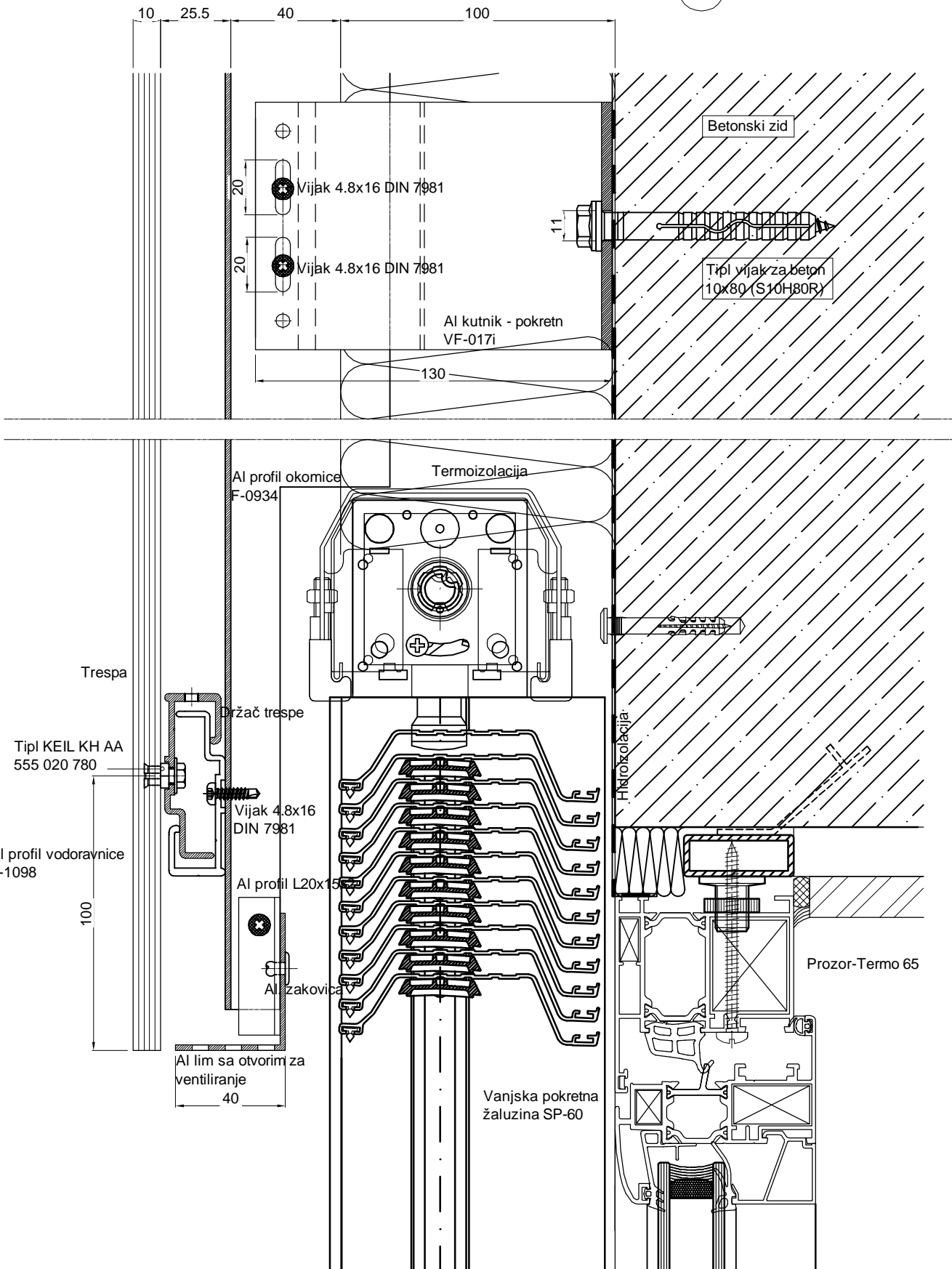

7

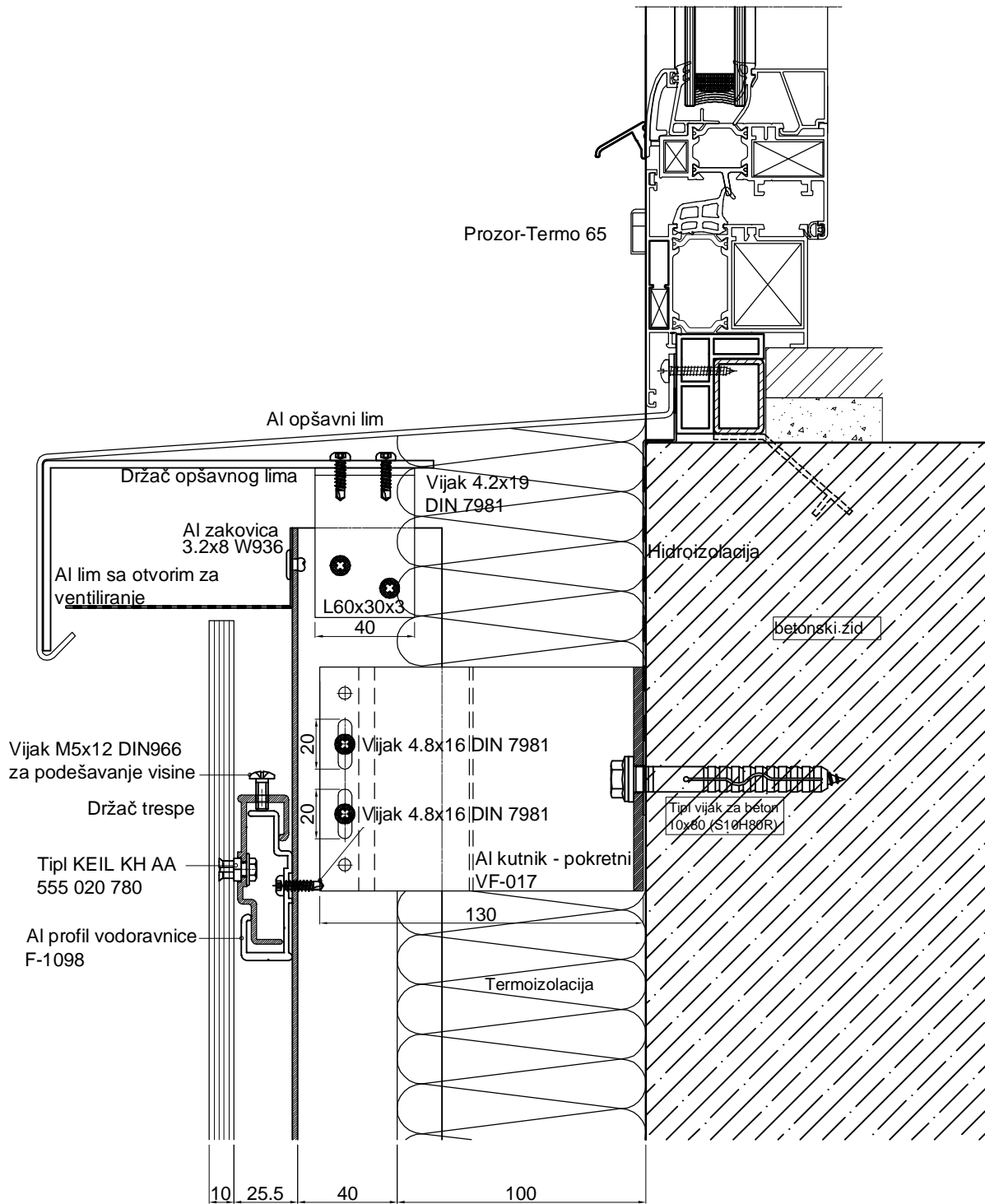

8

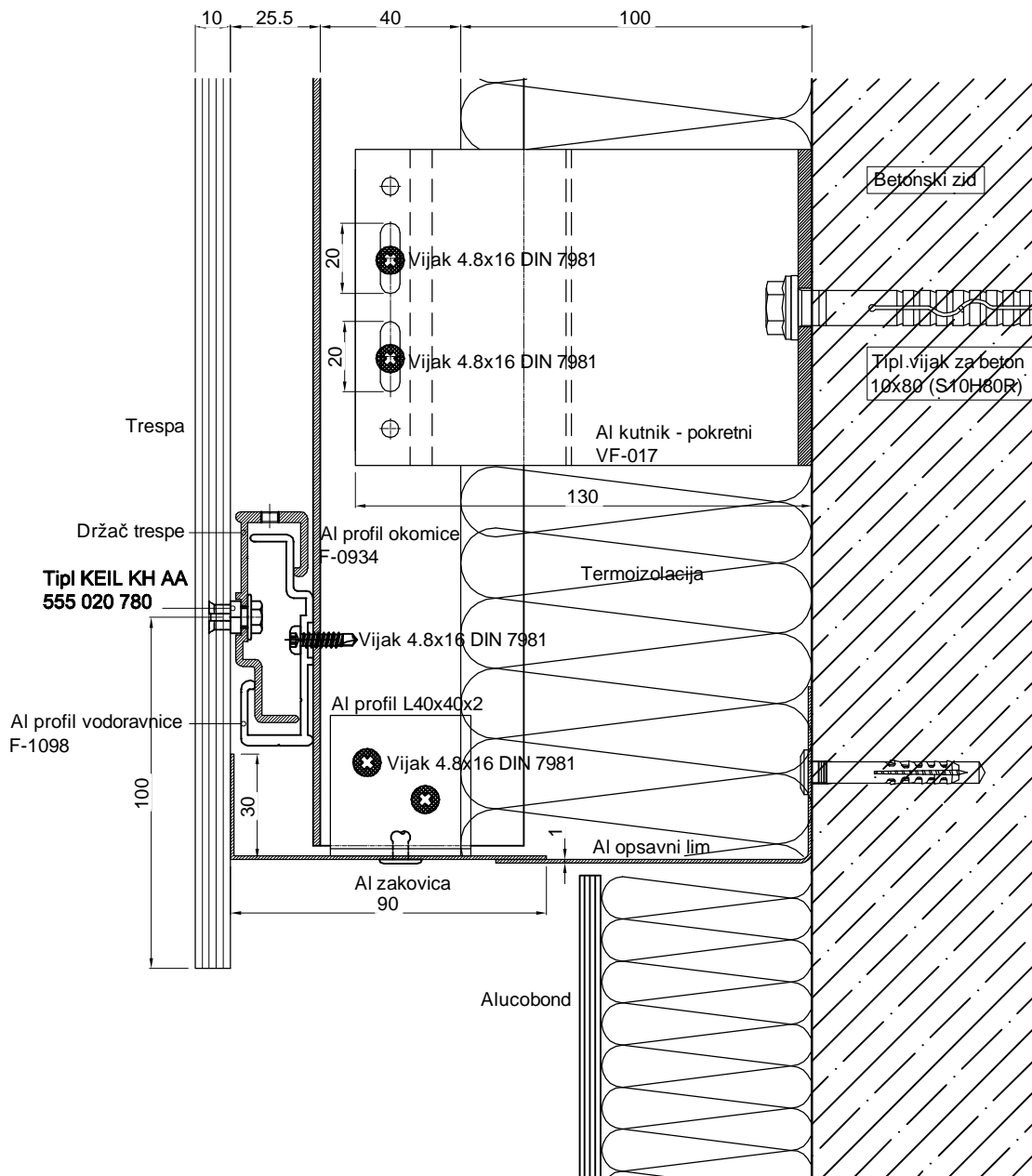

10

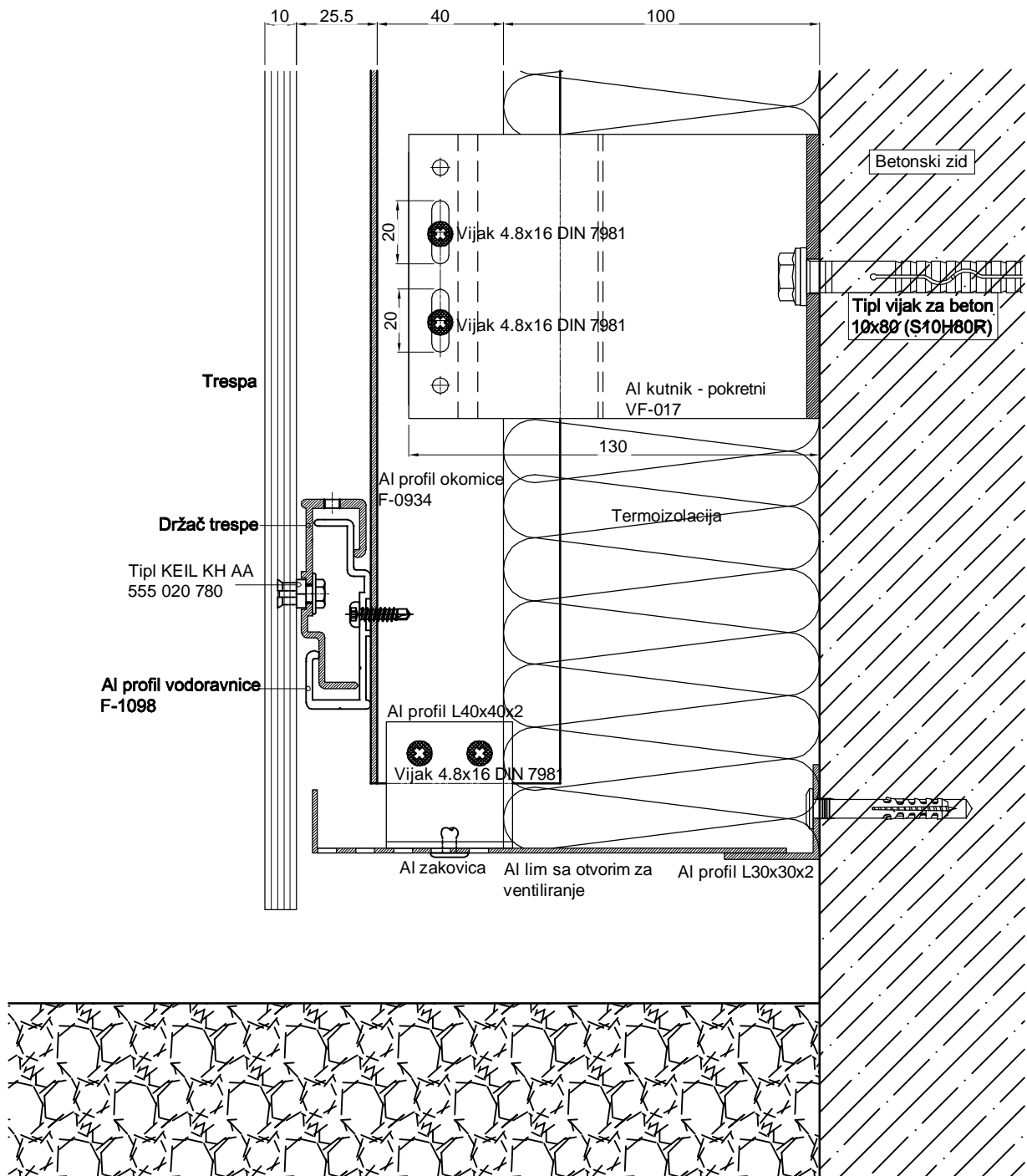

9

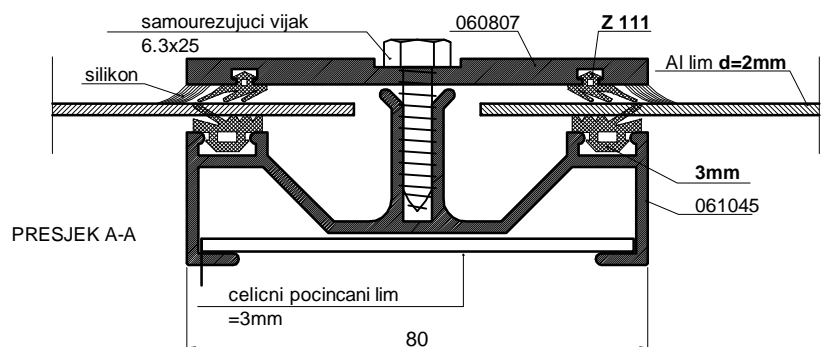
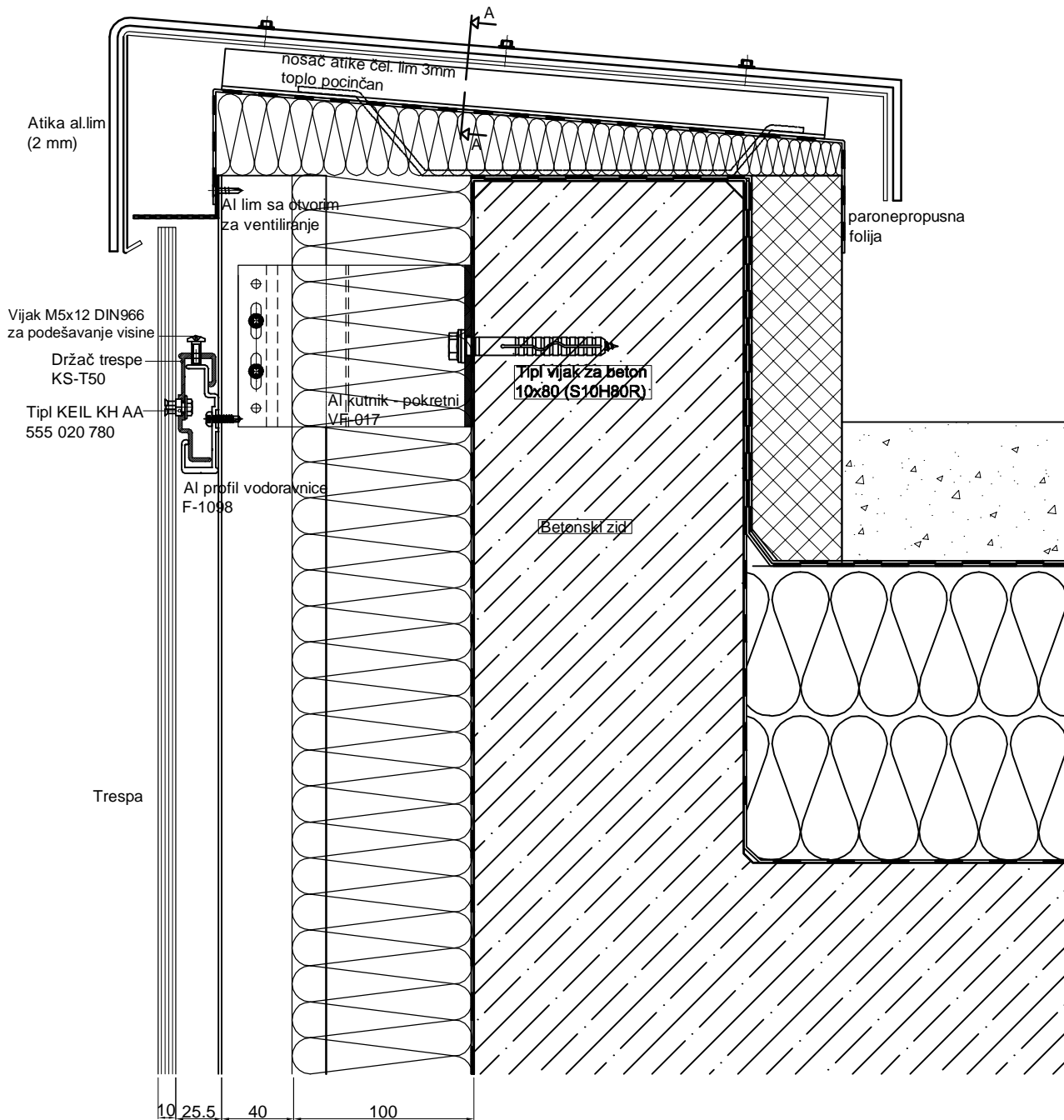

VENTILIRAJUĆE
FASADNE OBLOGE

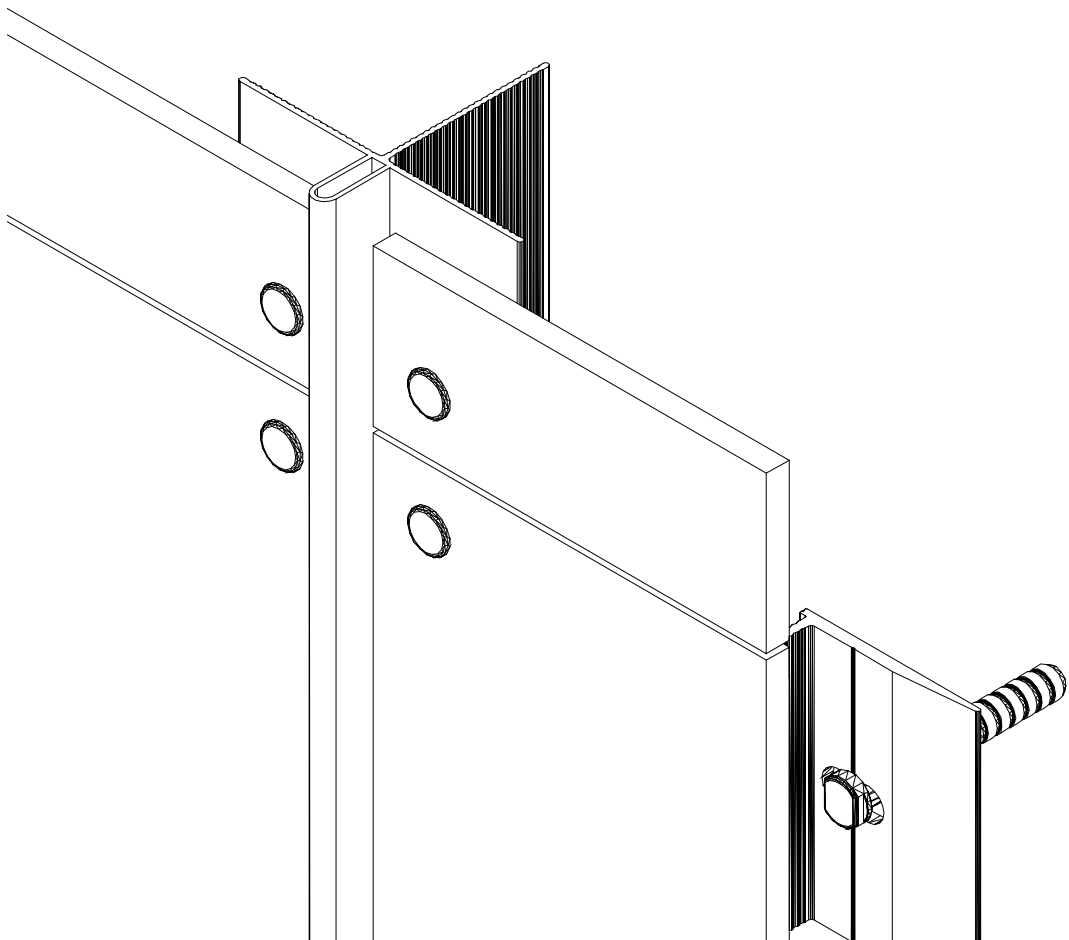

TRESPA - TIP T1

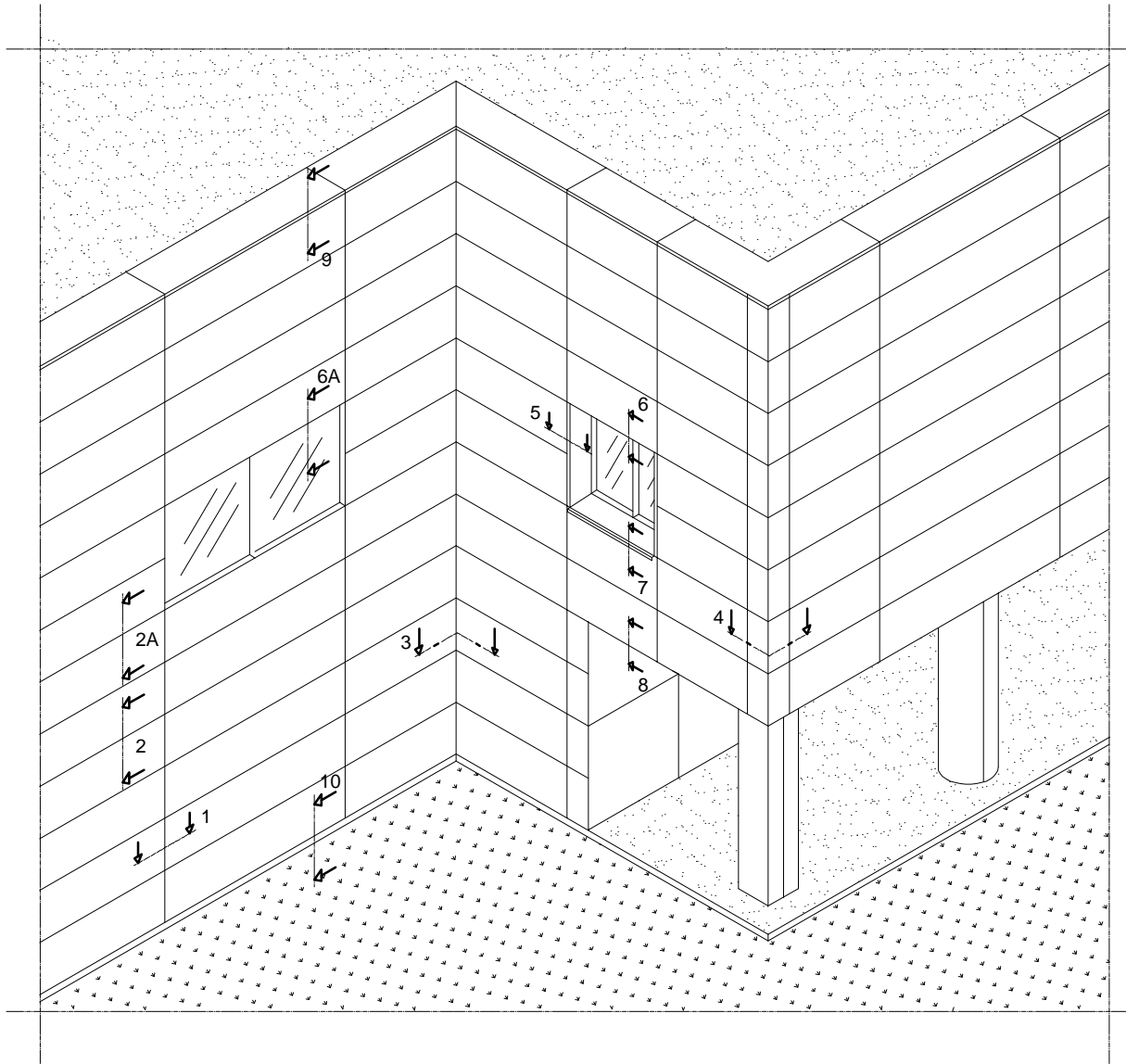

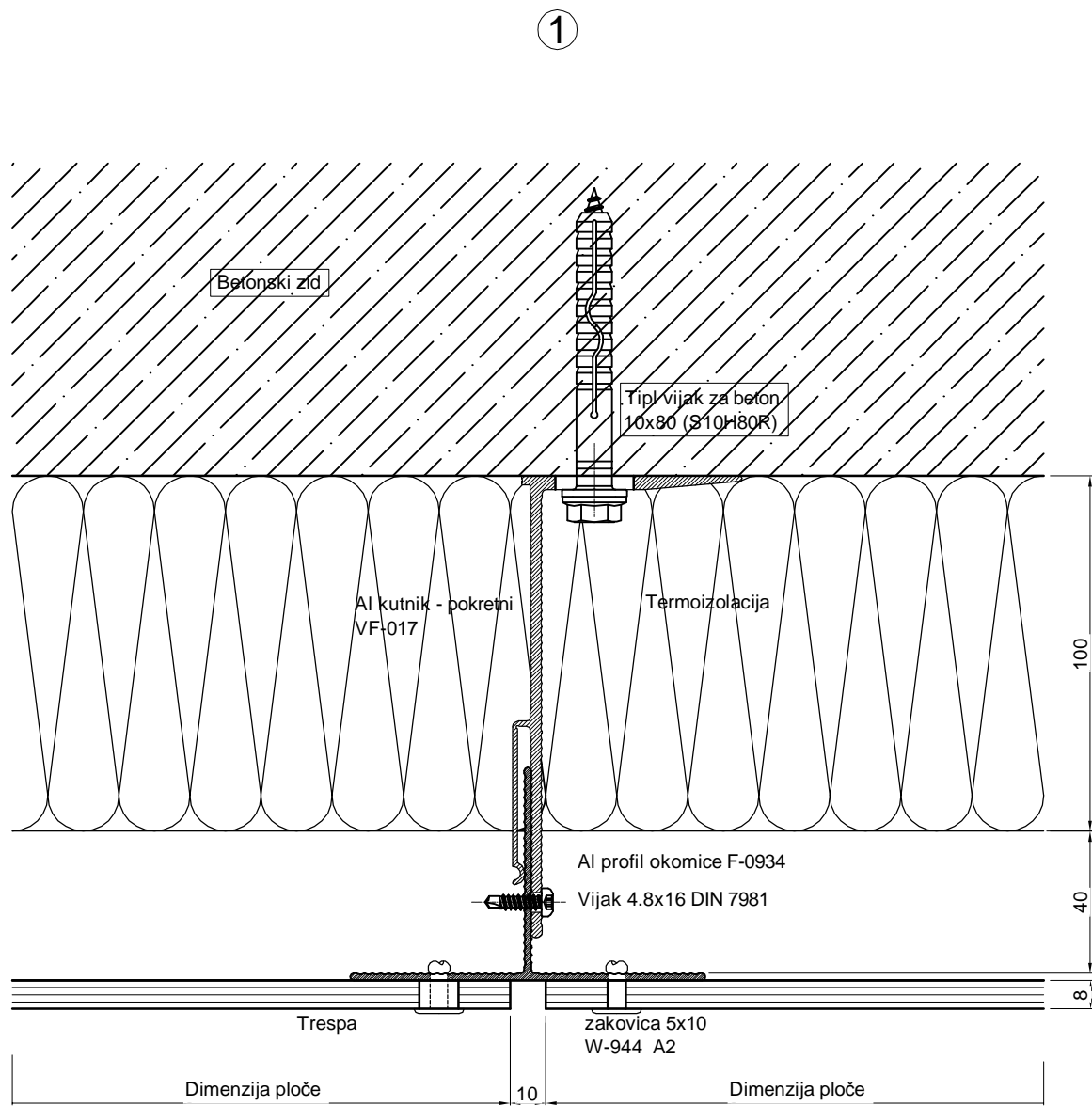

②

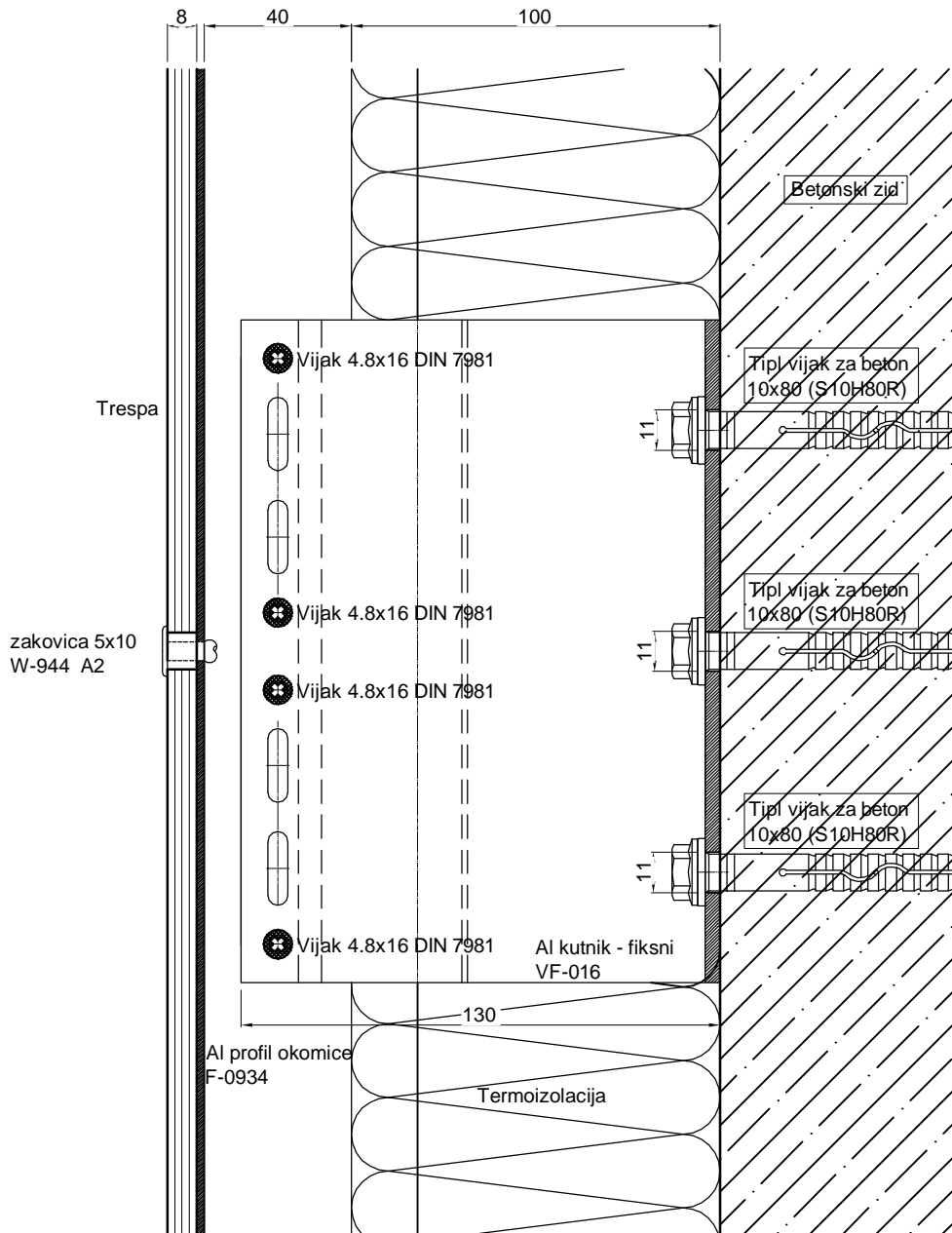

2A

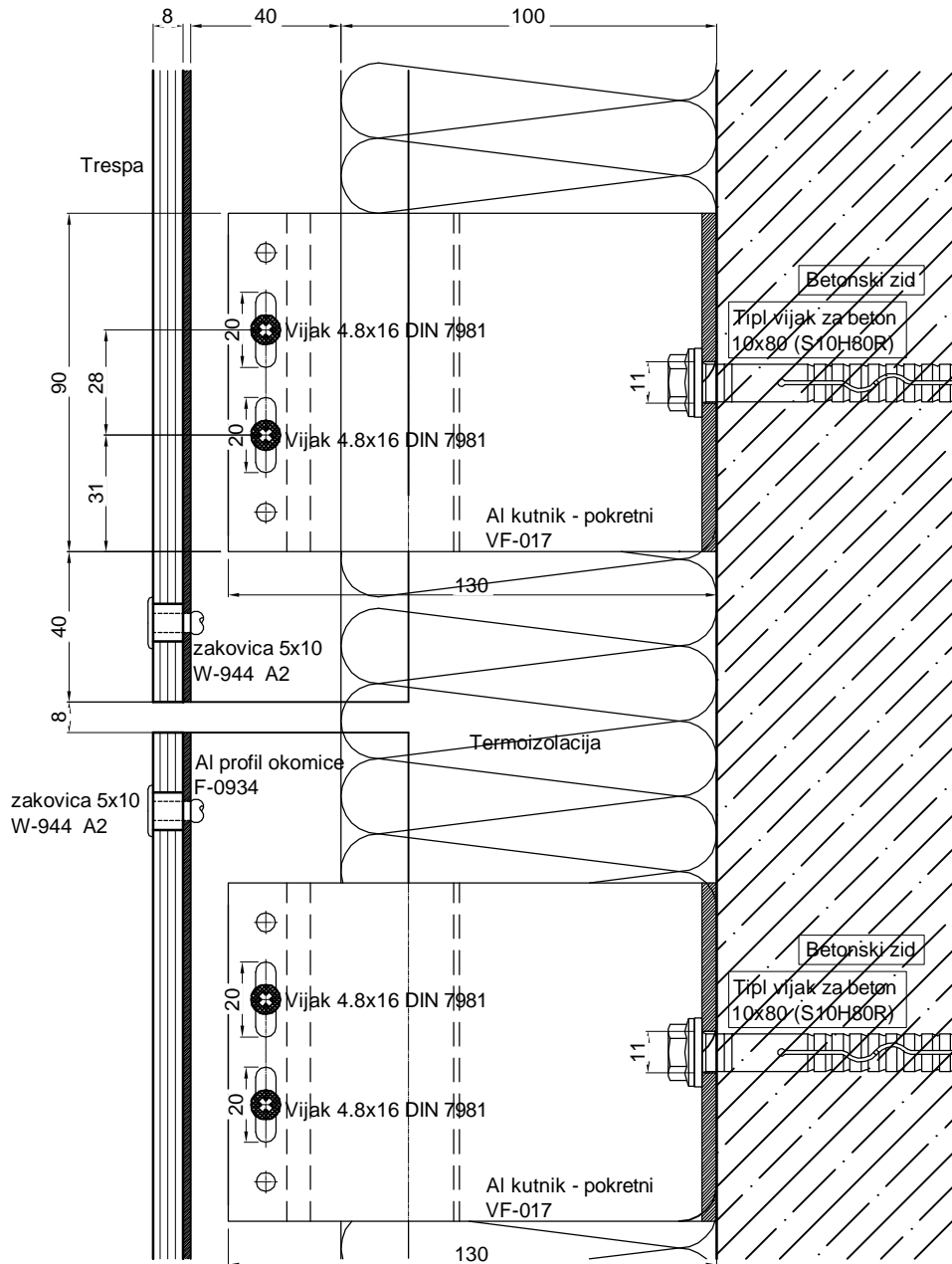

③

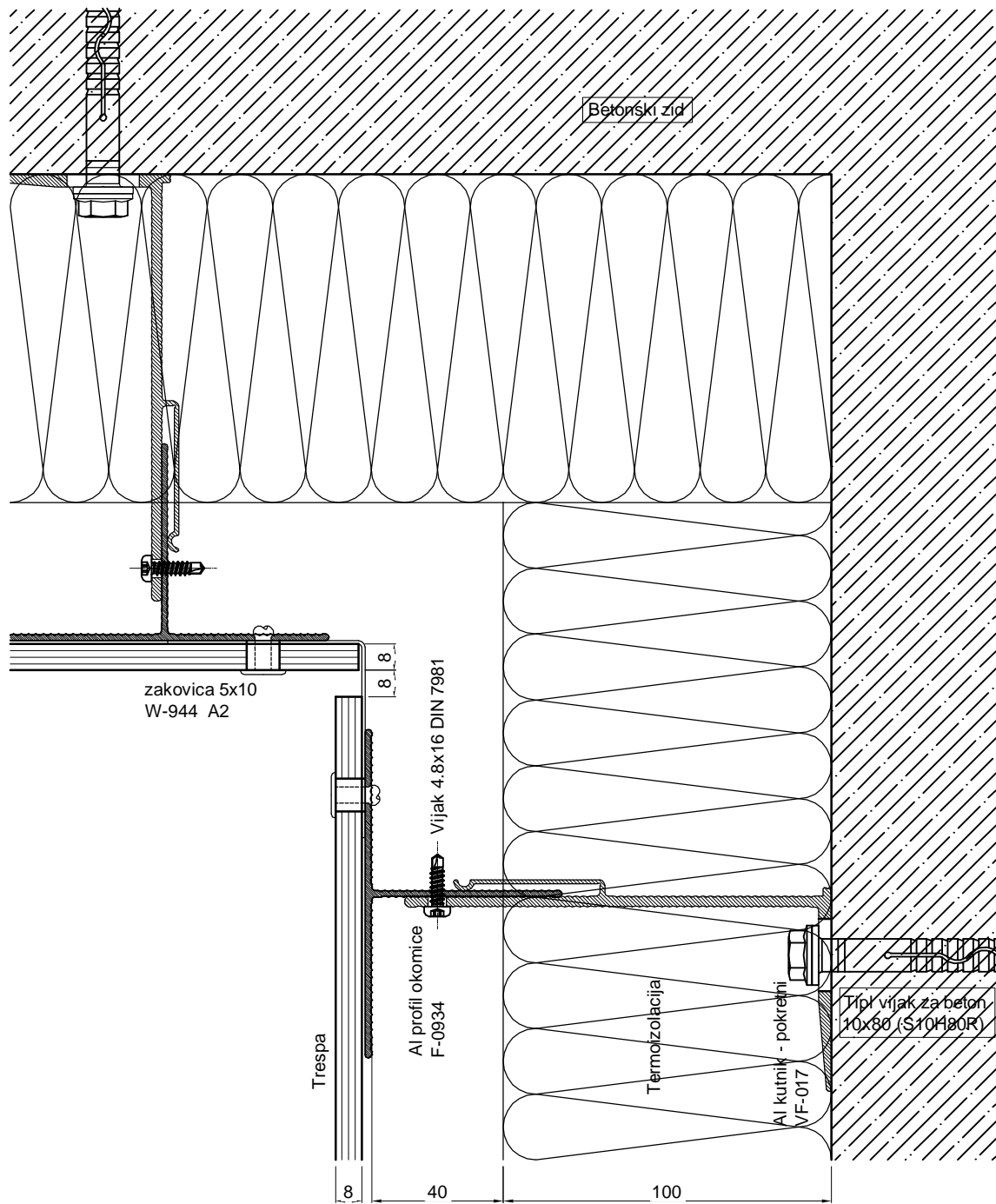

④

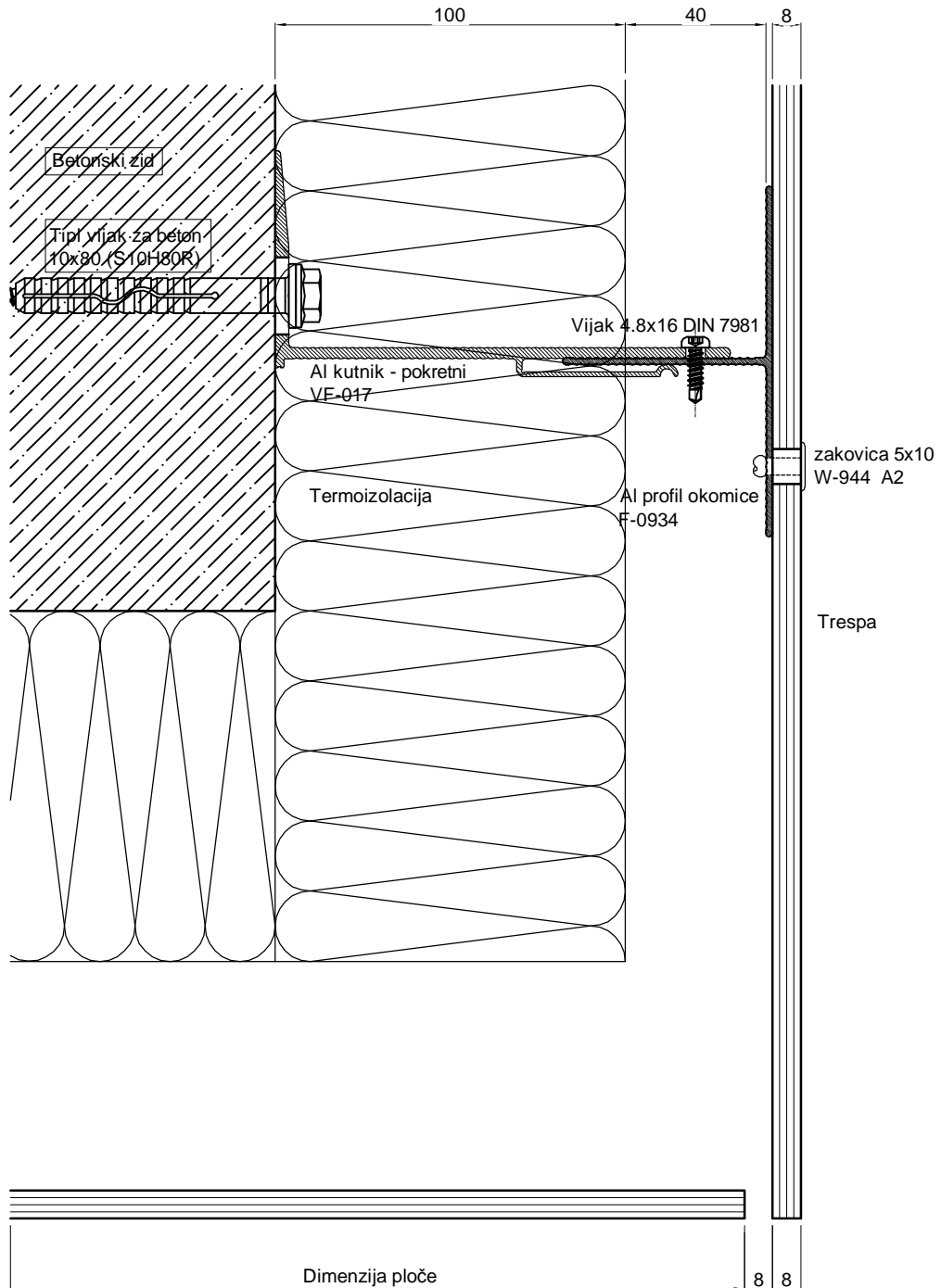

5

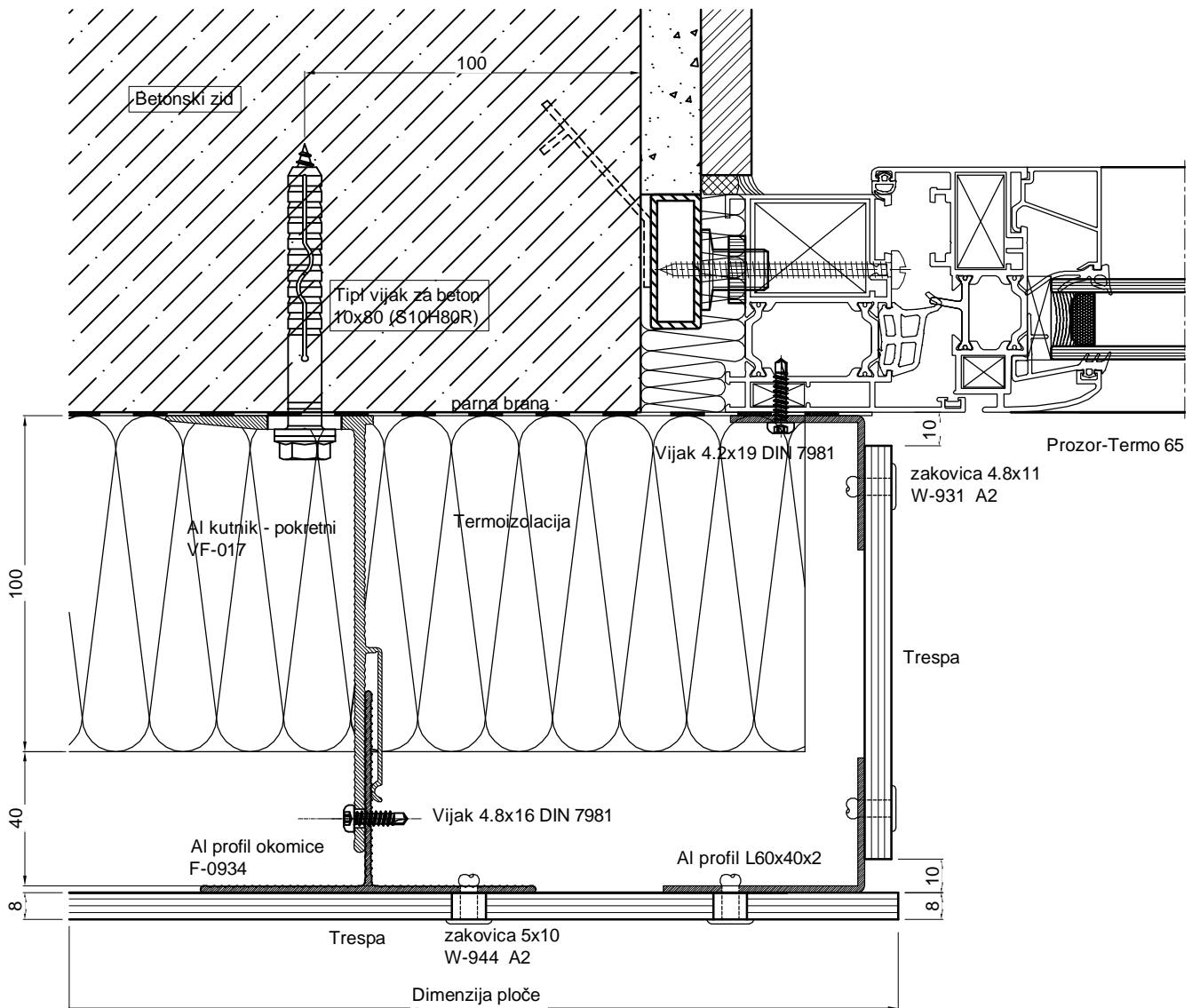

⑥

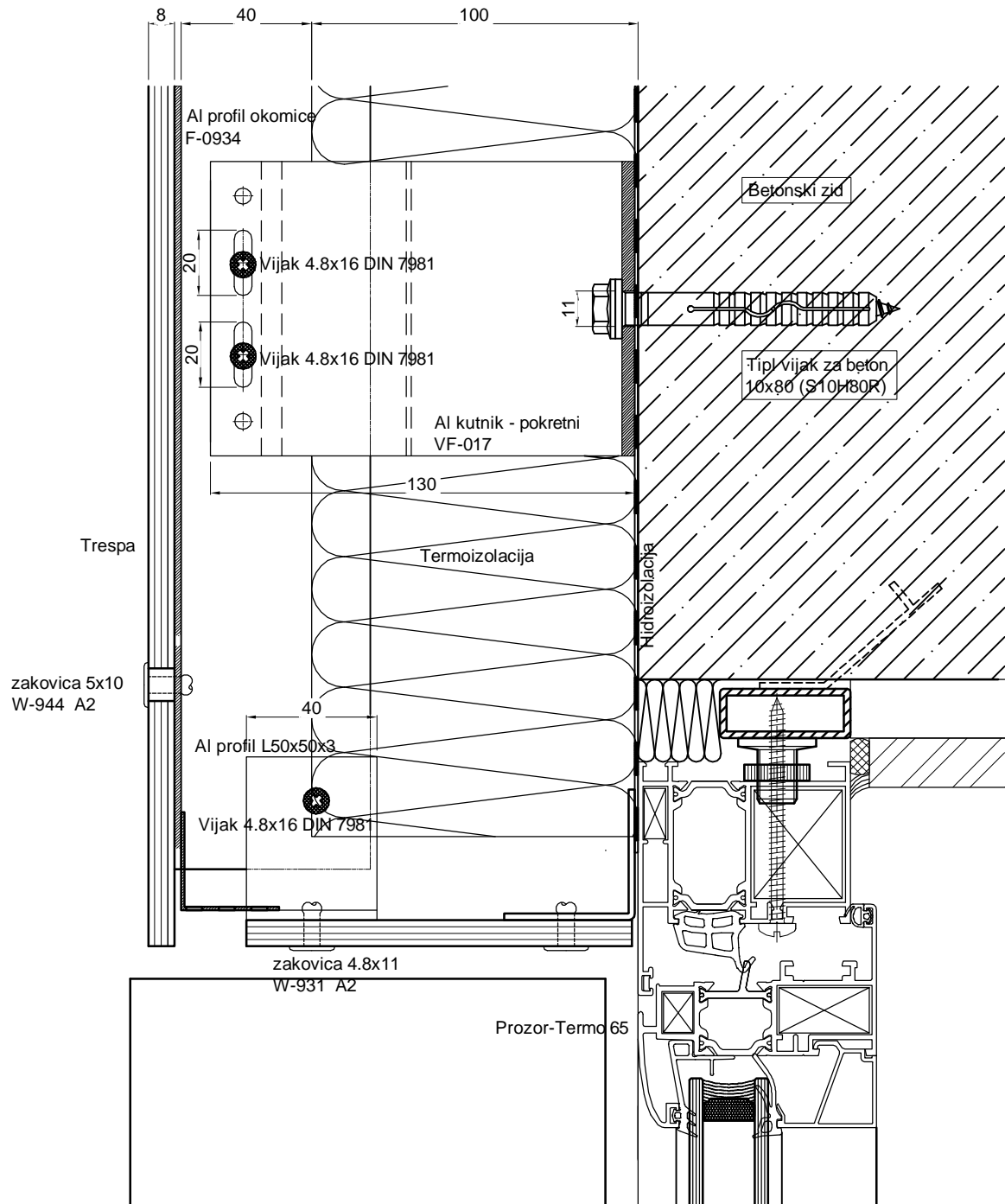

6A

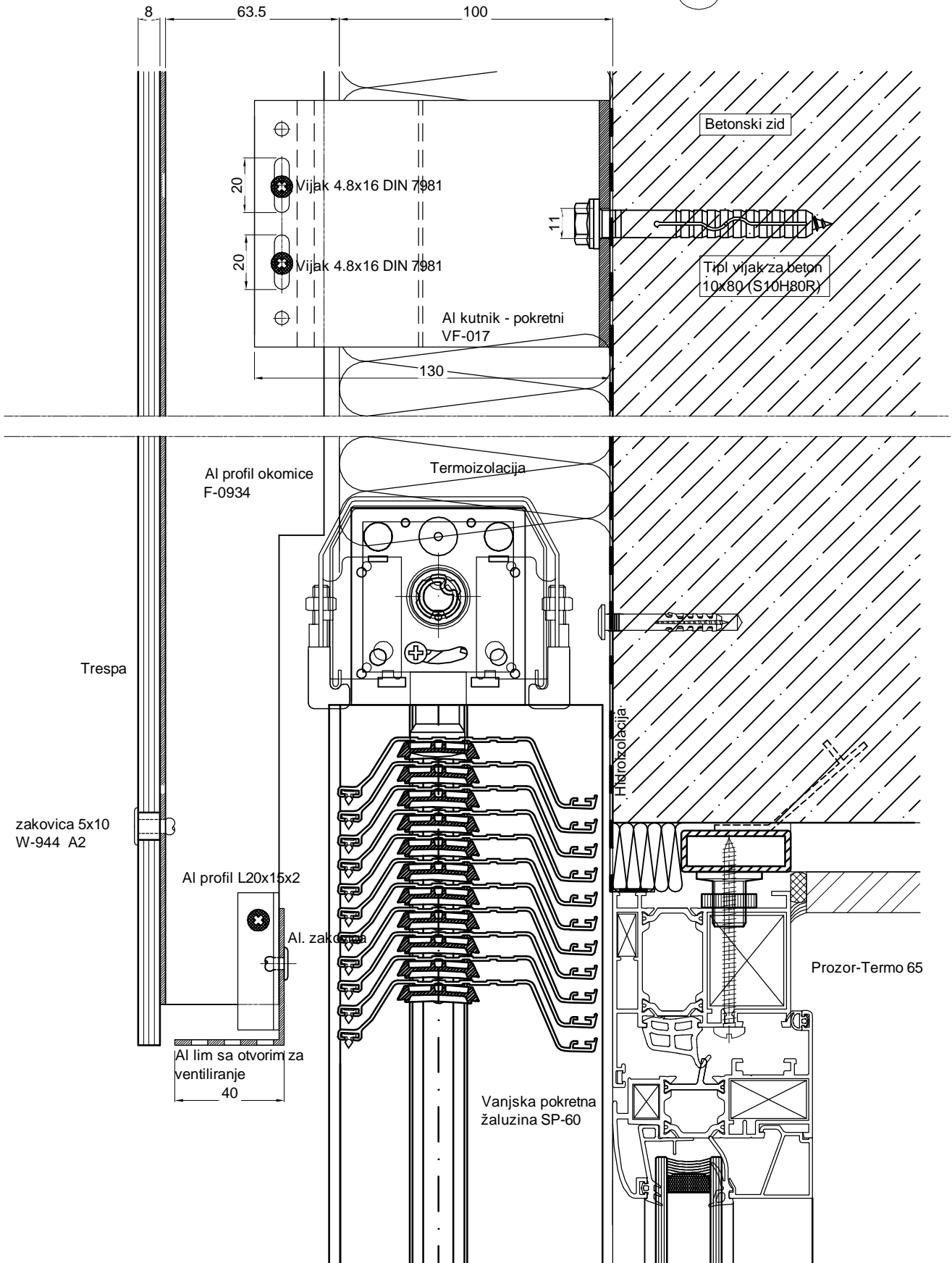

7

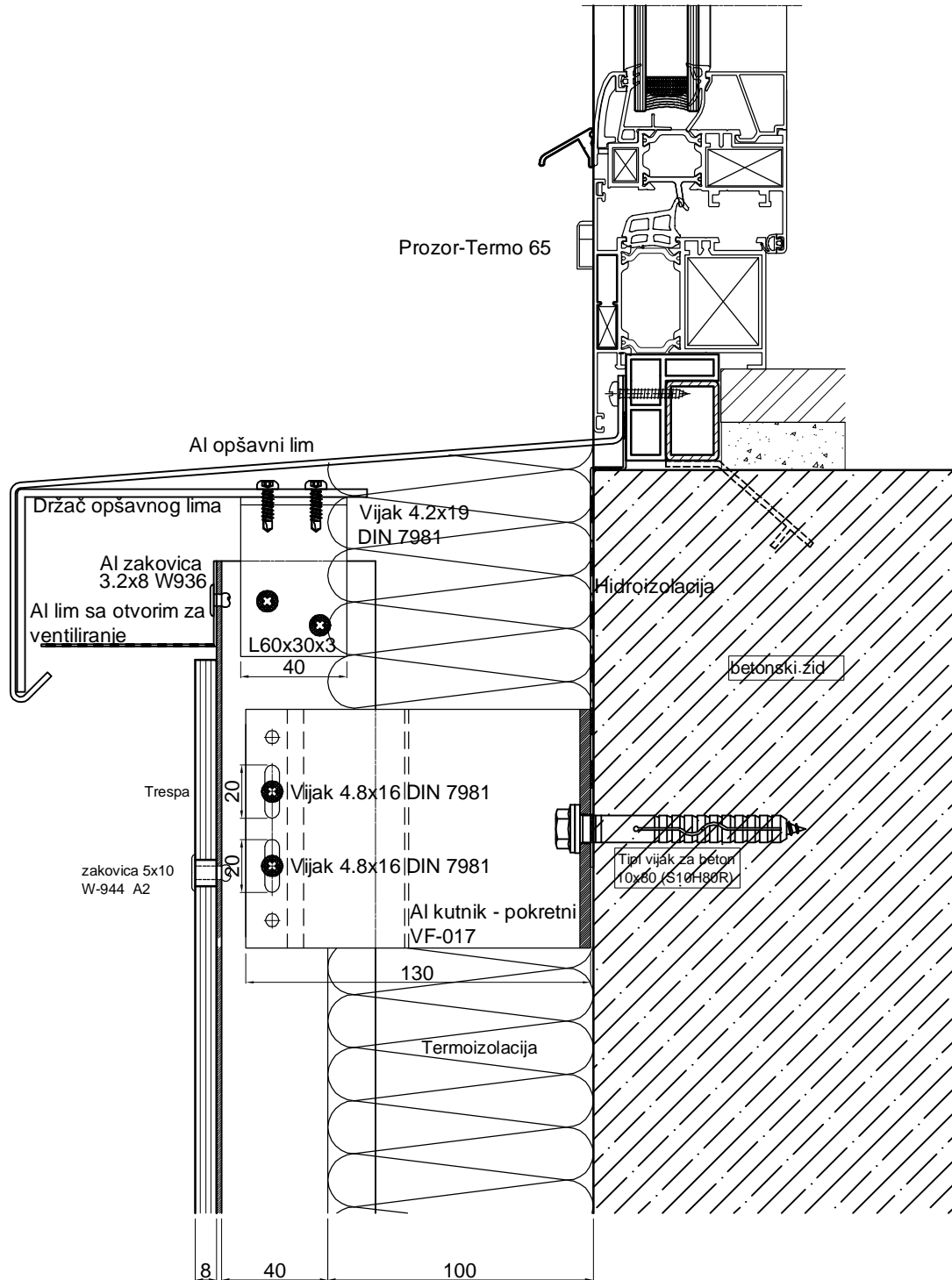

8

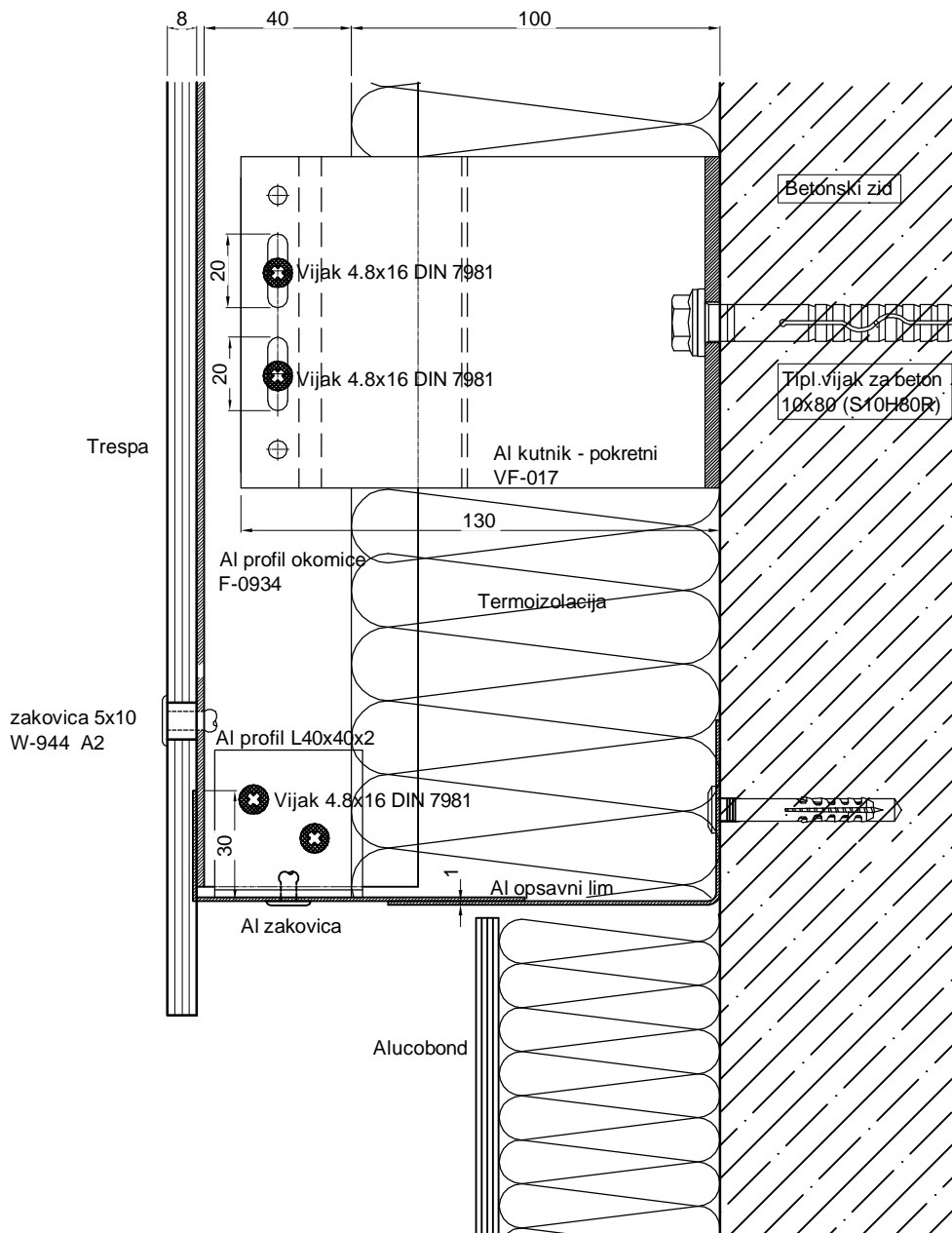

10

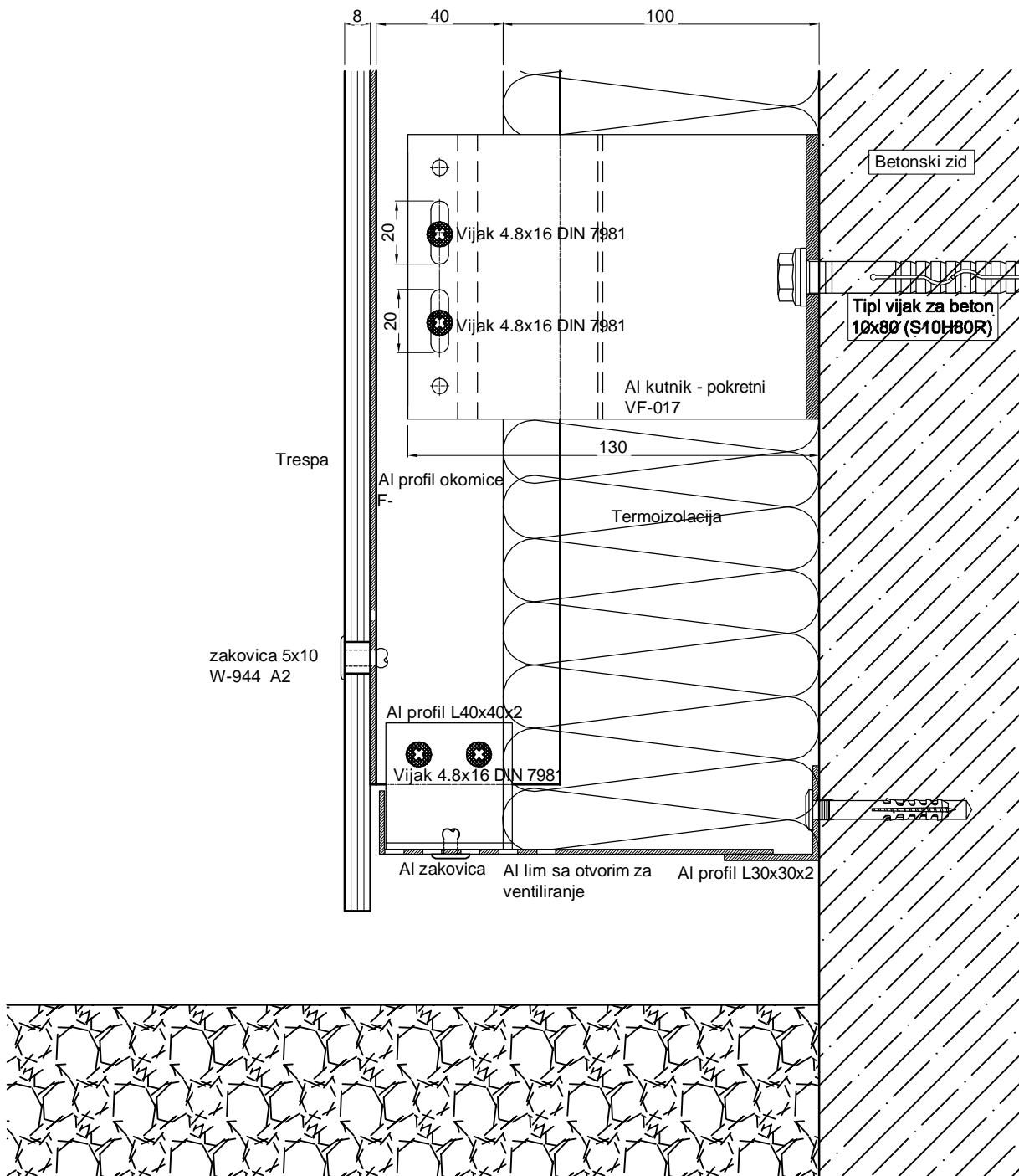

Presjeci

9

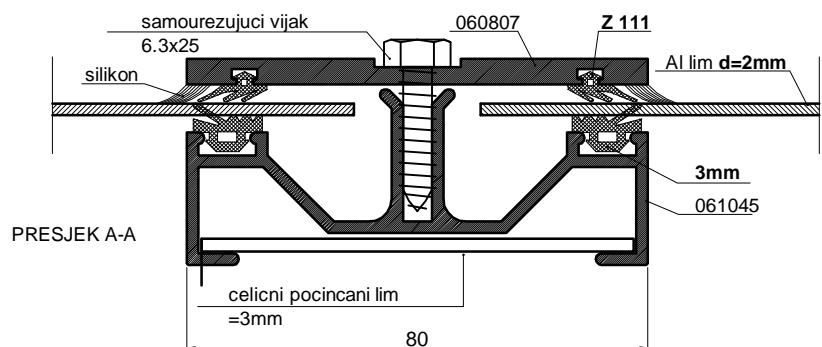
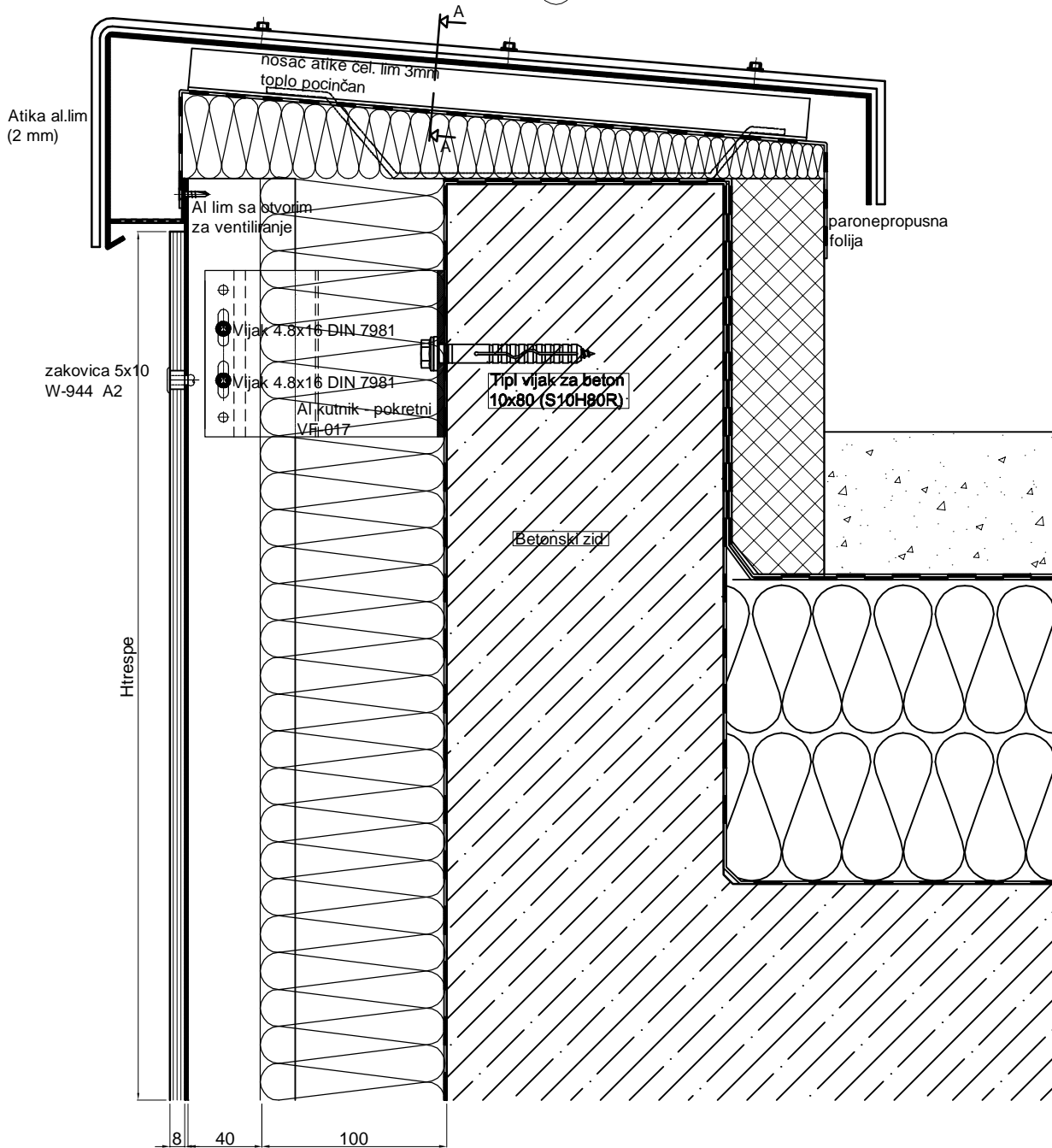

TRESPA

-obrade i montaža-

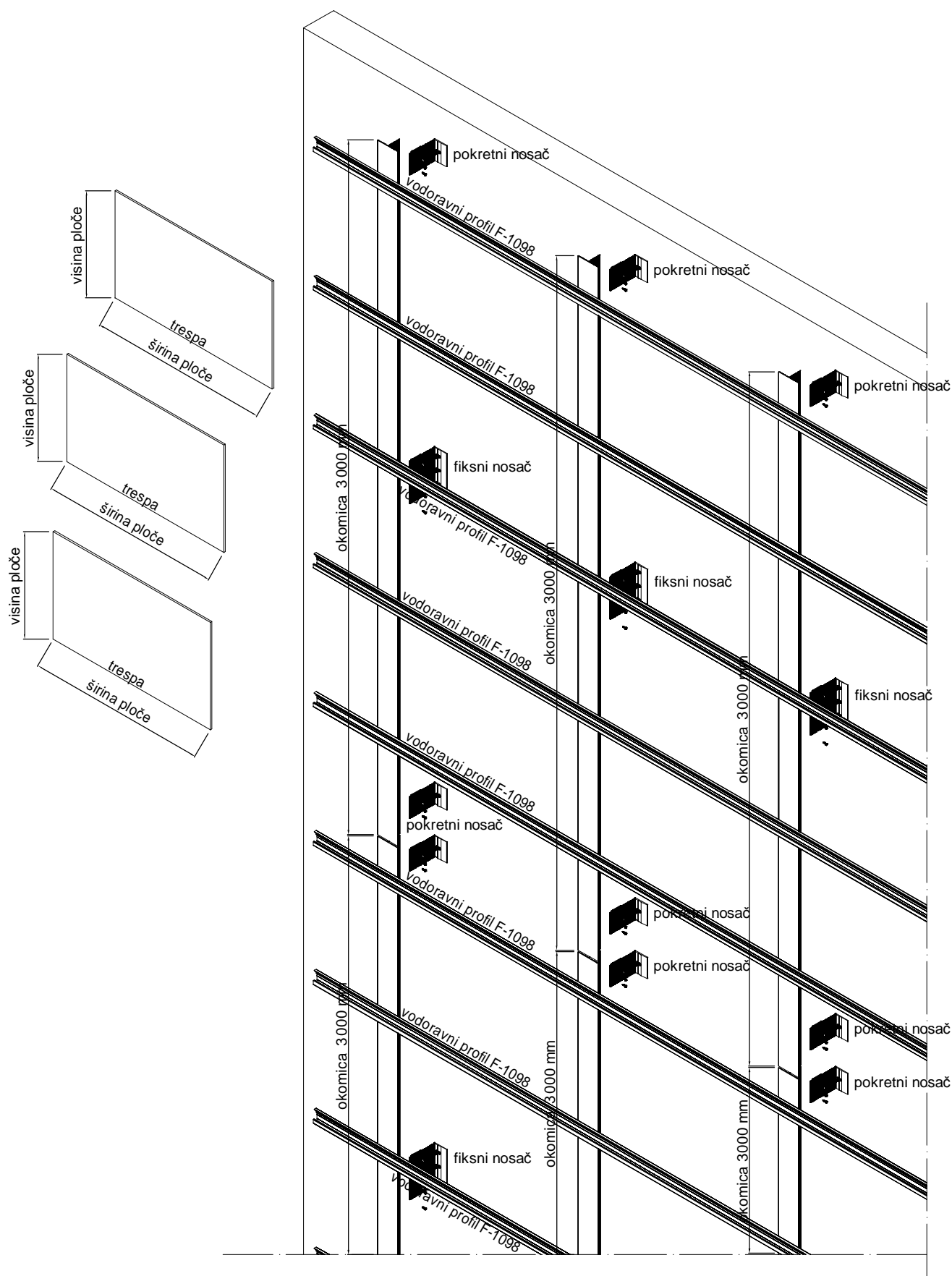

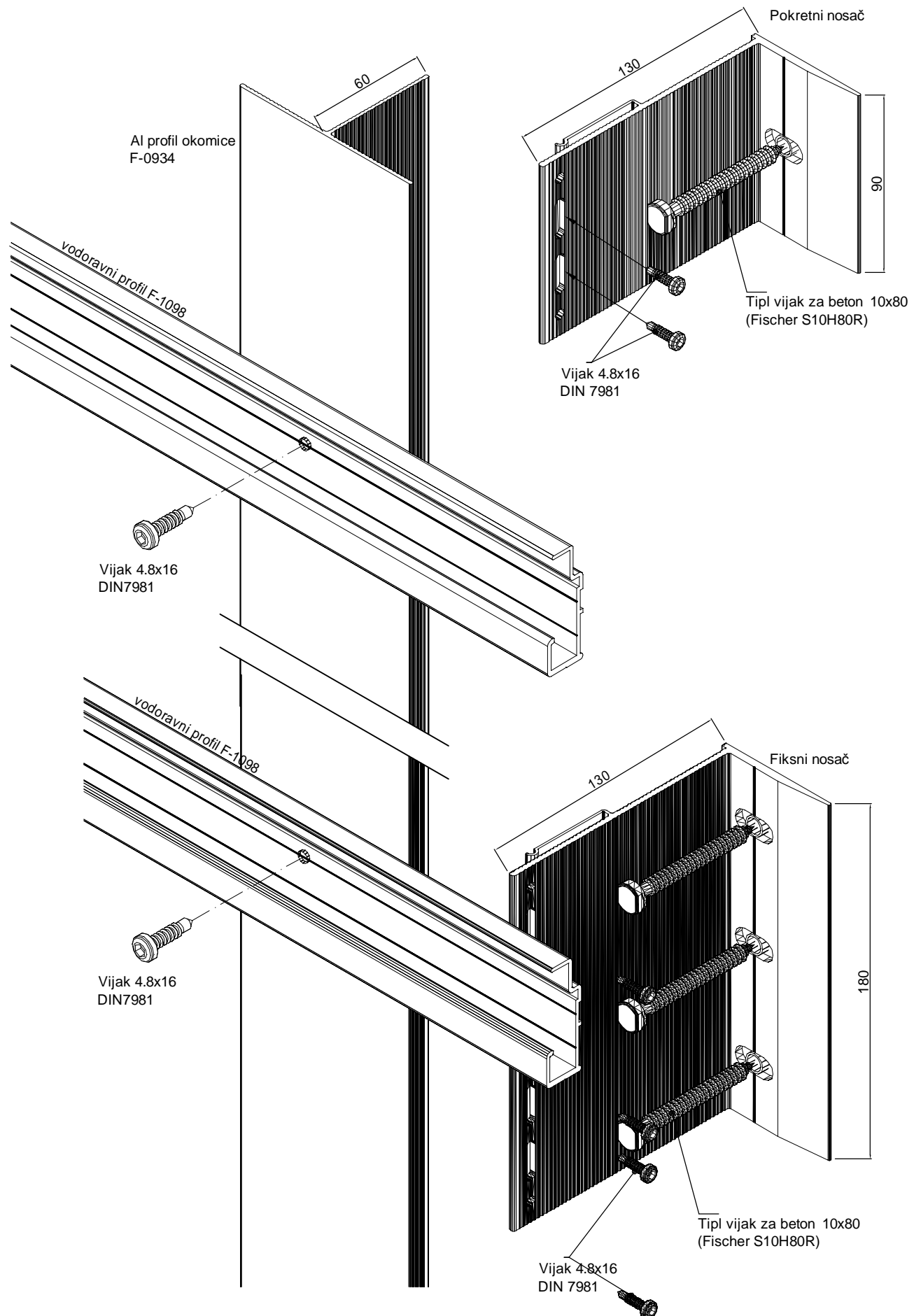

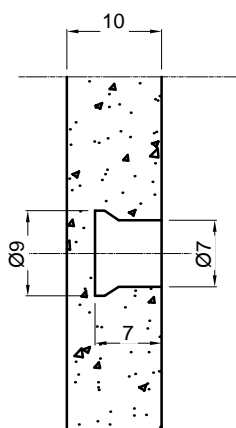

obrada trespe

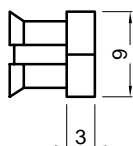

tipl za pričvršćivanje
nosača za trespu
(KEIL KH AA 555 020 780)

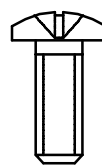

vijak M5x12 DIN 966
za podešavanje visine

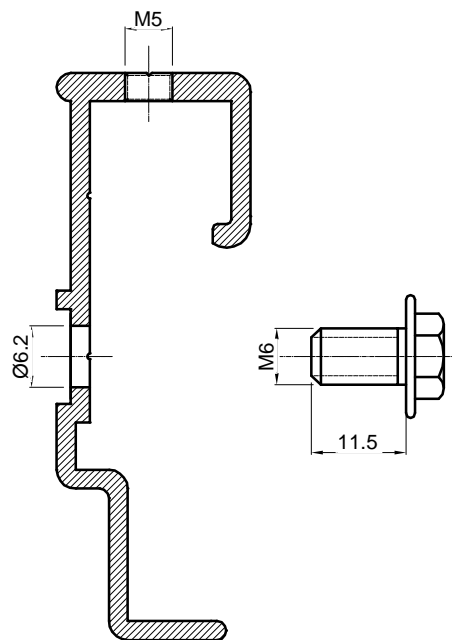

nosač trespe KS-T50

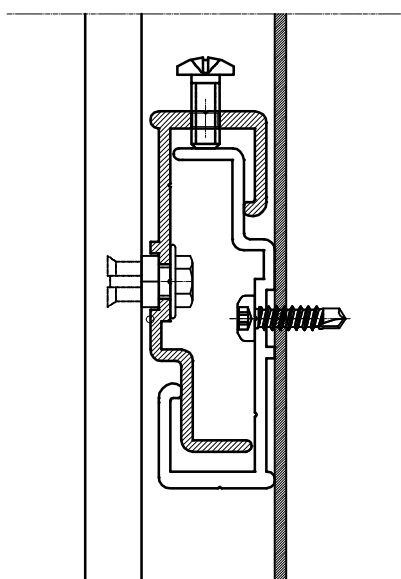

Montaža

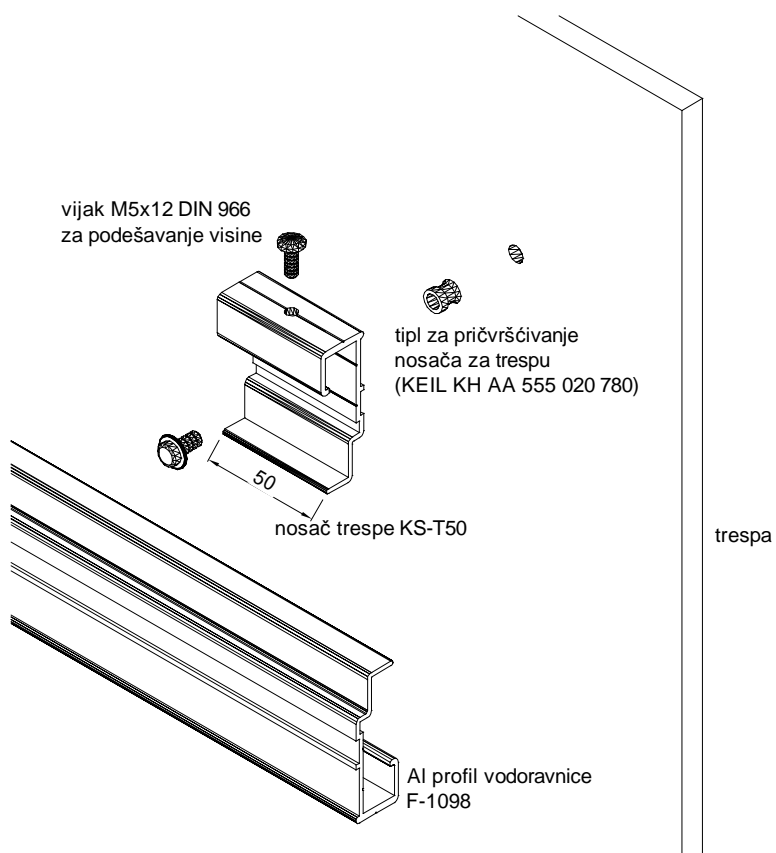
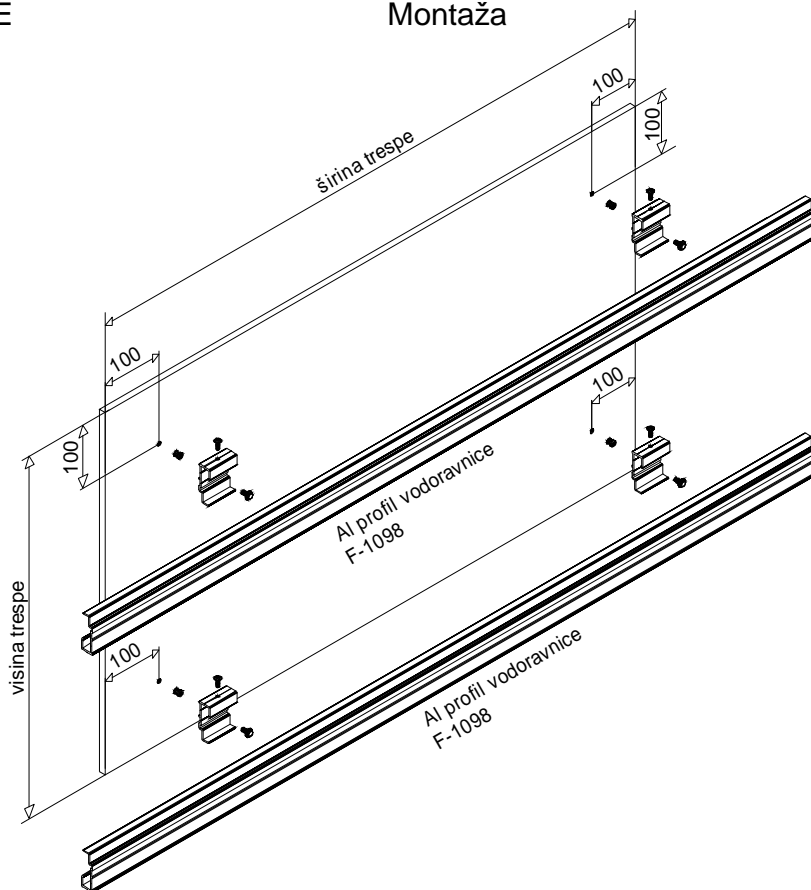

shema fiksiranja trespe

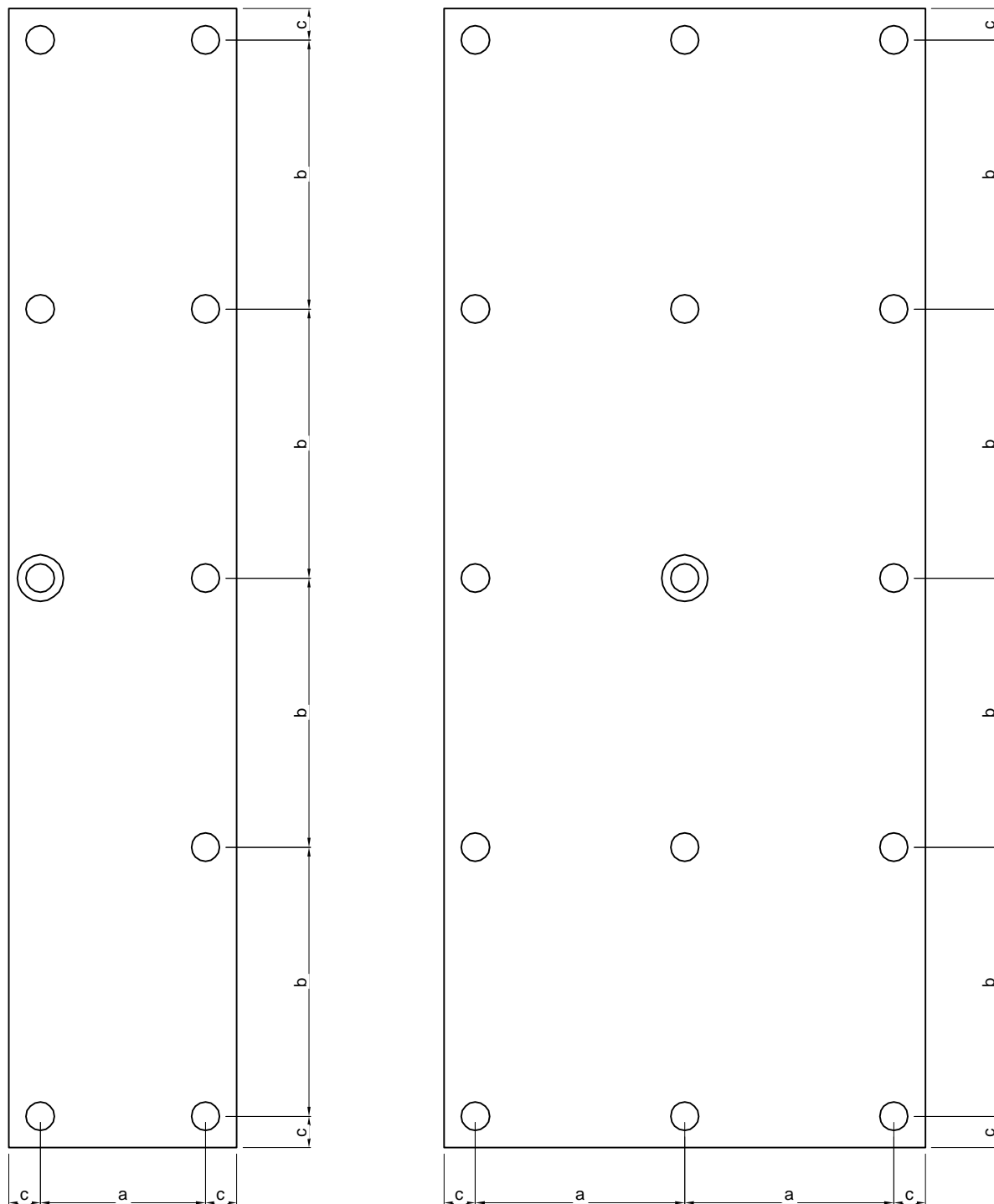

a-horizontalni razmak između fiksni točki (600 mm)
 b-vertikalni razmak između fiksni točki (600 mm)
 c-udaljenost od kraja ploče (max.80 mm)

fiksna točka

pokretna točka

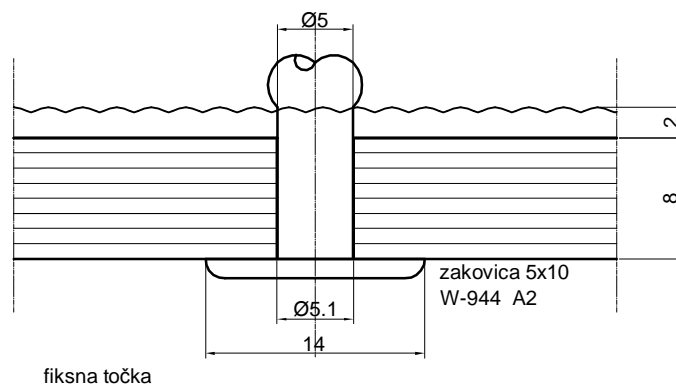
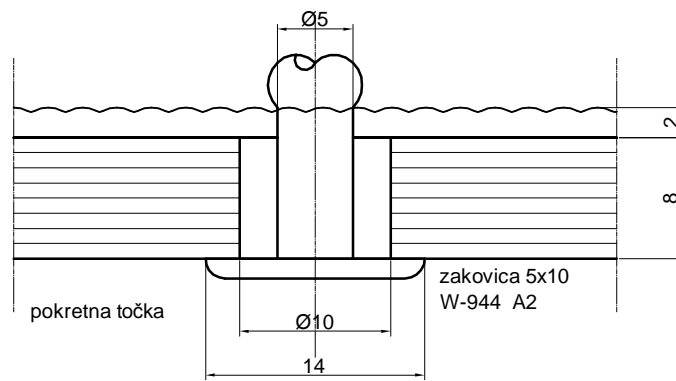

VENTILIRAJUĆE
FASADNE OBLOGE

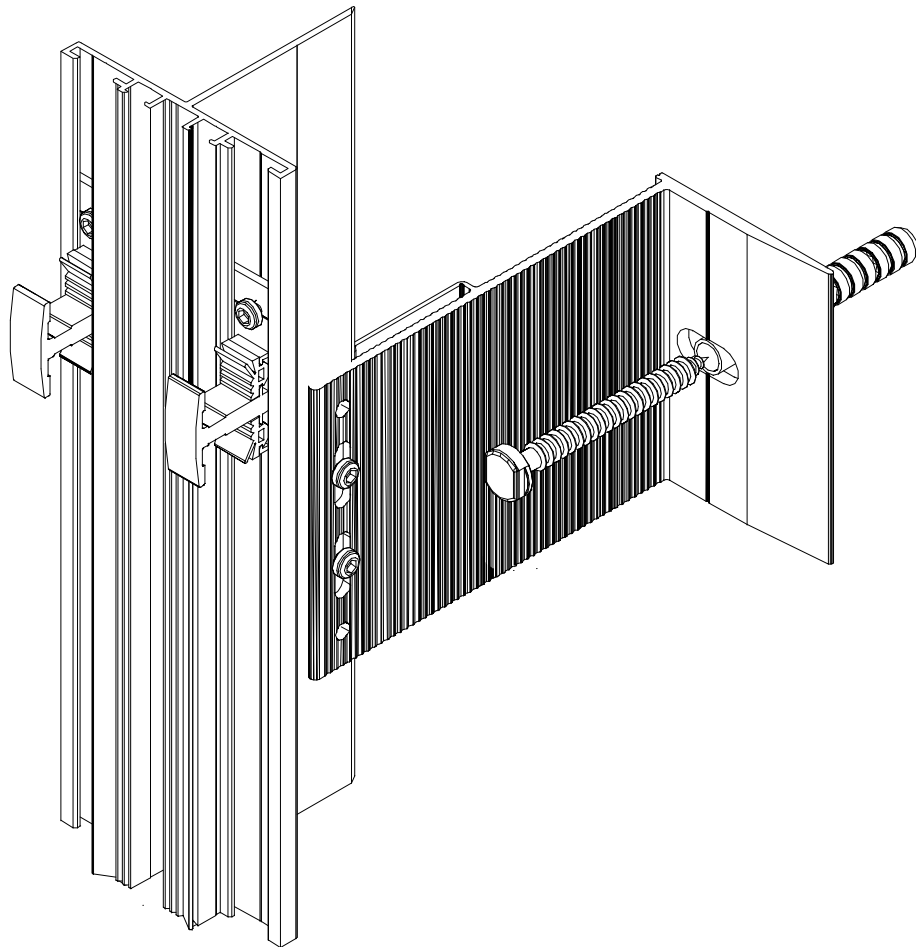

KERAMIČKA FASADA SA
VIDLJIVOM KOPČOM
K-1

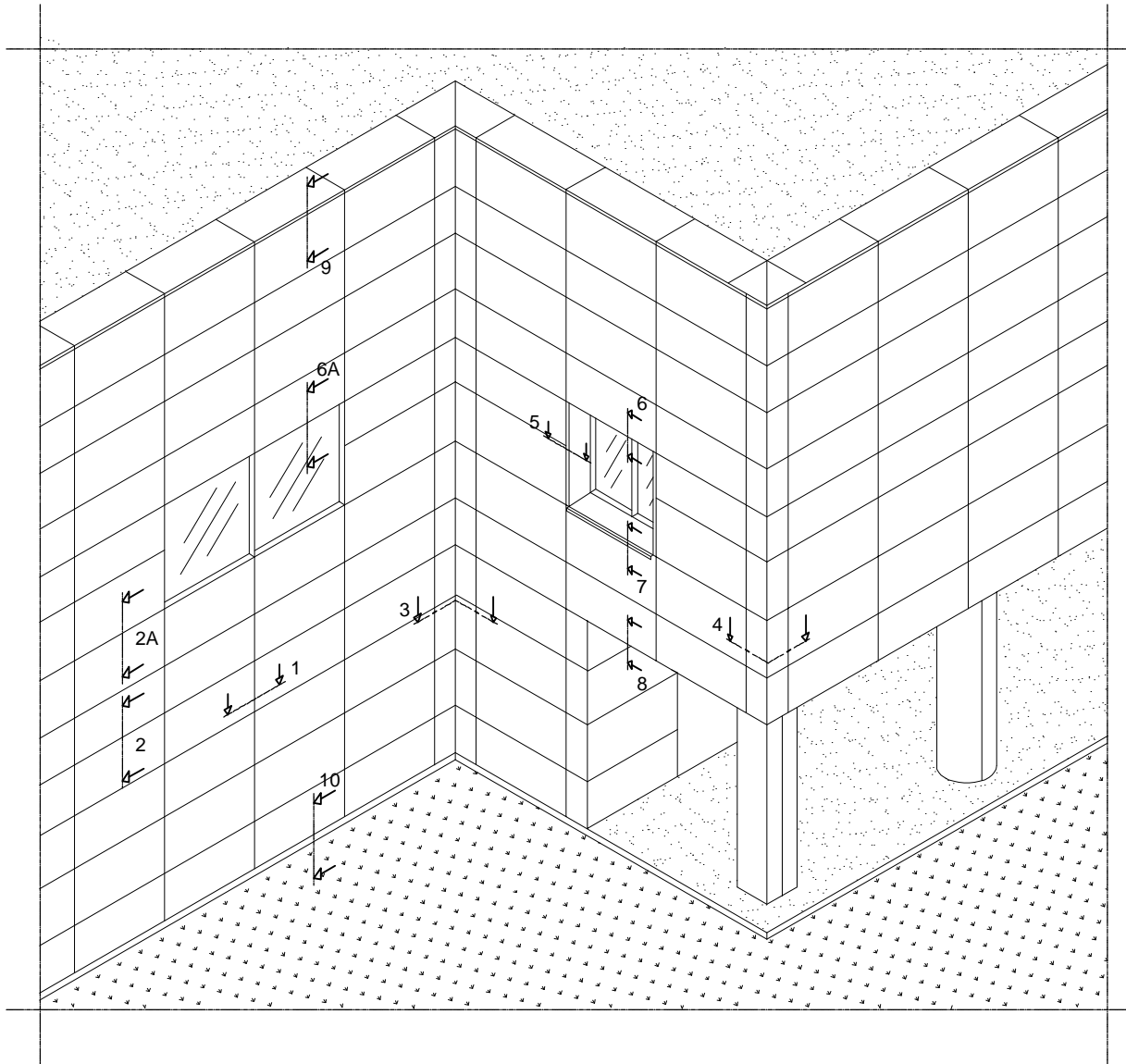

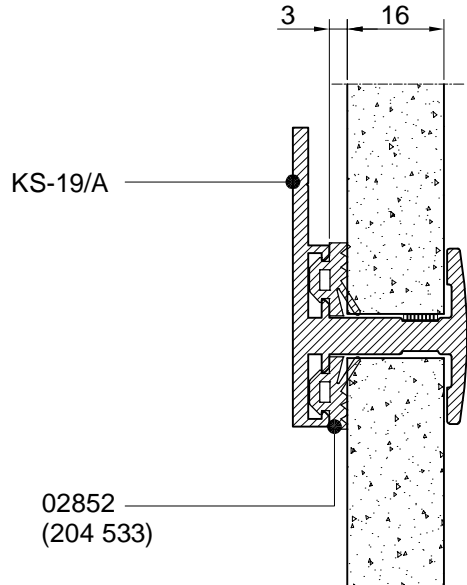
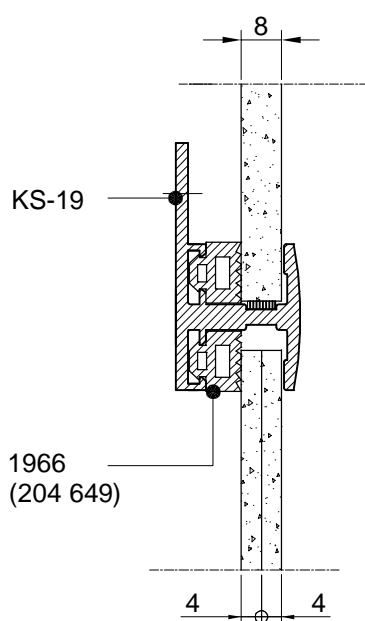
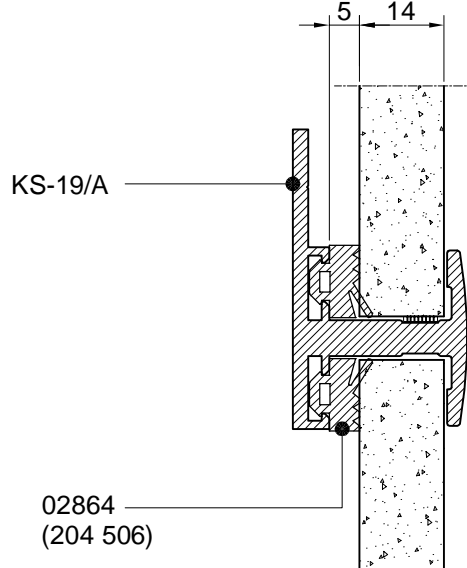
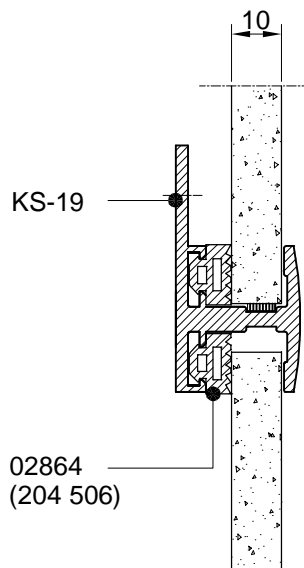
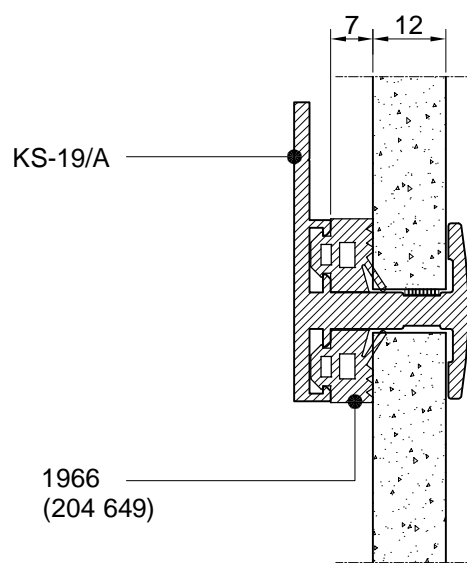
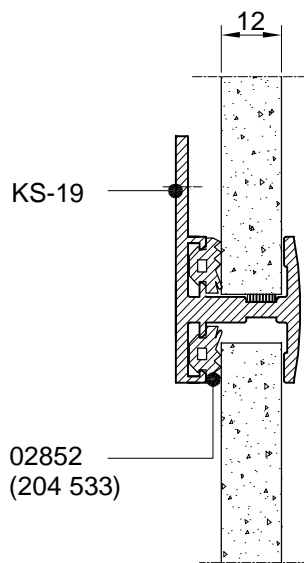

- ① kutnik VF-014/VF-015 fiksni /pokretni/
L=90 mm
- ② kutnik K2 VF-016/VF-017 fiksni /pokretni/
L=130 mm
- ③ profil okomice KF-001

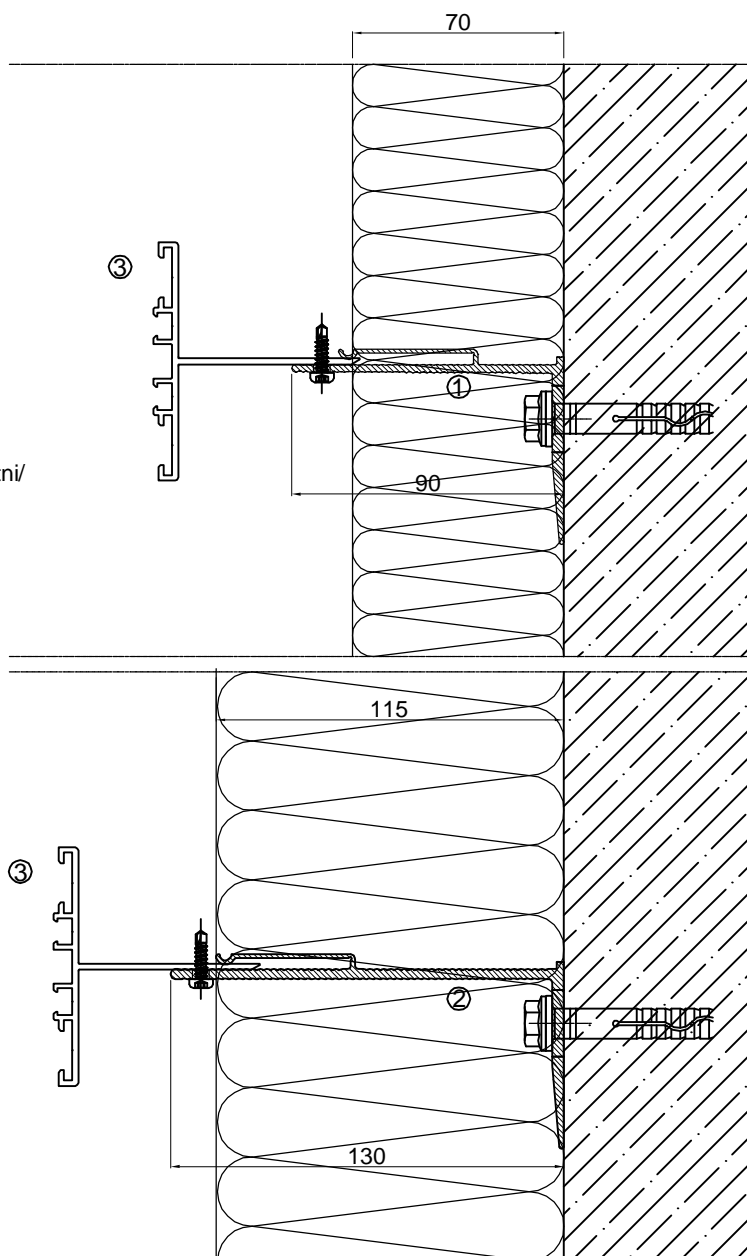

①

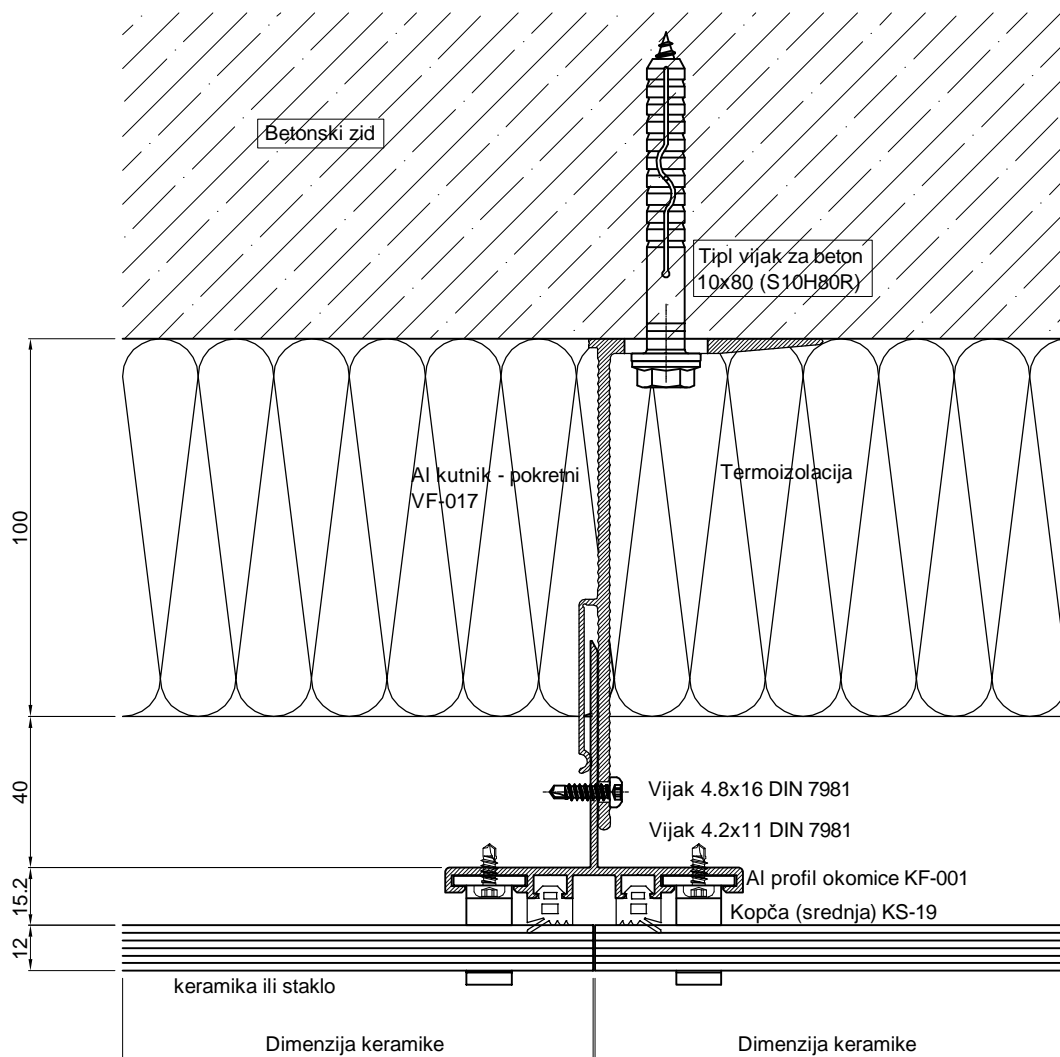

②

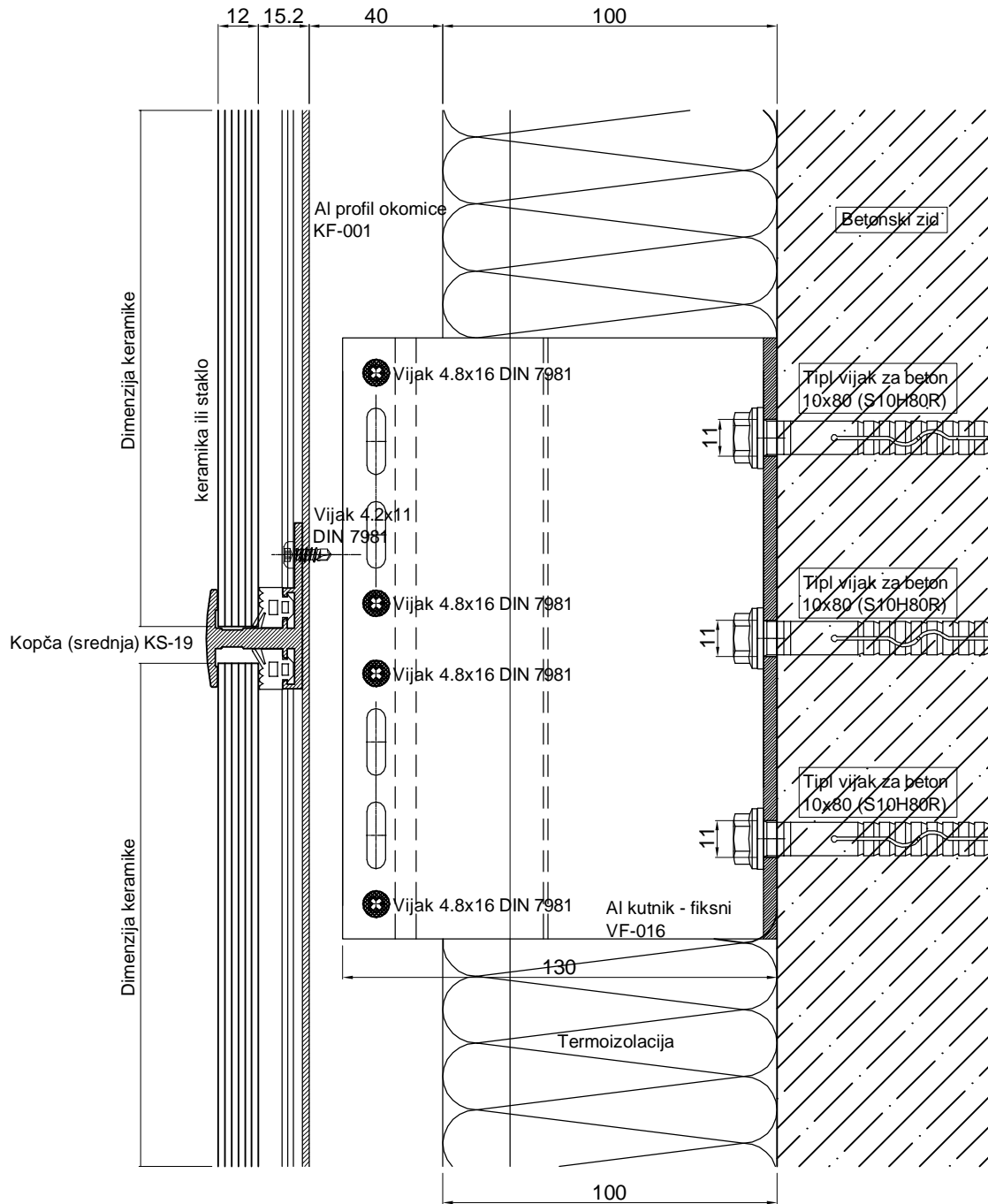

2A

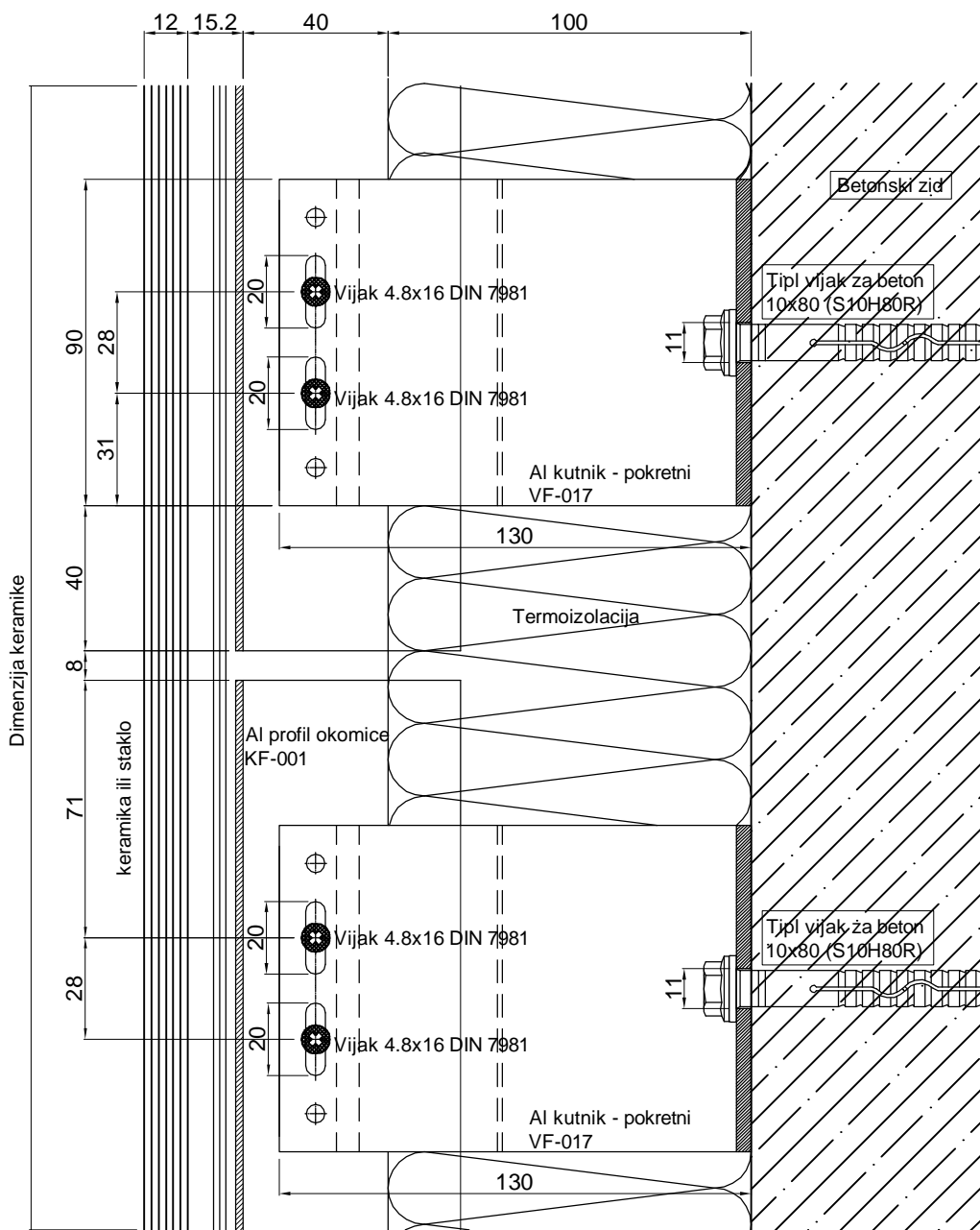

③

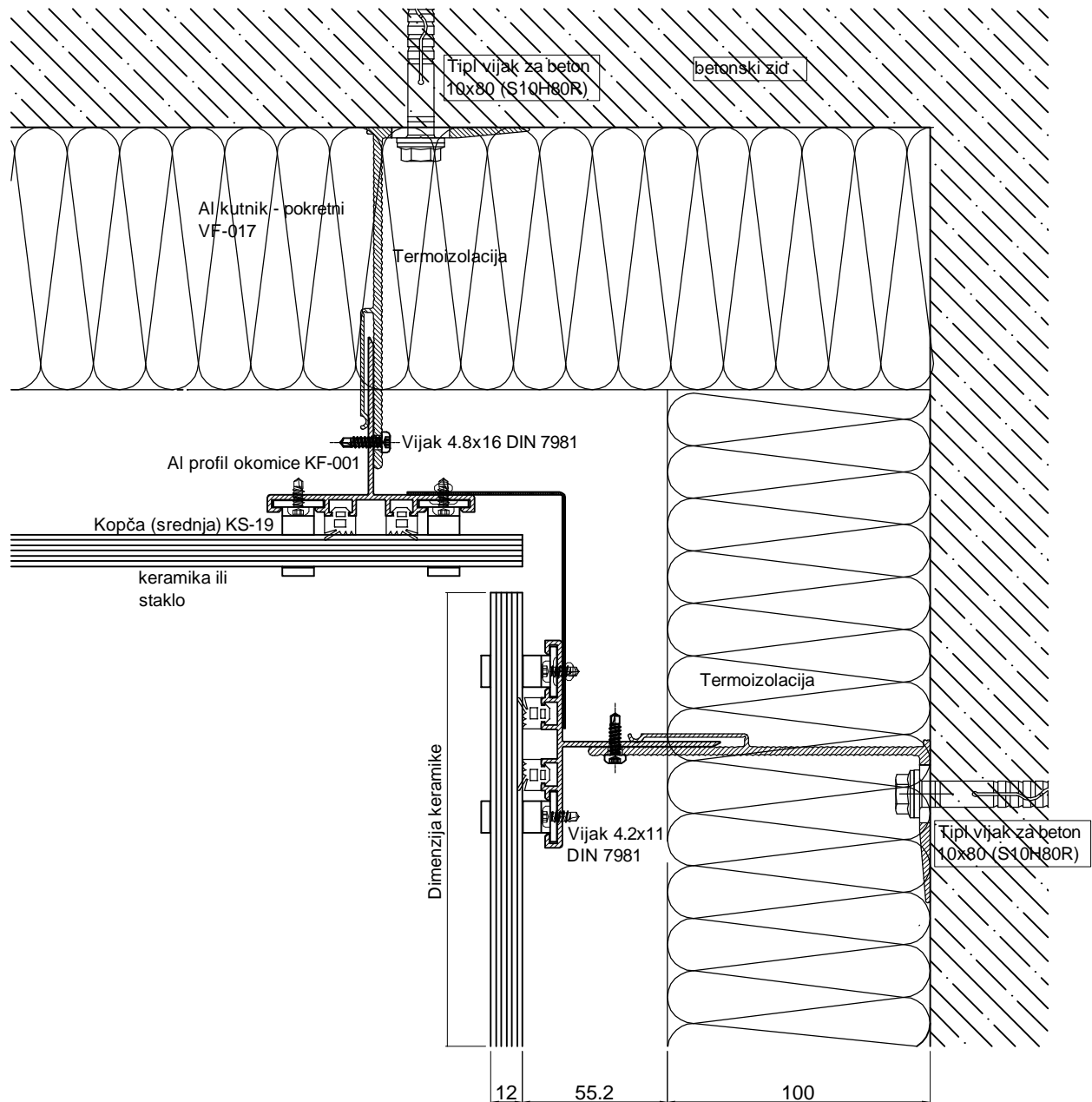

④

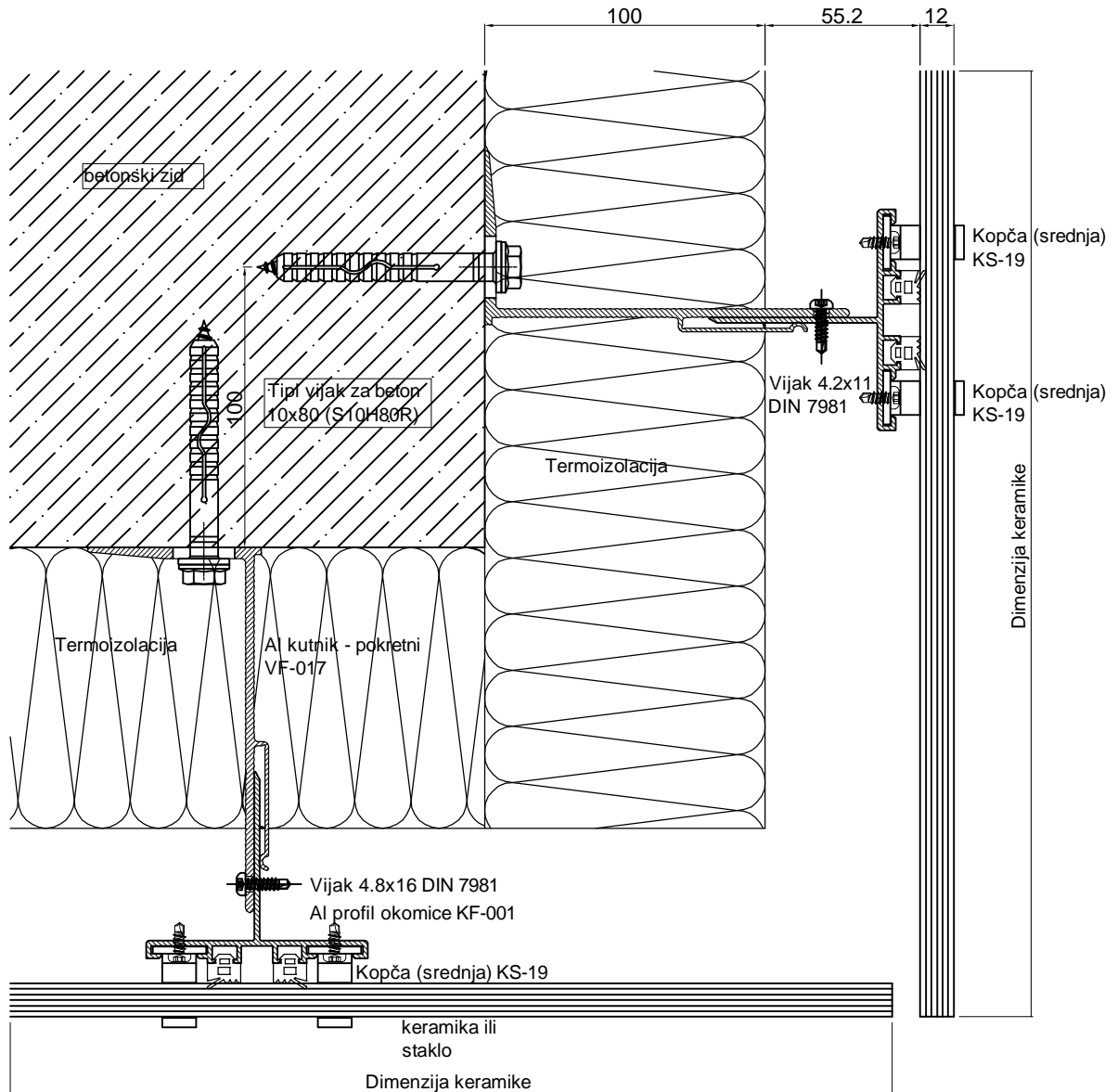

5

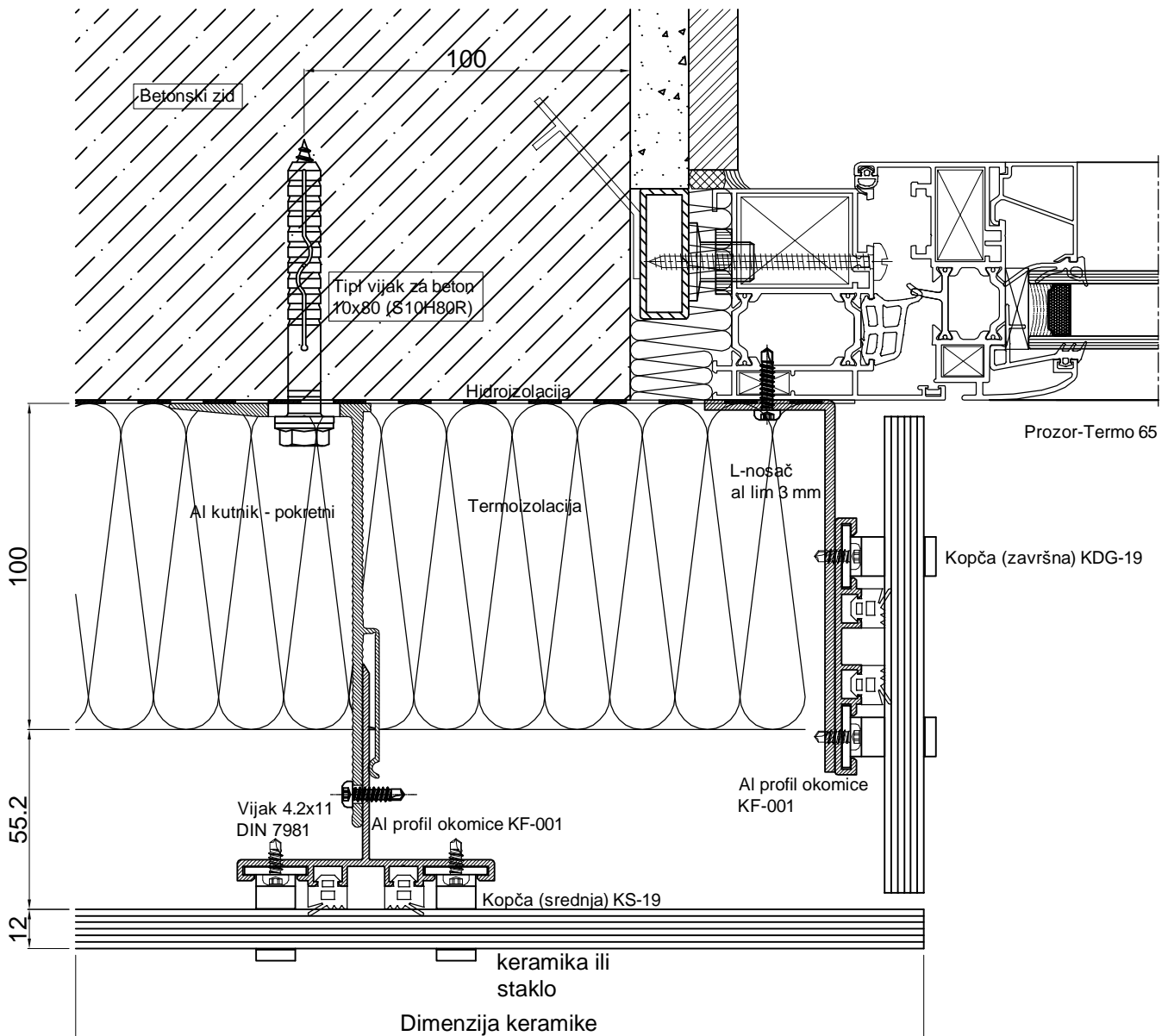

⑥

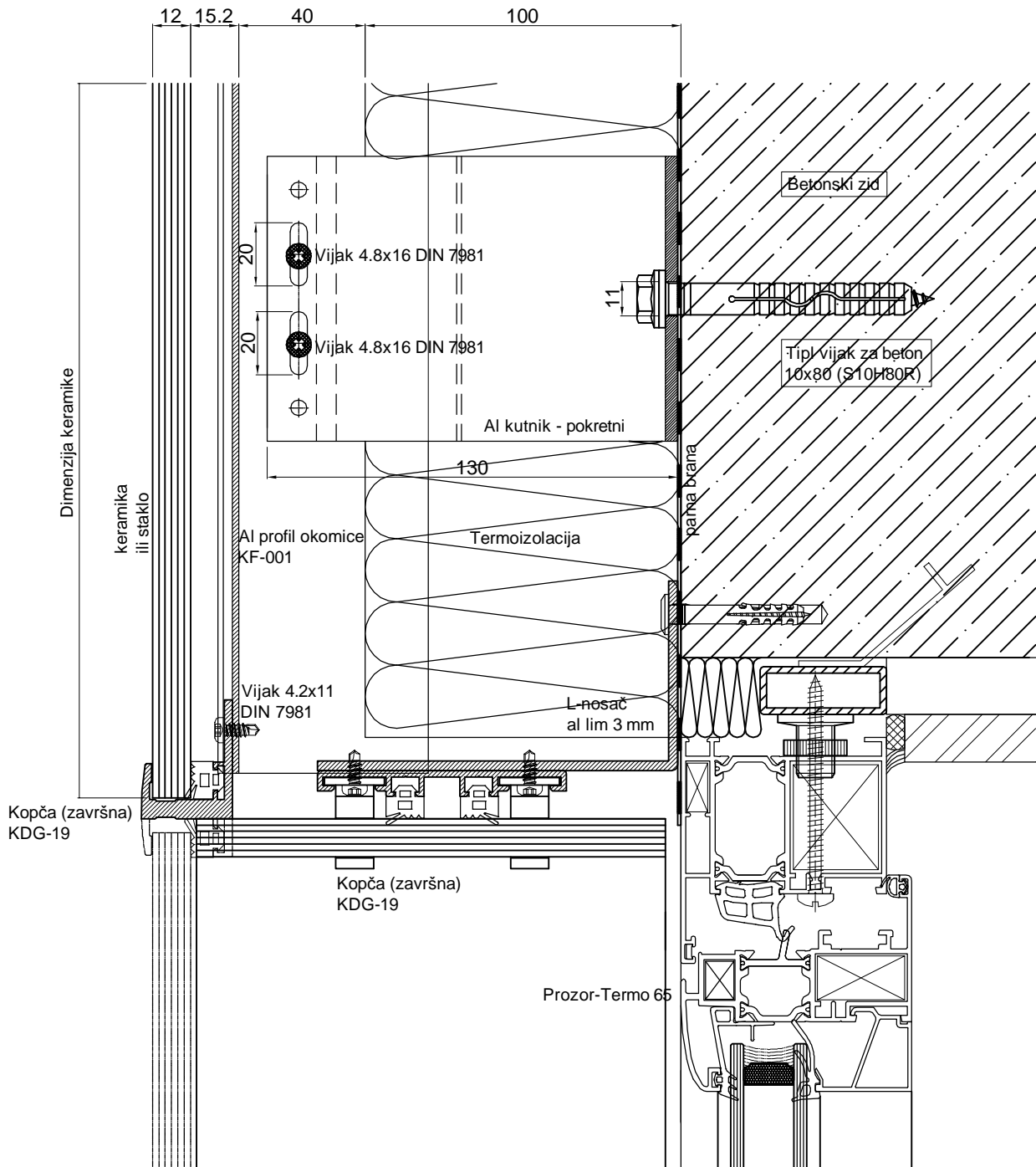

6A

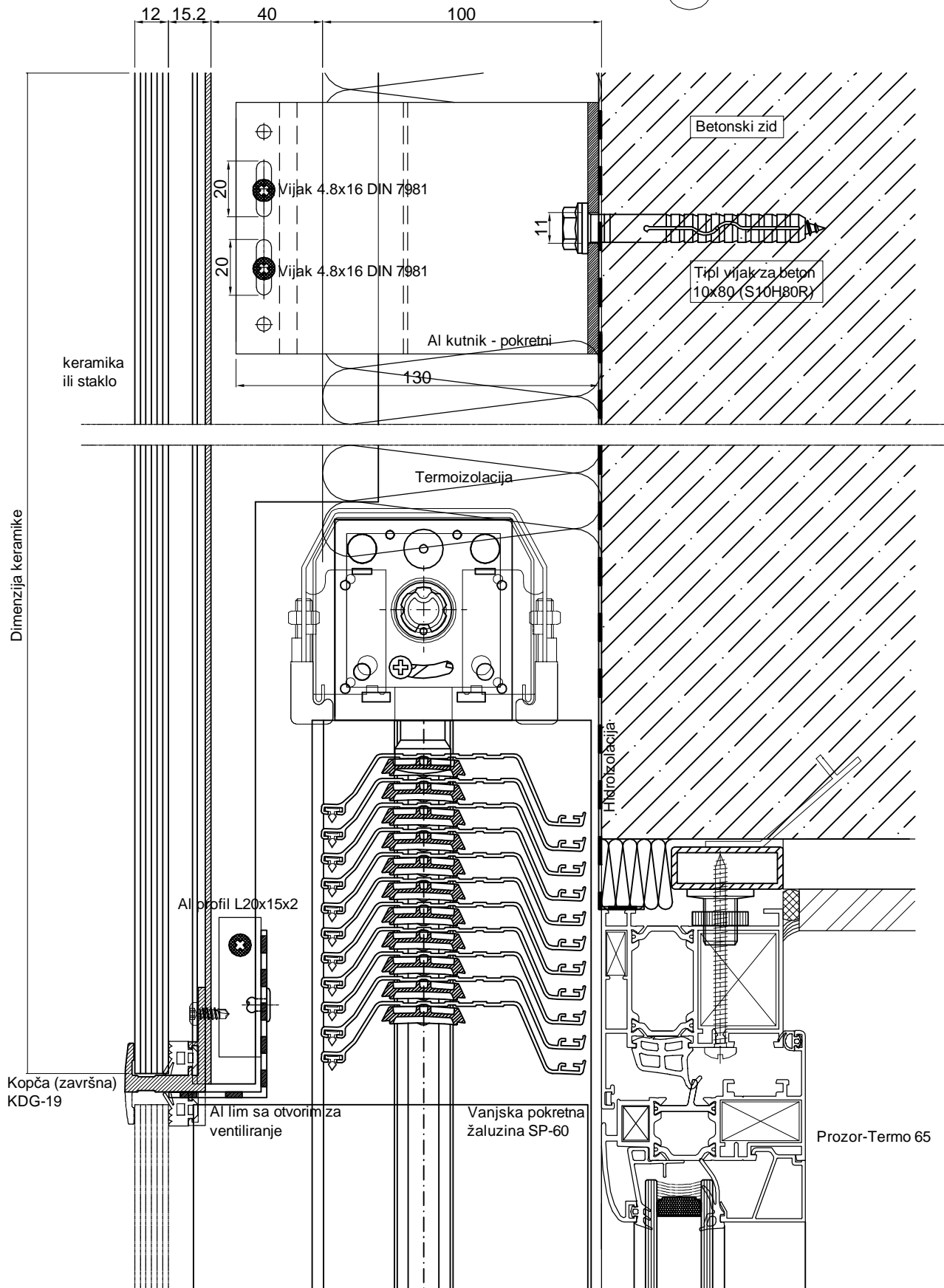

7

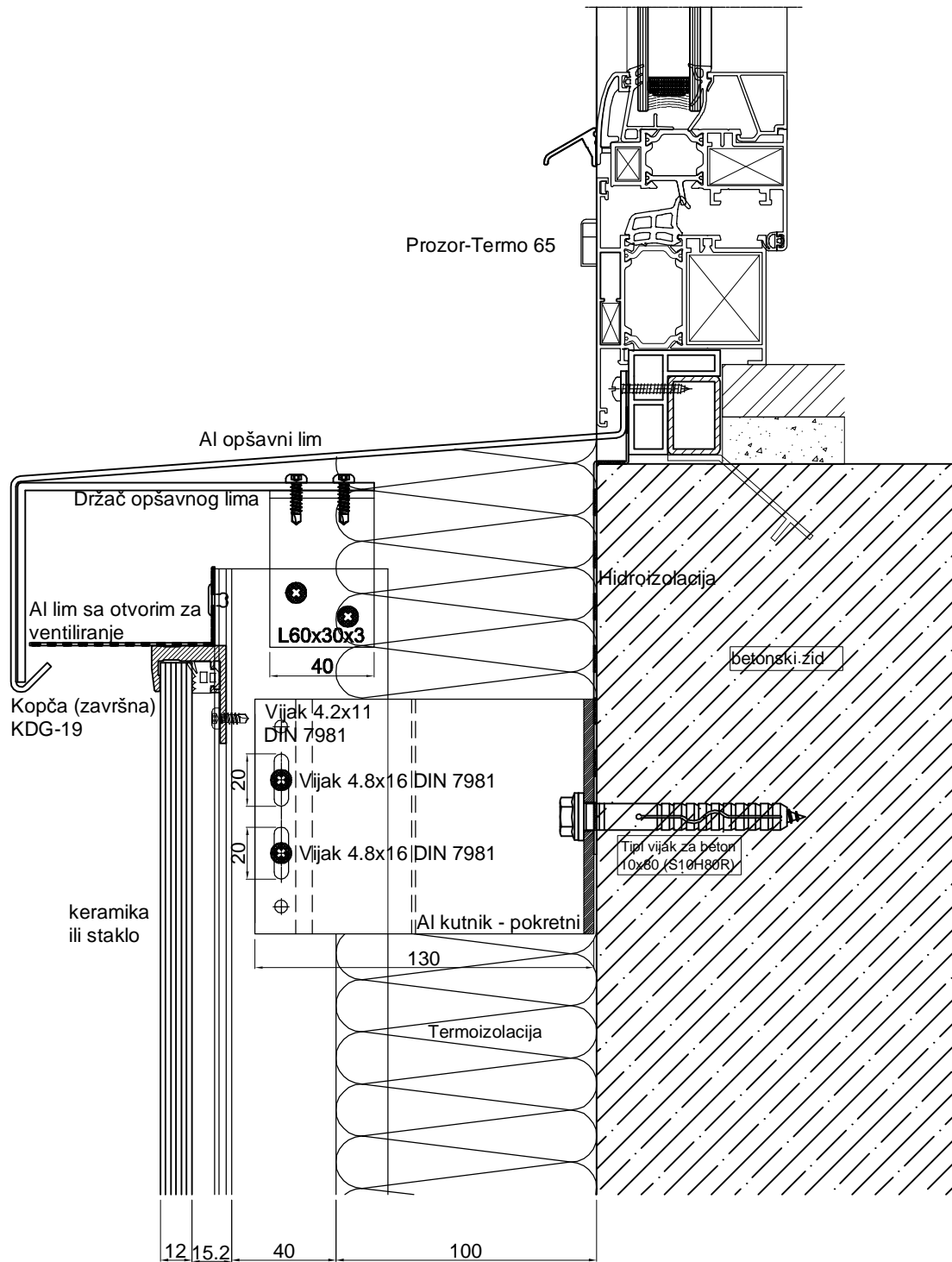

8

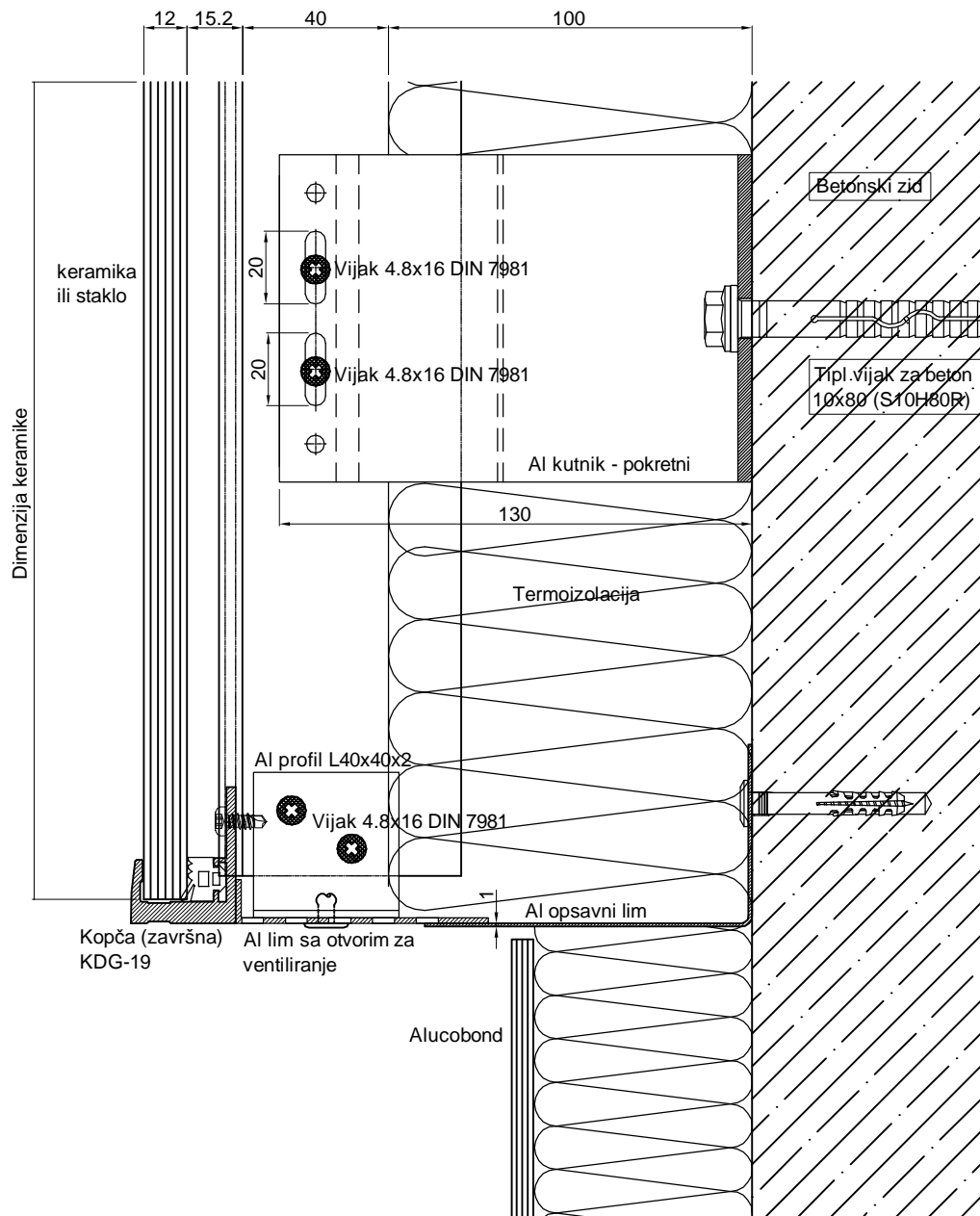

10

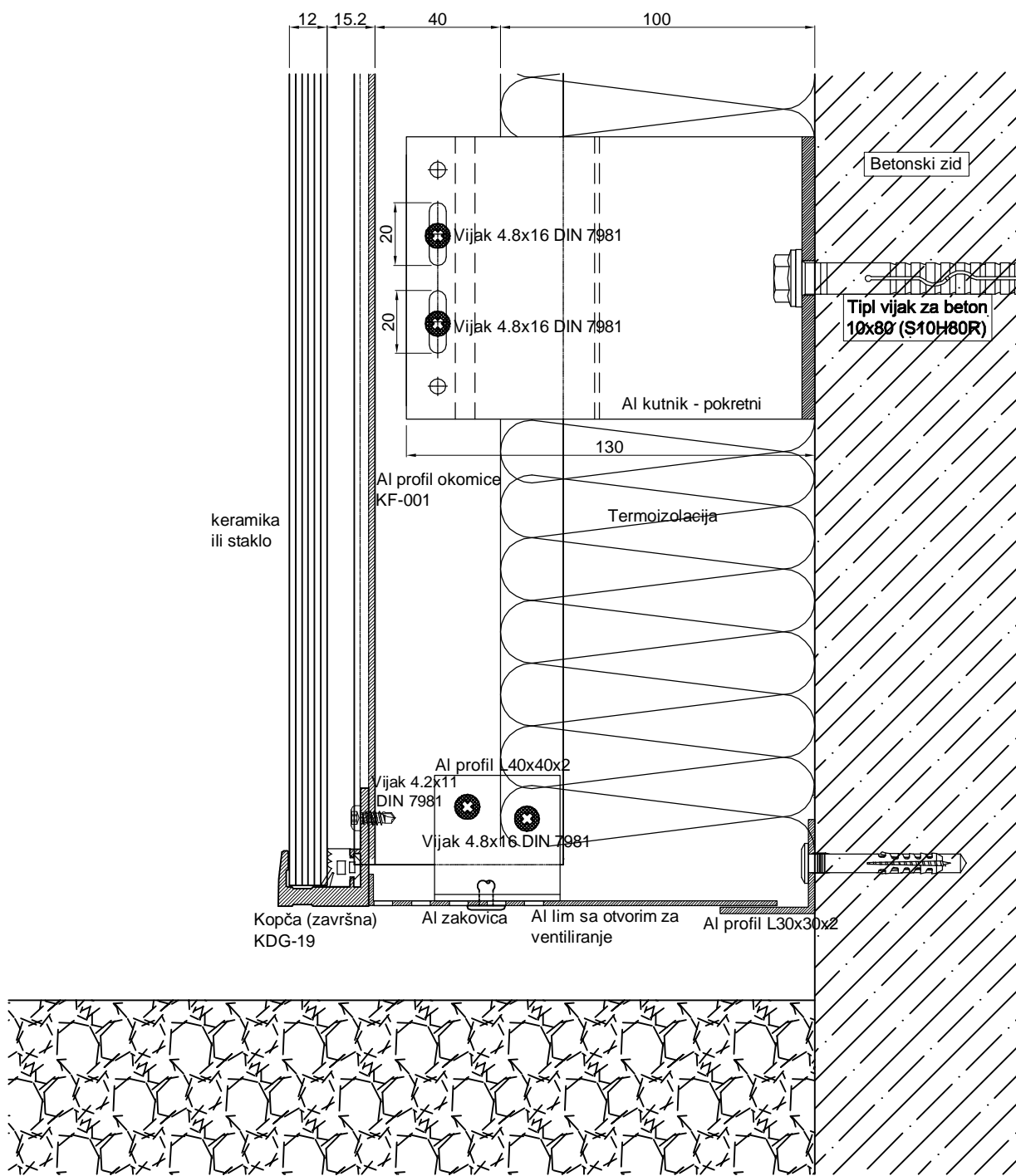

9

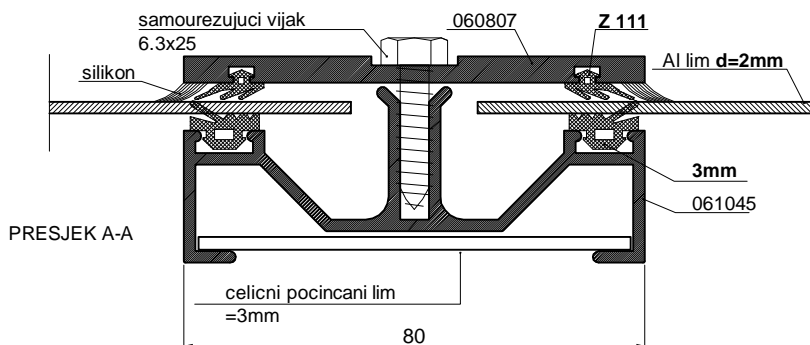
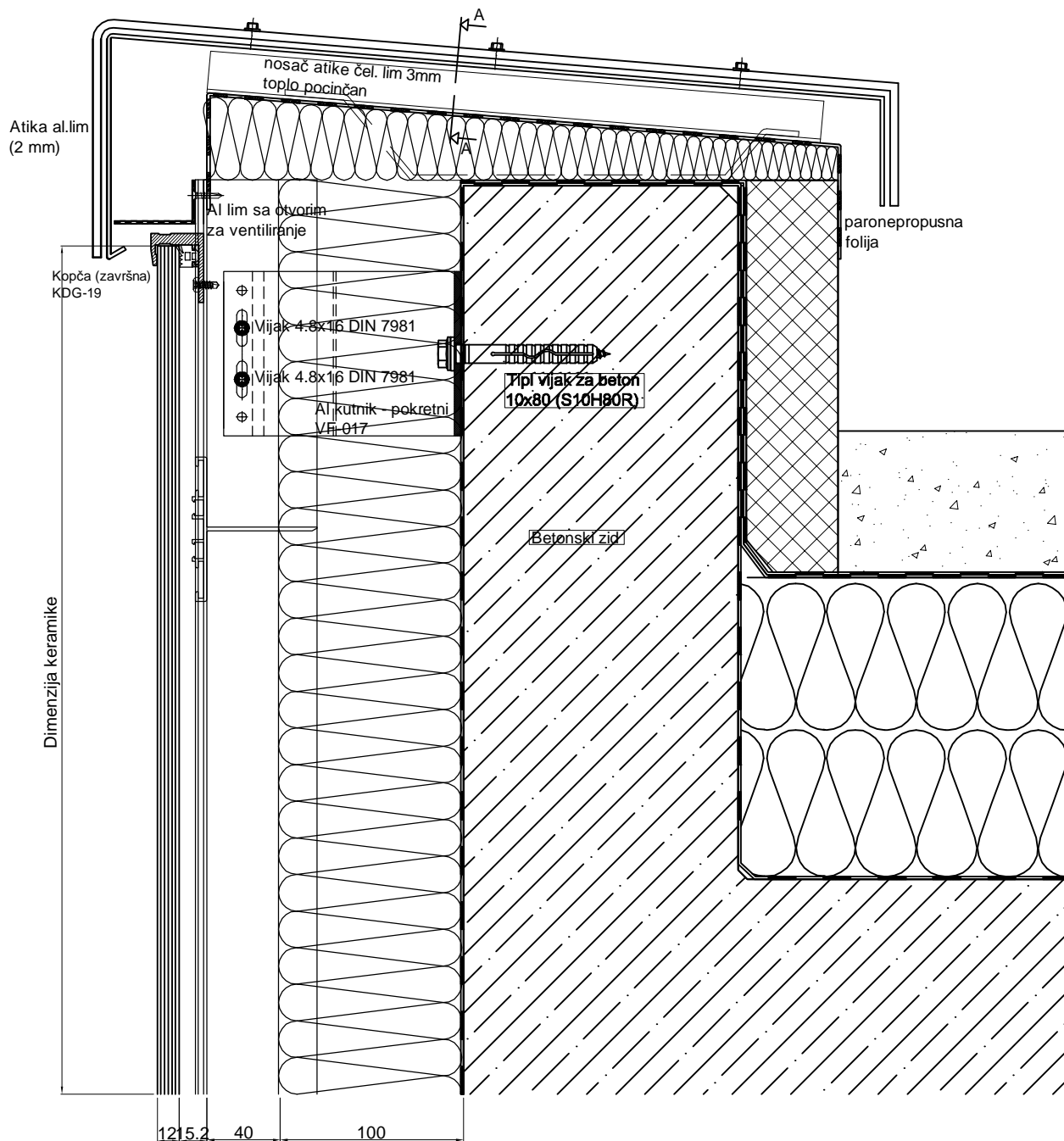

VENTILIRAJUĆE
FASADNE OBLOGE

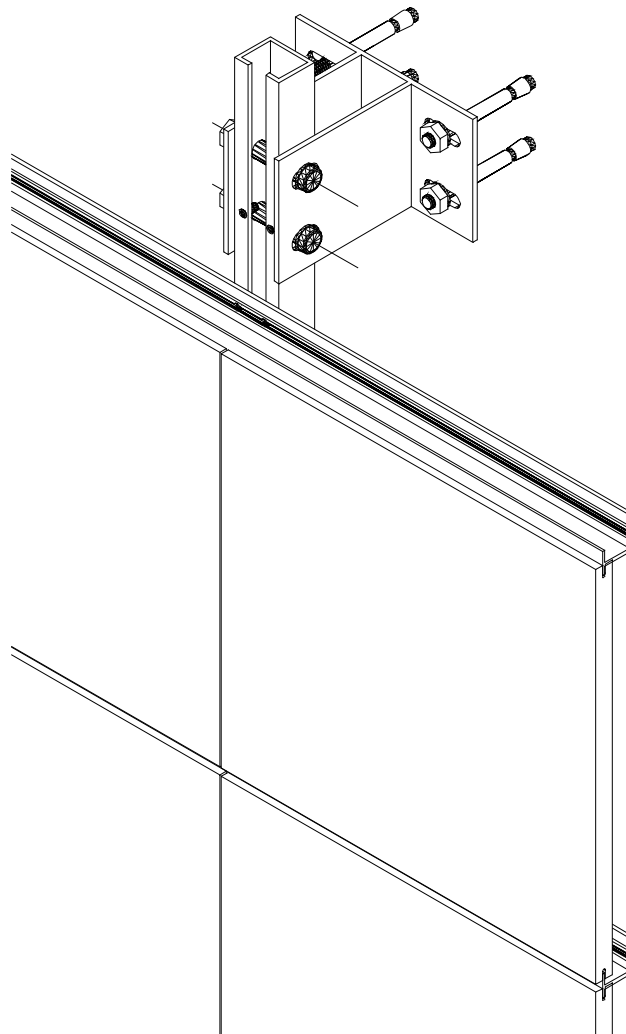

KERAMIČKA FASADA SA
NEVIDLJIVOM KOPČOM

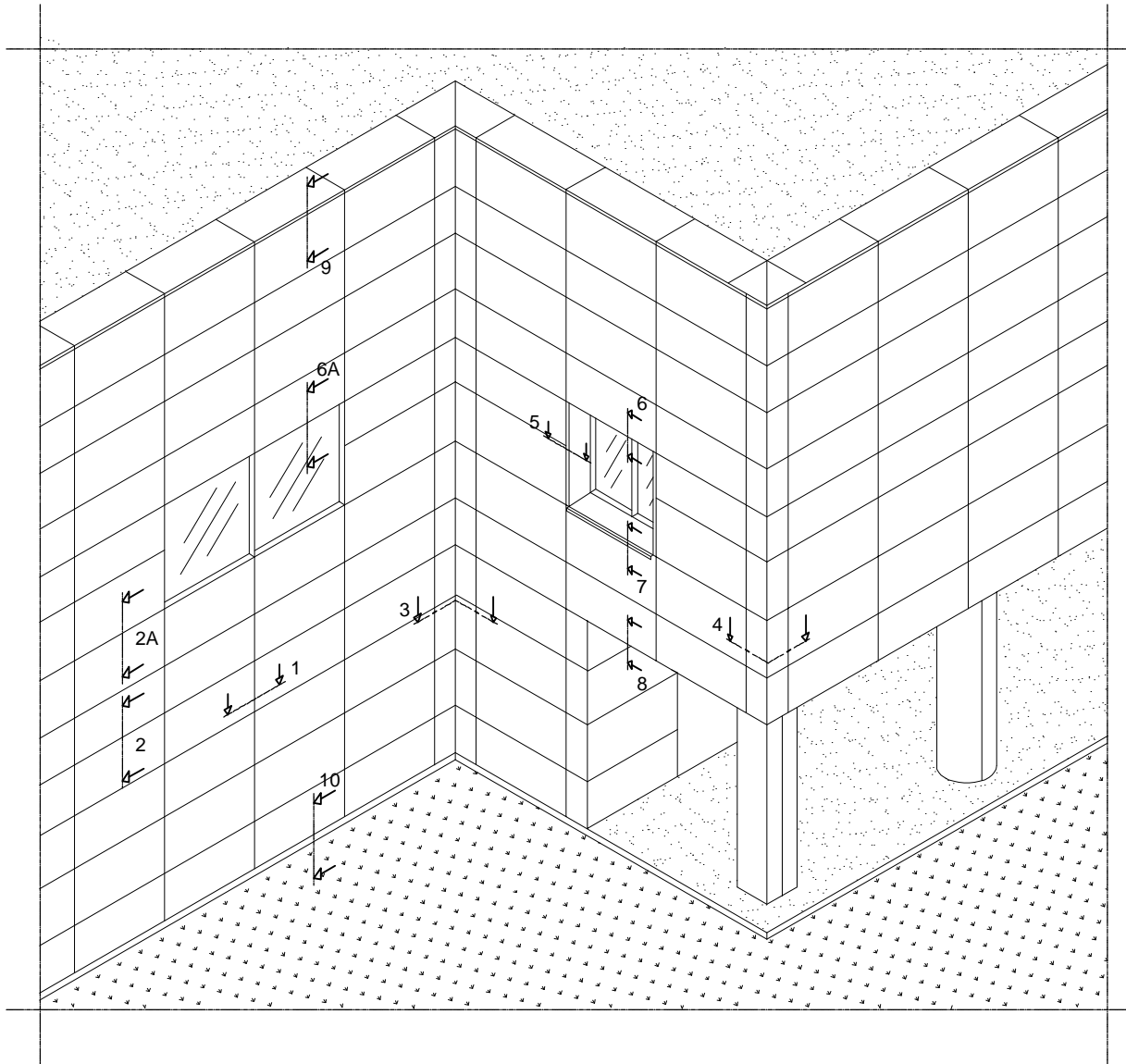

1

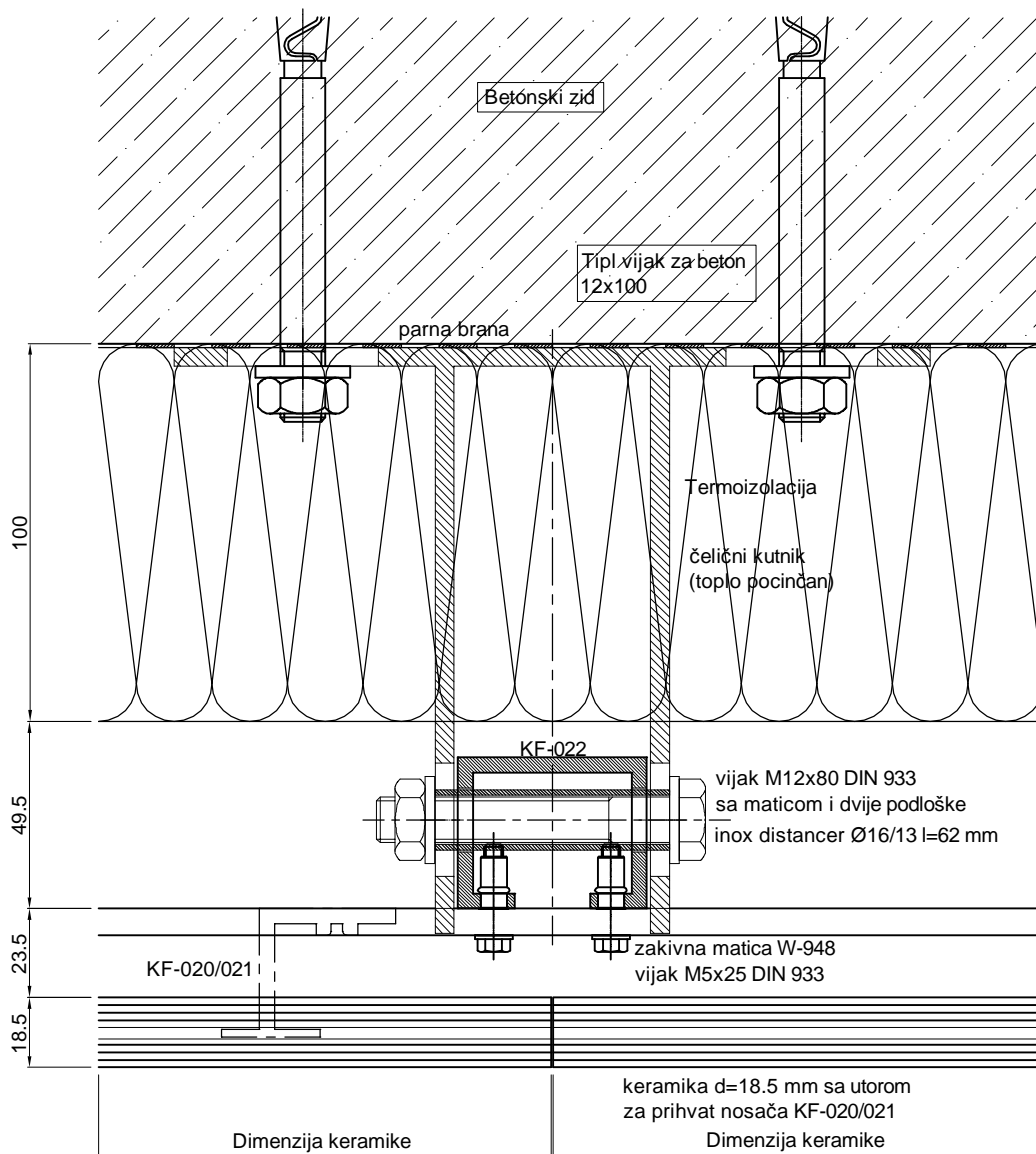

②

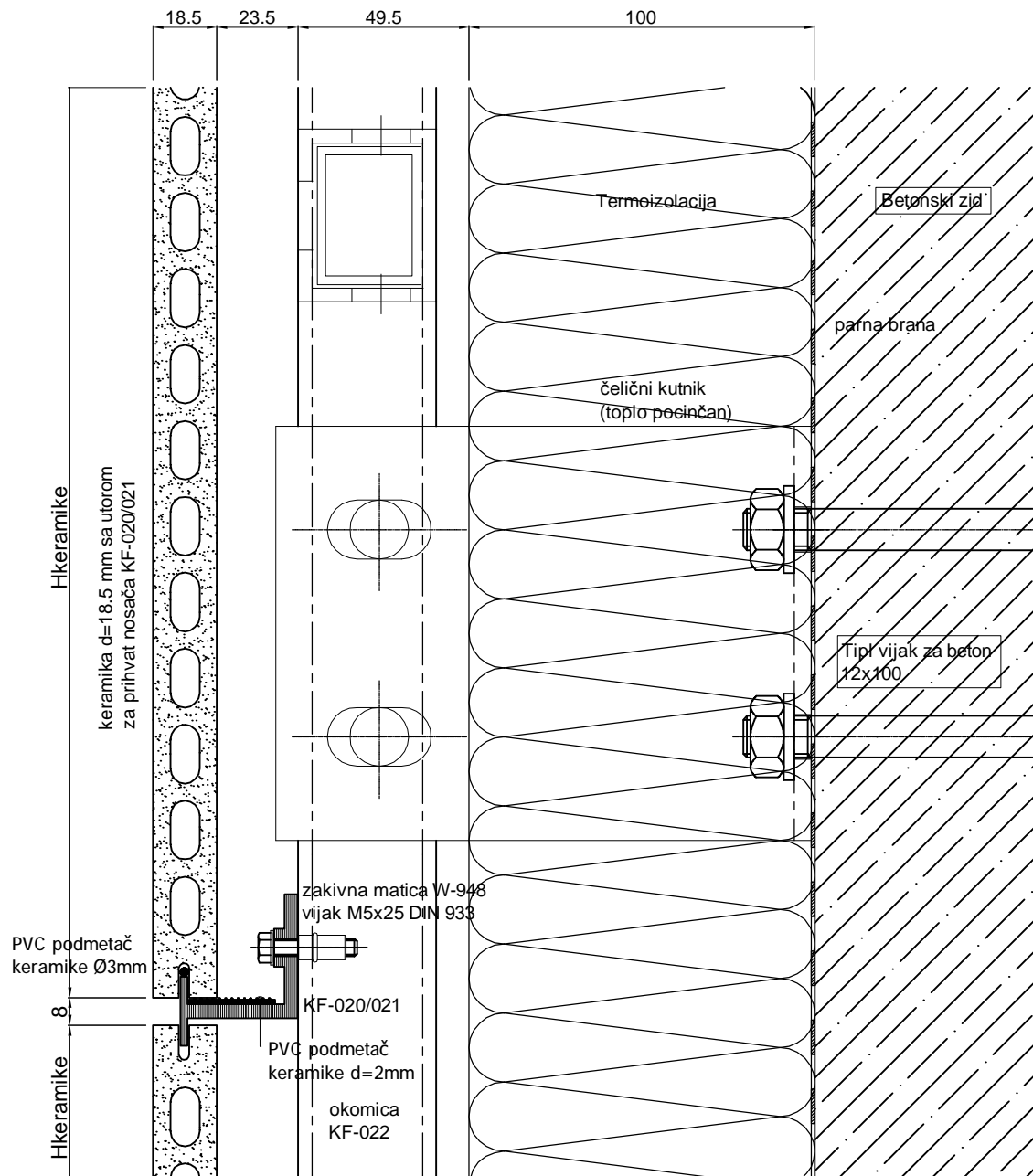

③

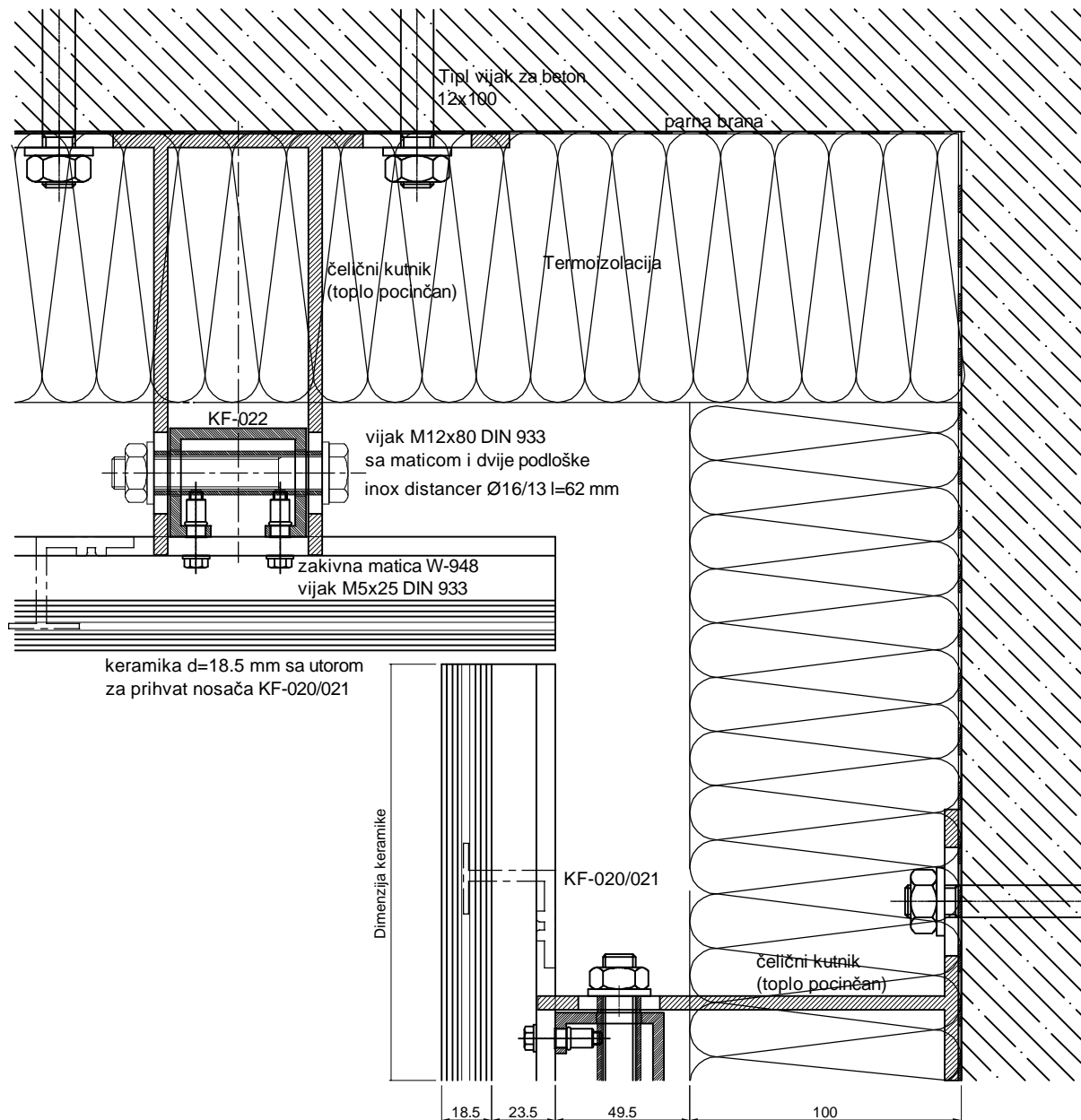

④

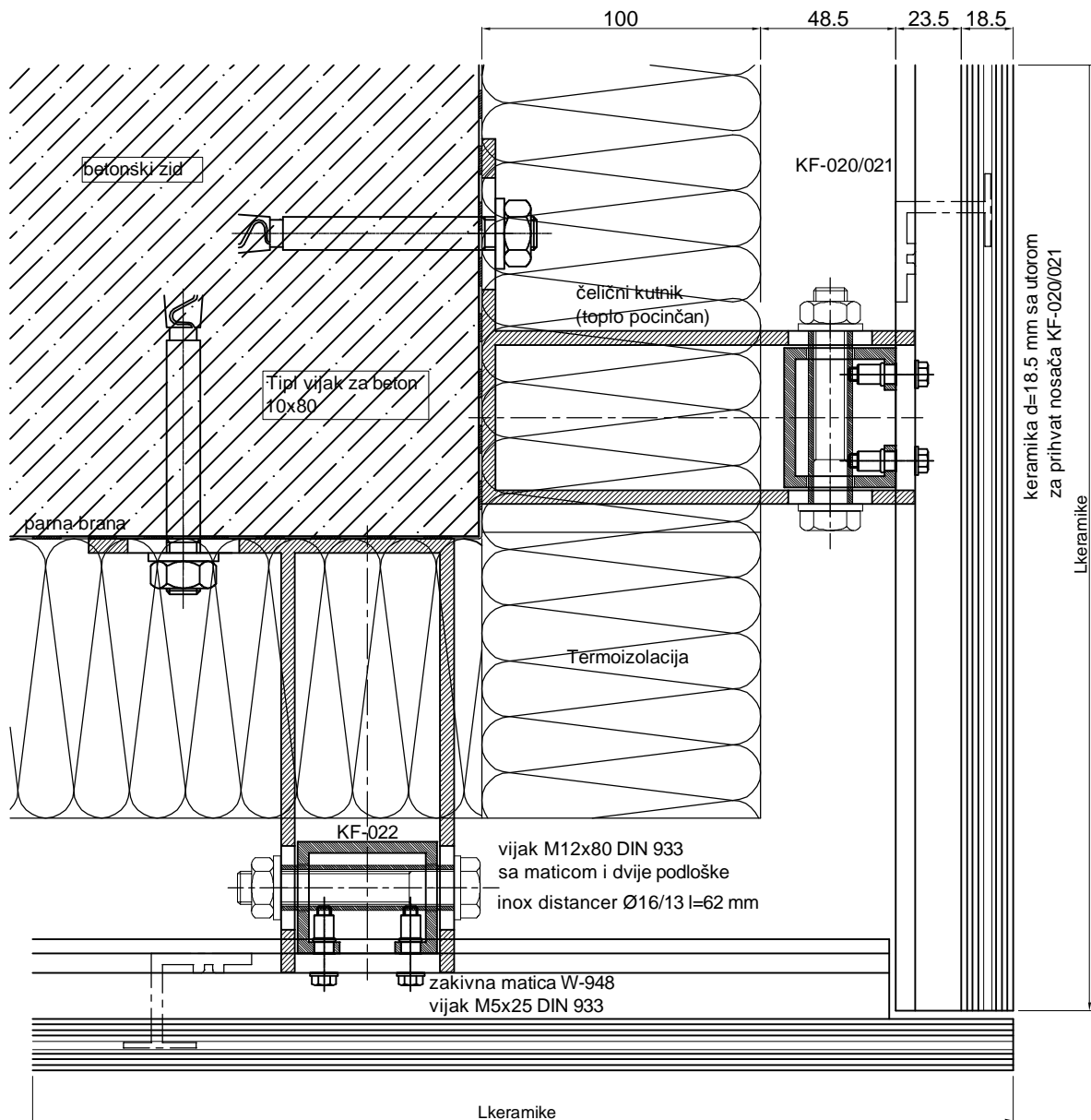

5

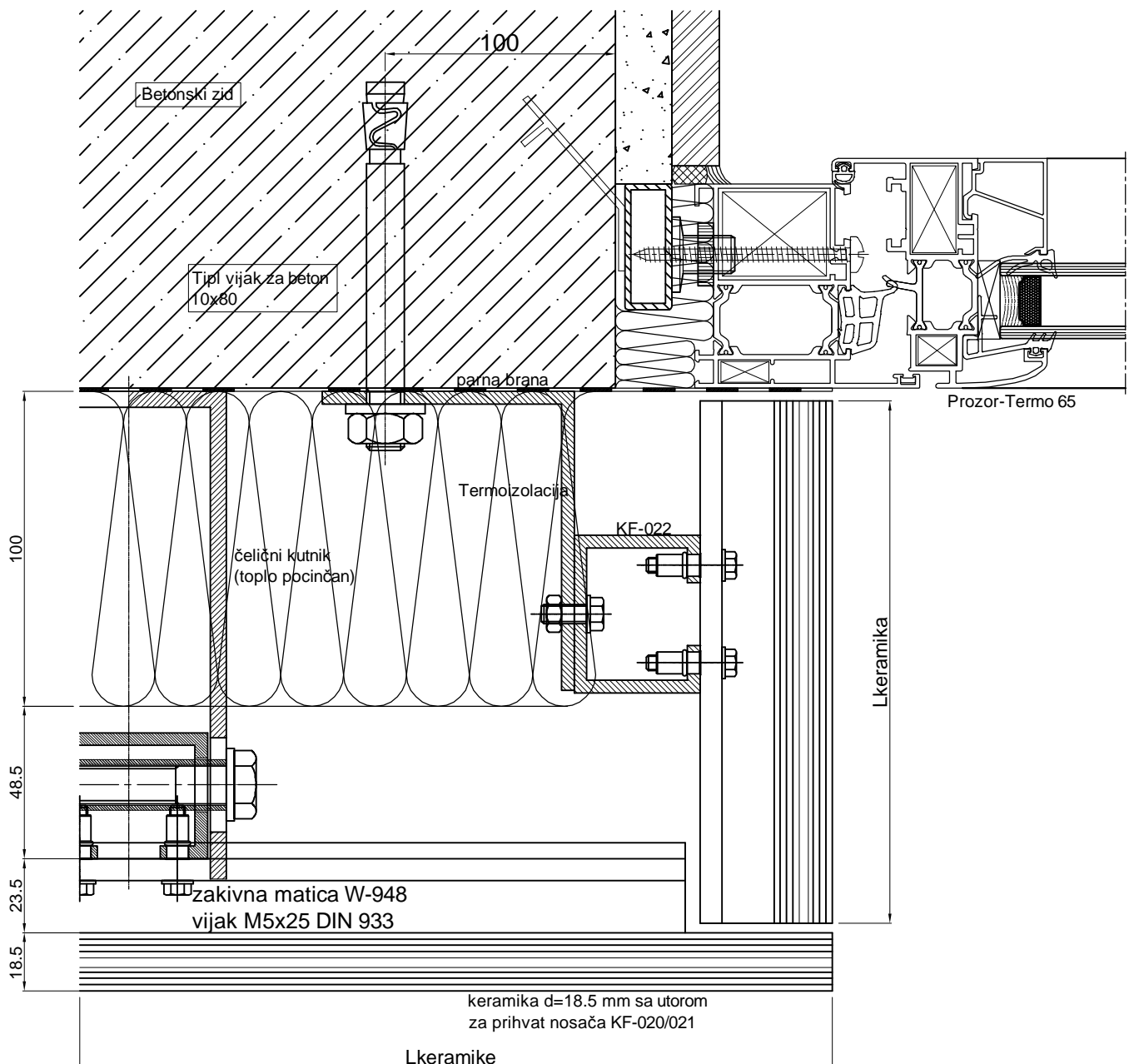

⑥

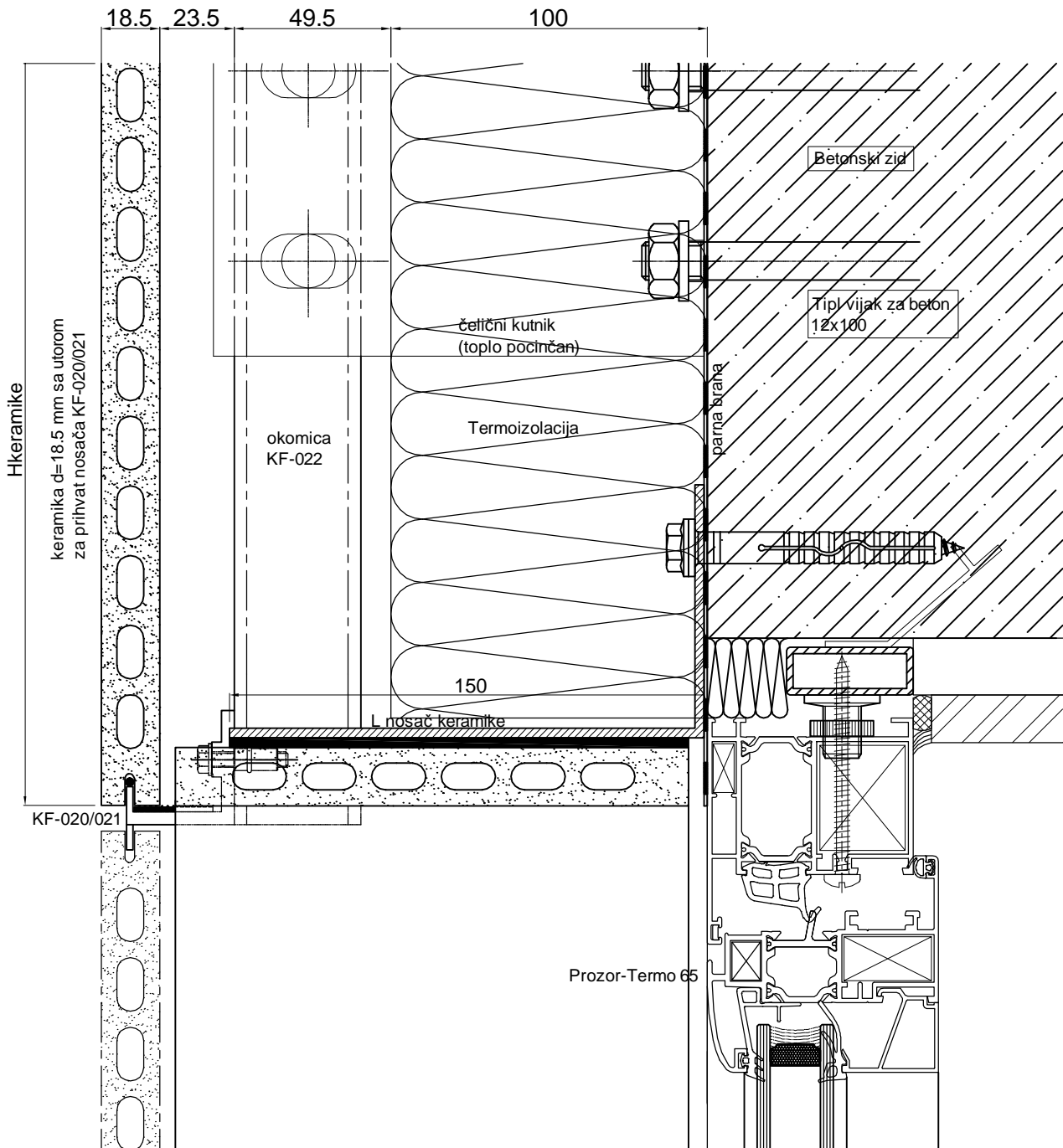

6A

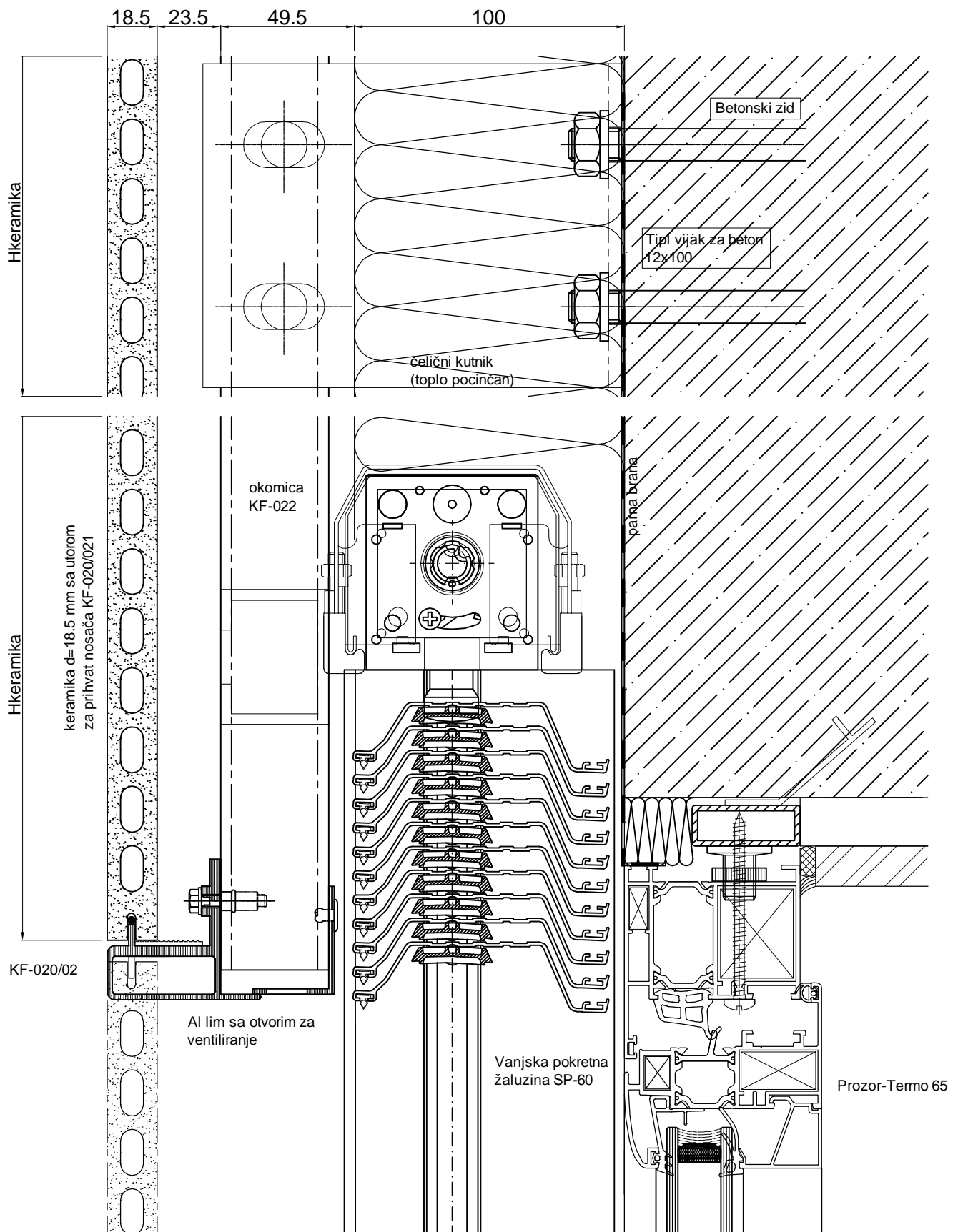

⑦

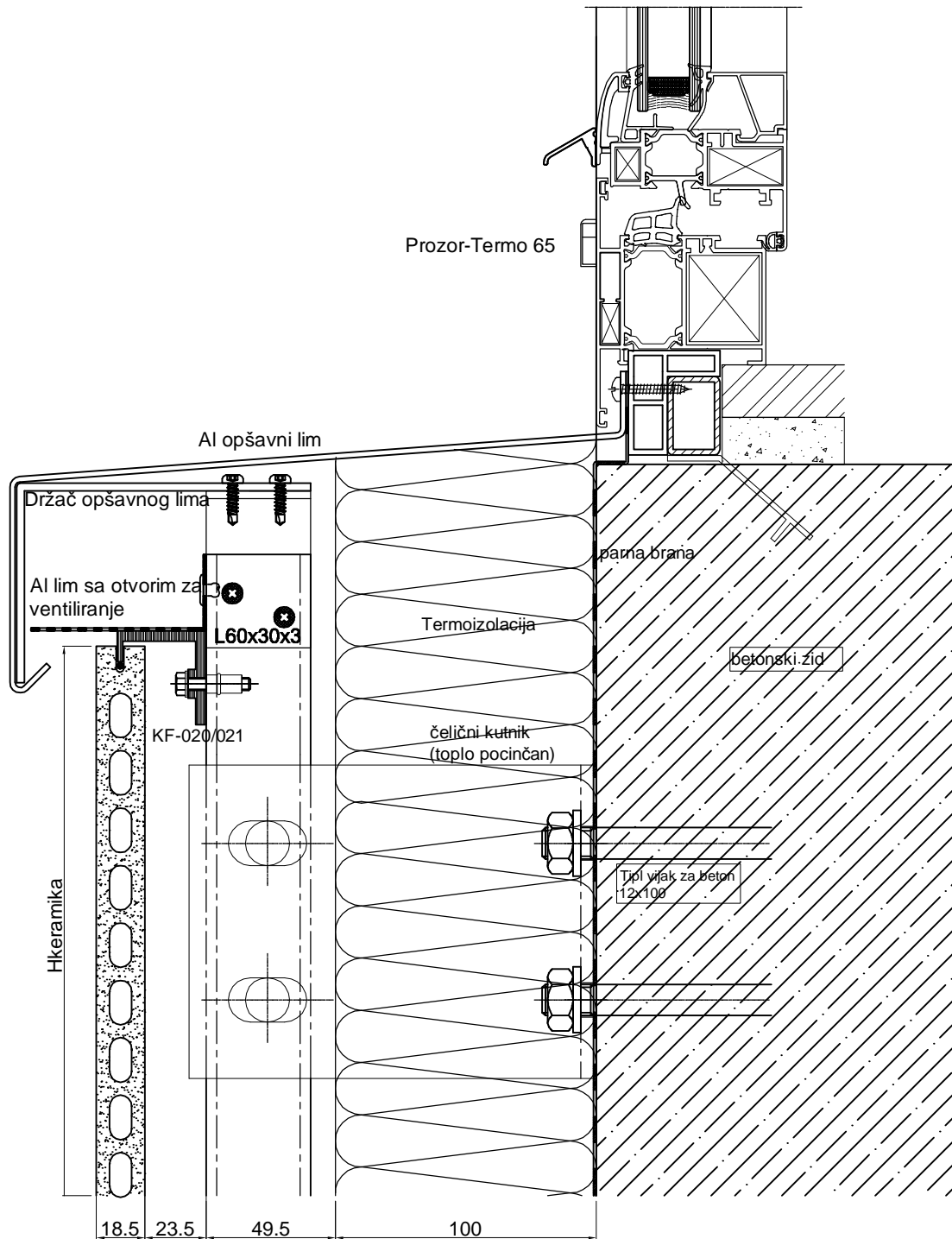

8

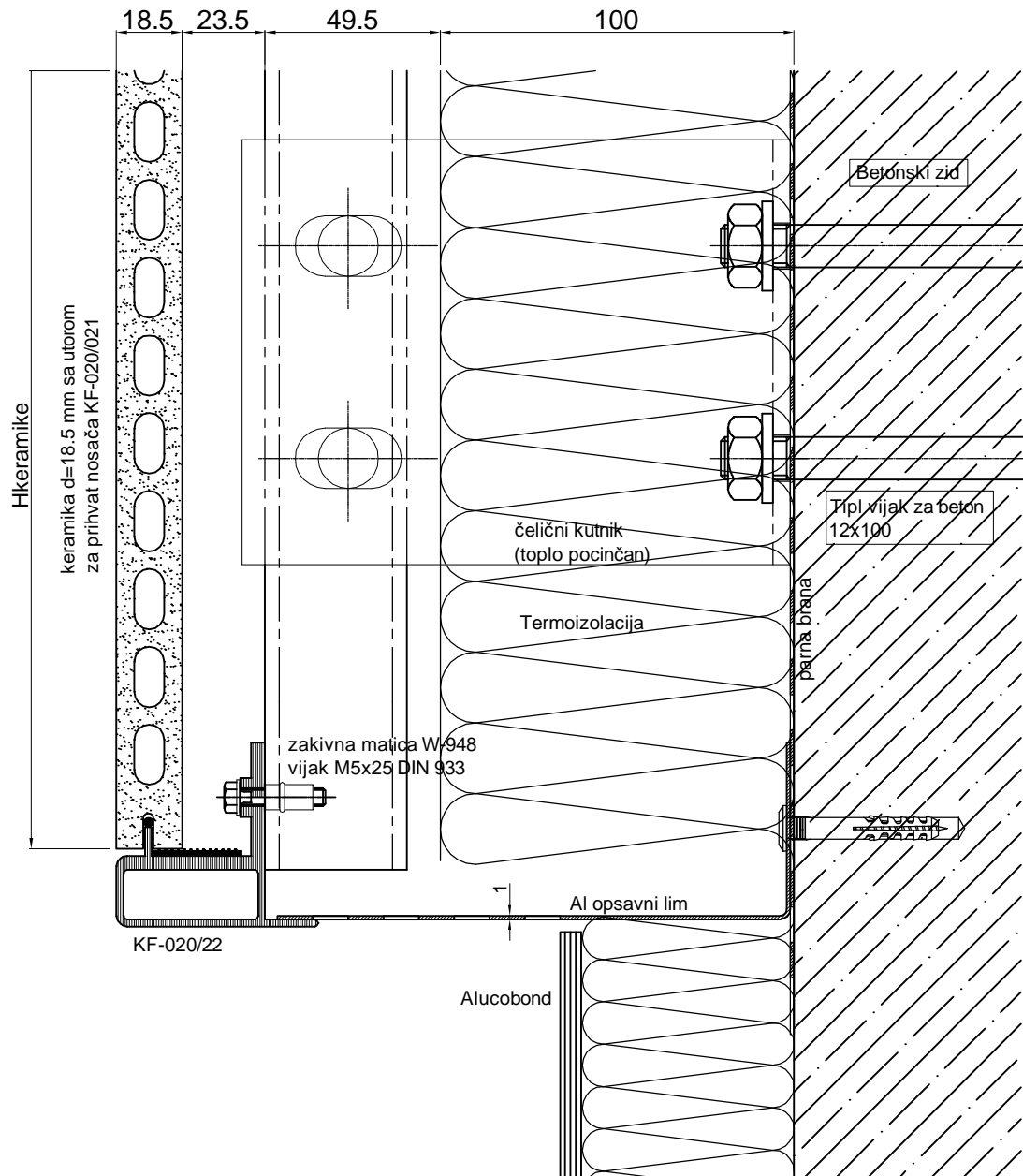

10

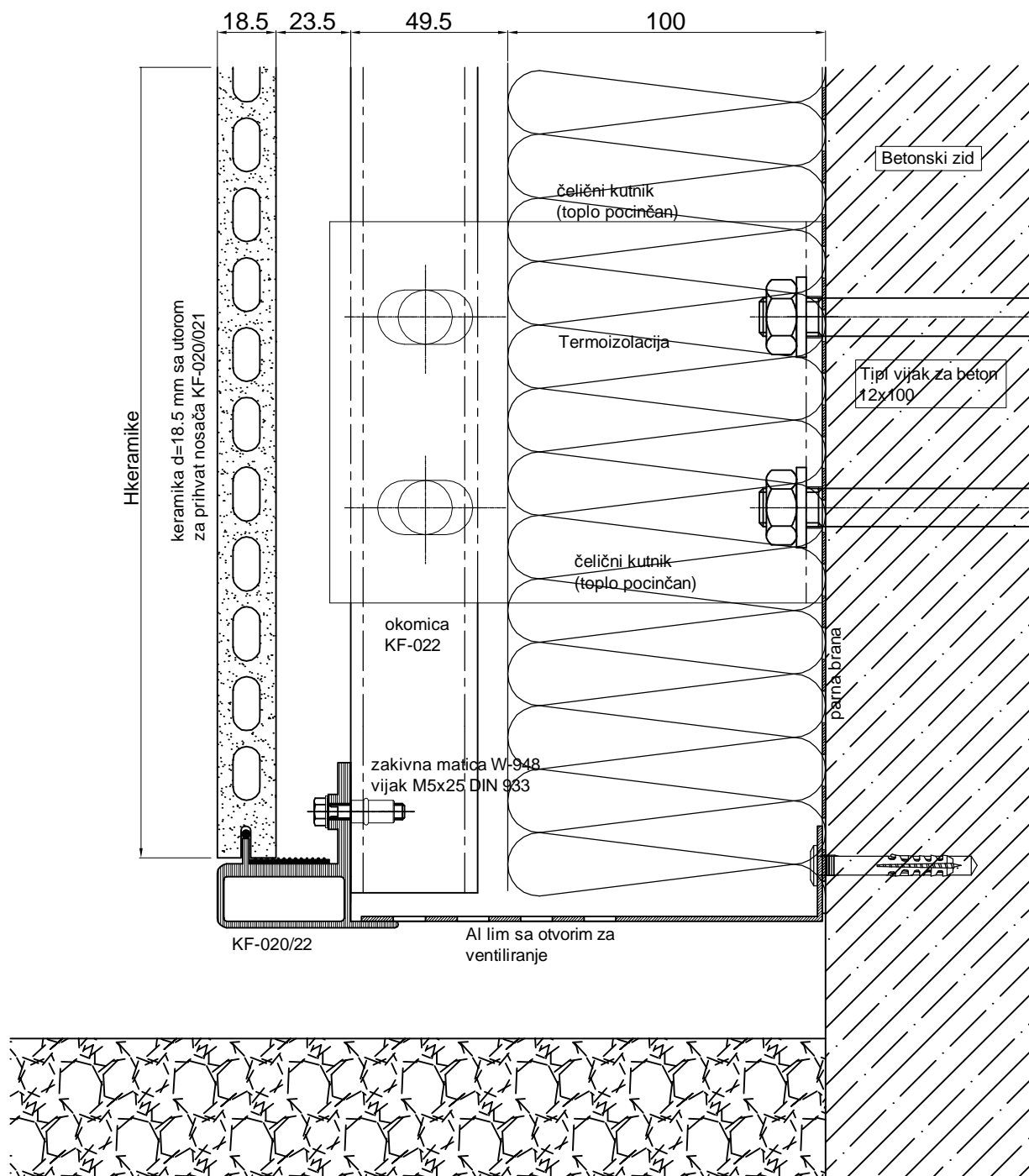

9

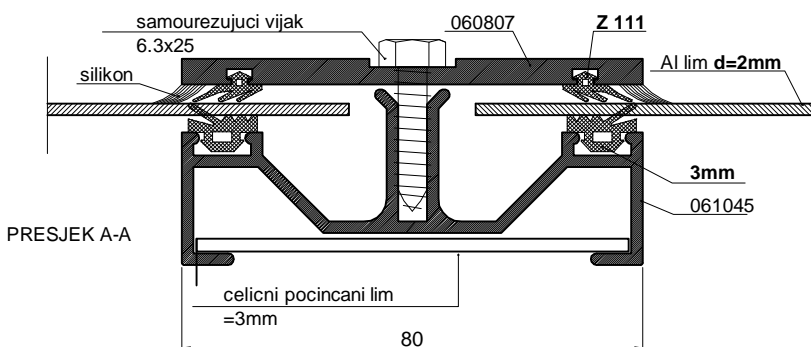
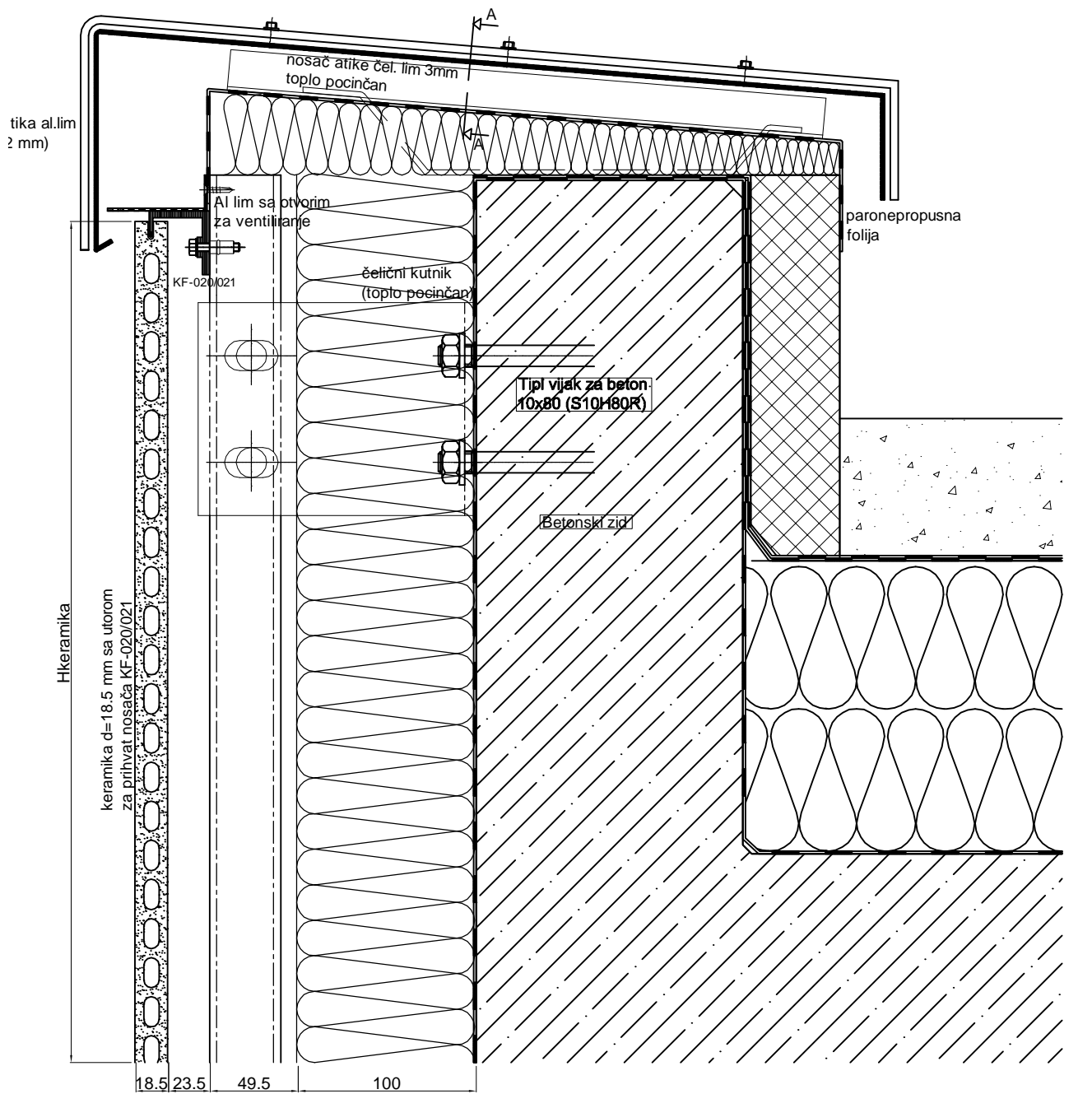

KERAMIČKA FASADA

-obrade i montaža-

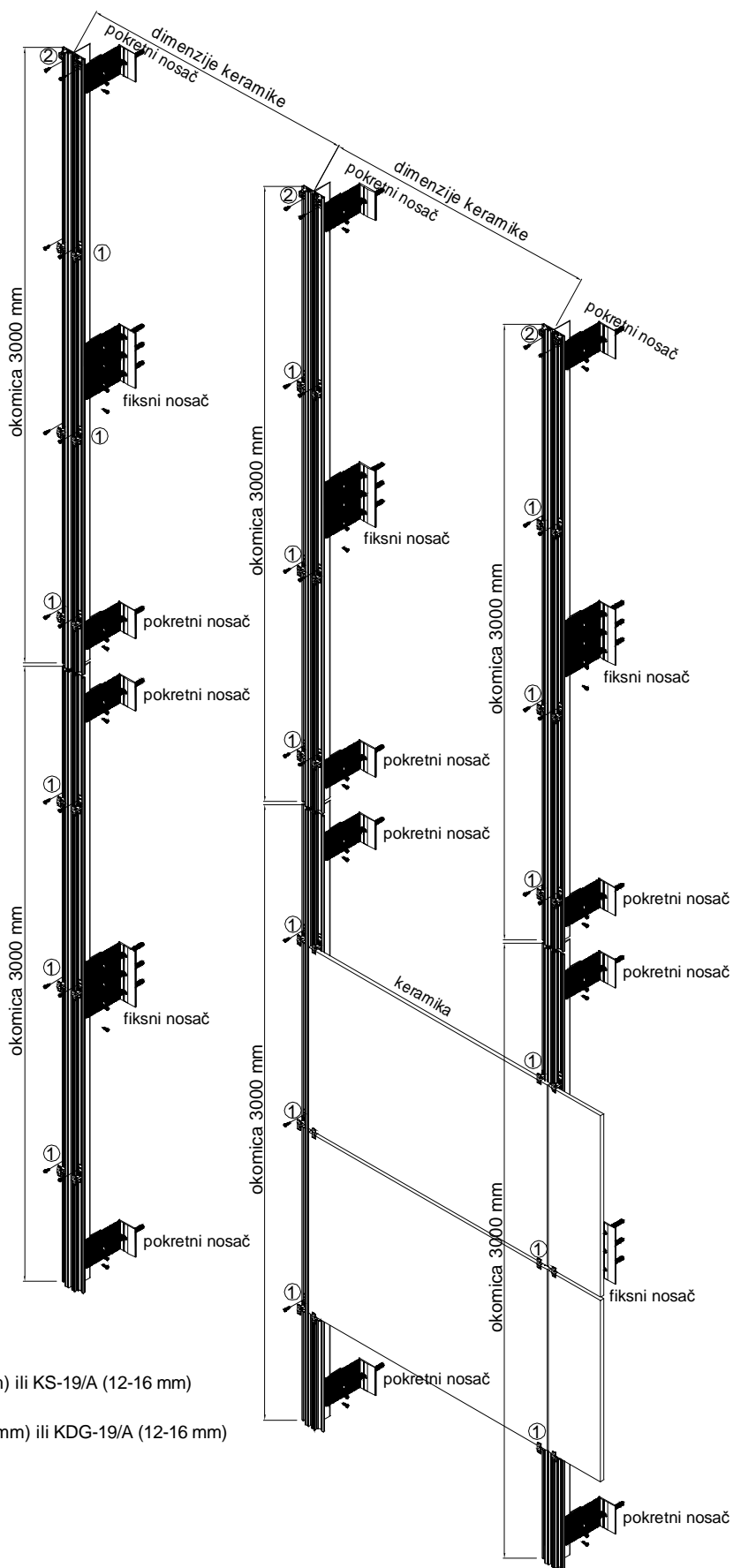

① srednja kopča KS-19 (8-12 mm) ili KS-19/A (12-16 mm)

② završna kopča KDG-19 (8-12 mm) ili KDG-19/A (12-16 mm)

spoj dviju okomica

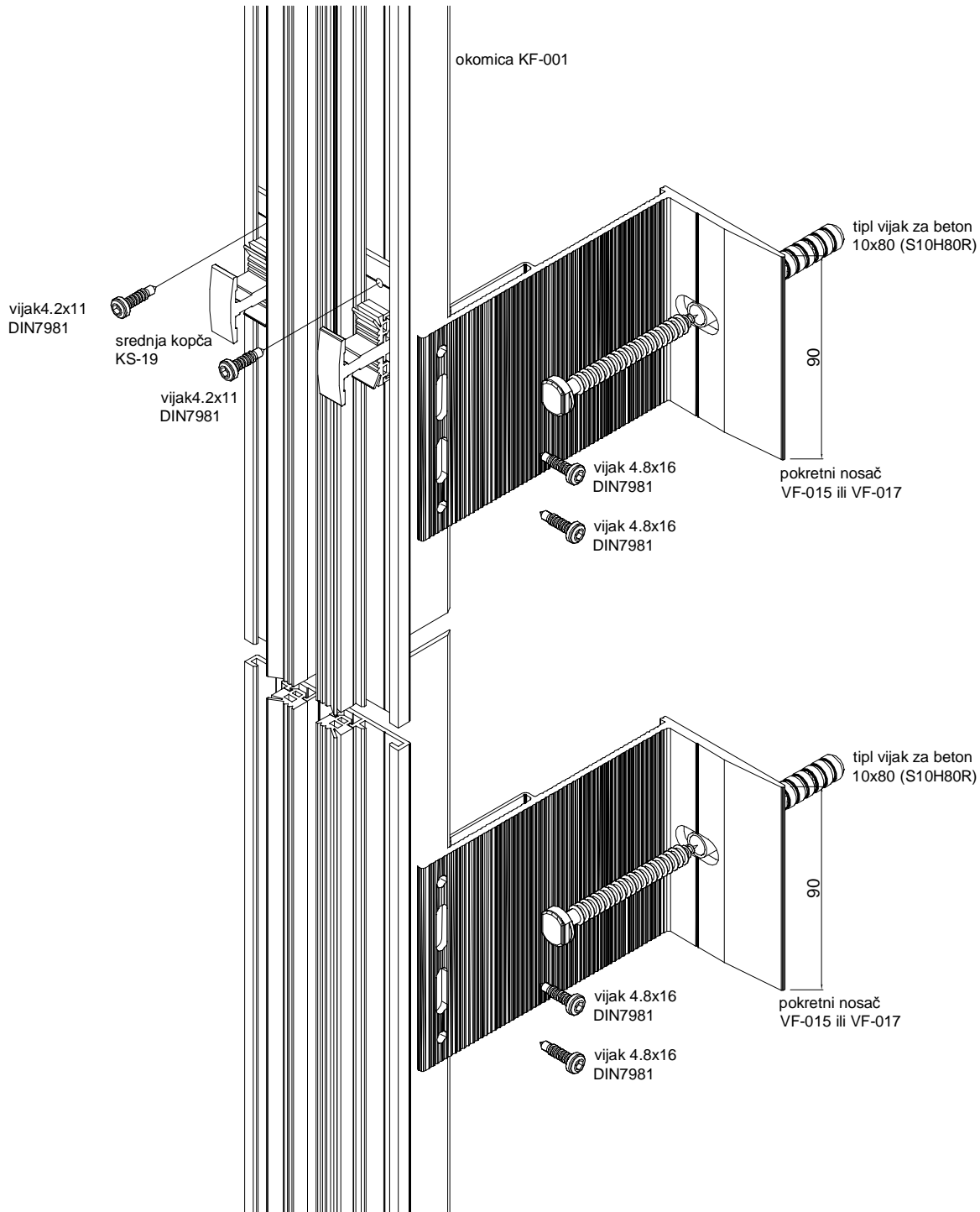

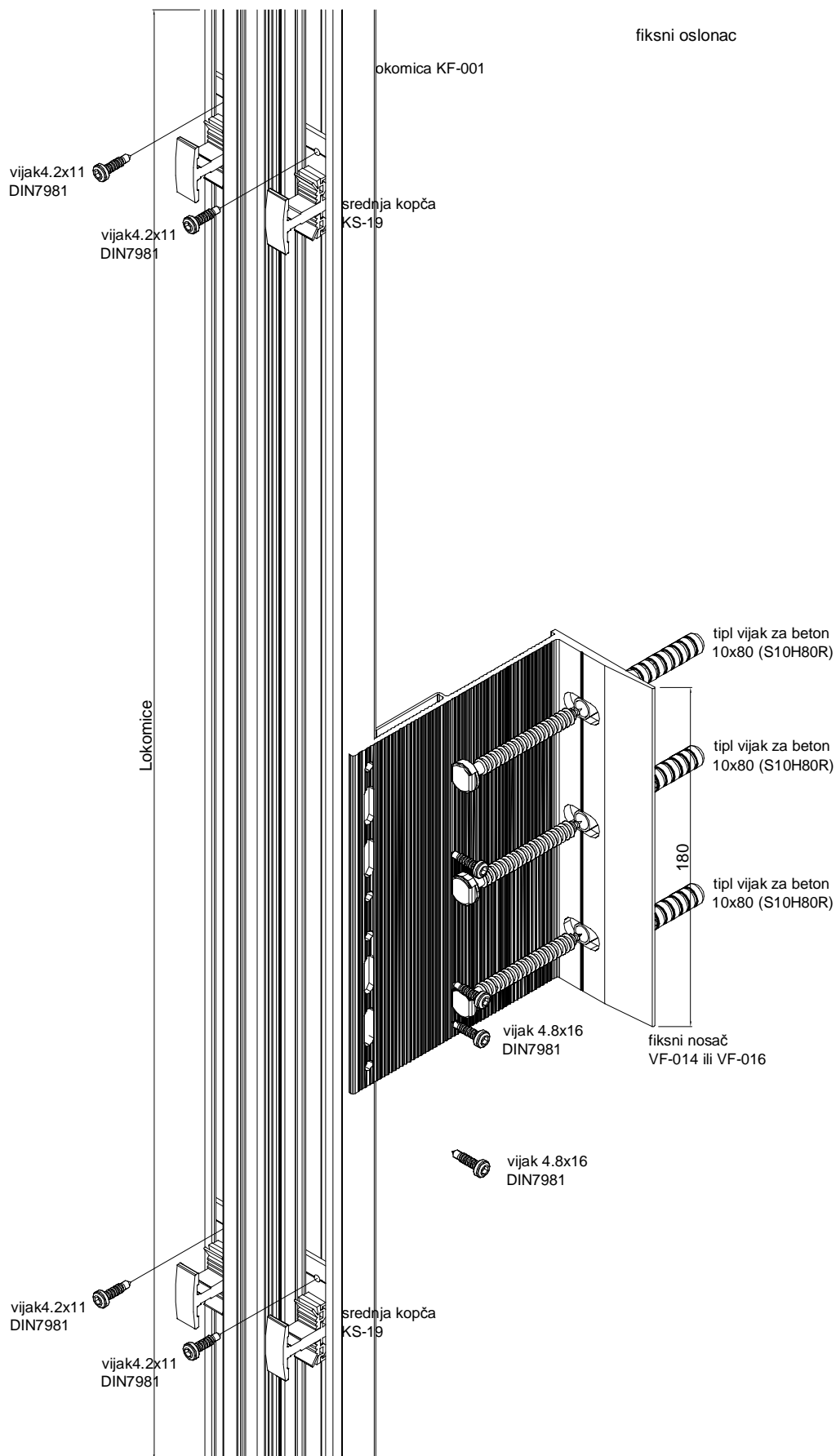

krajnja kopča

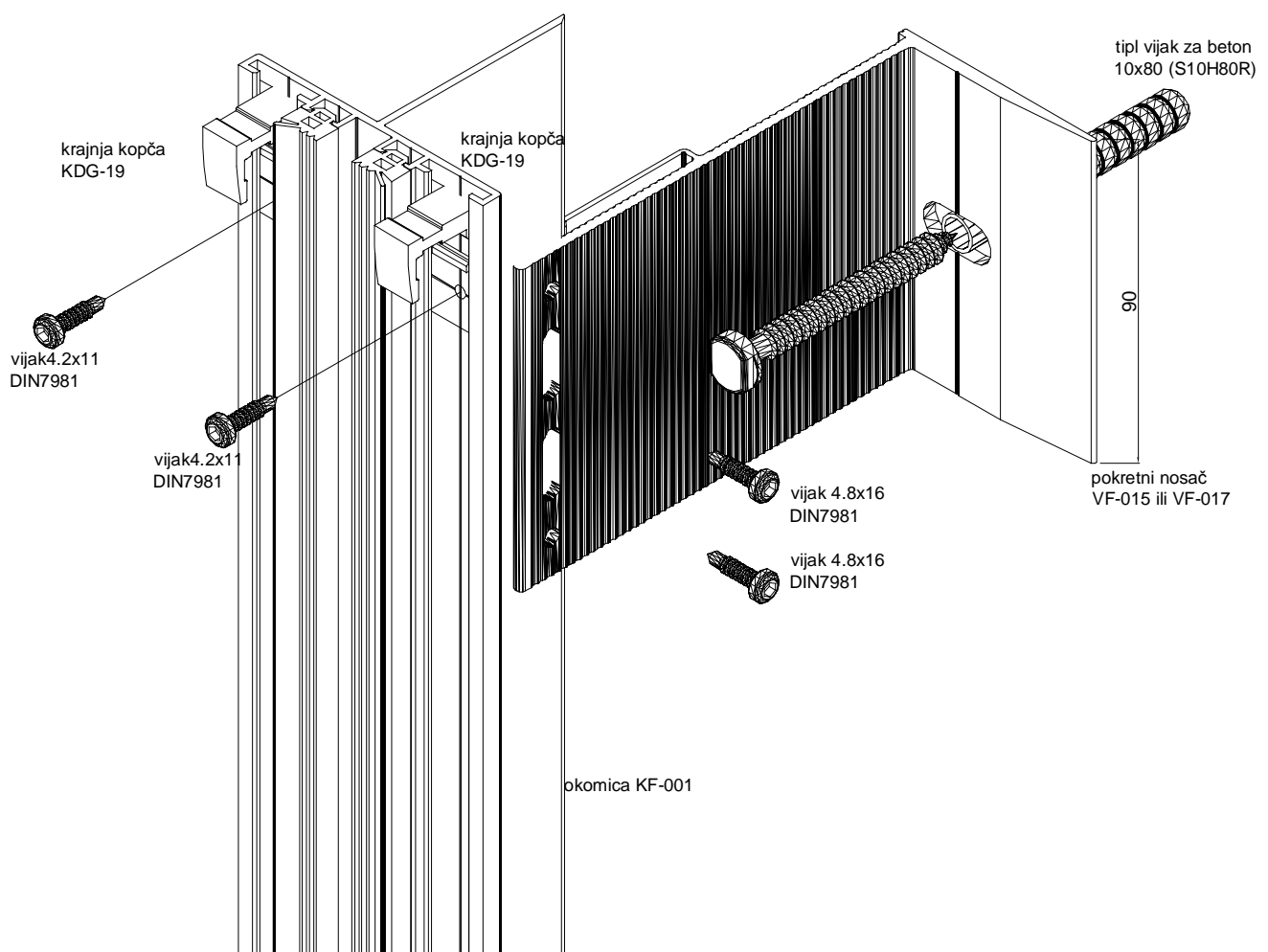

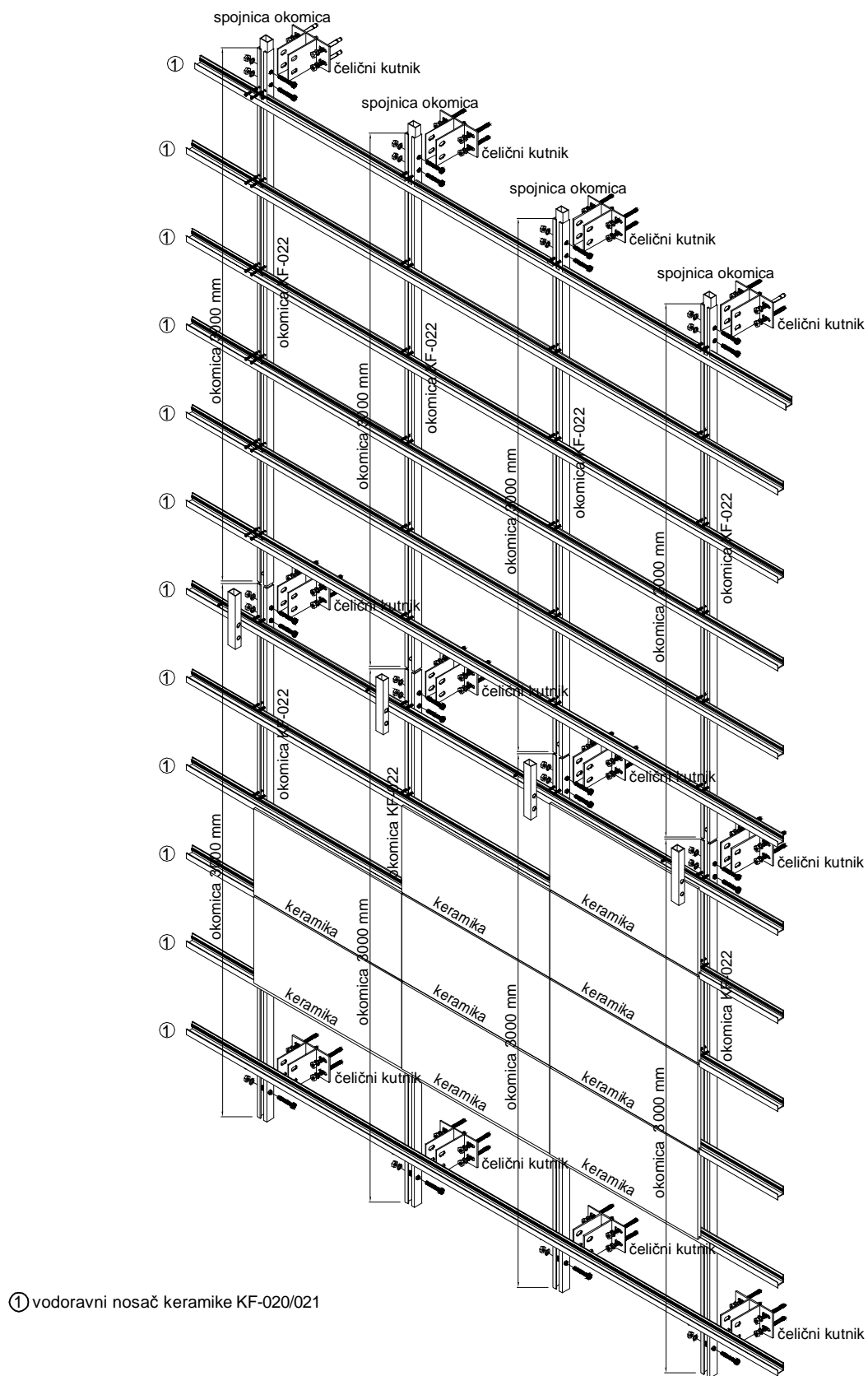

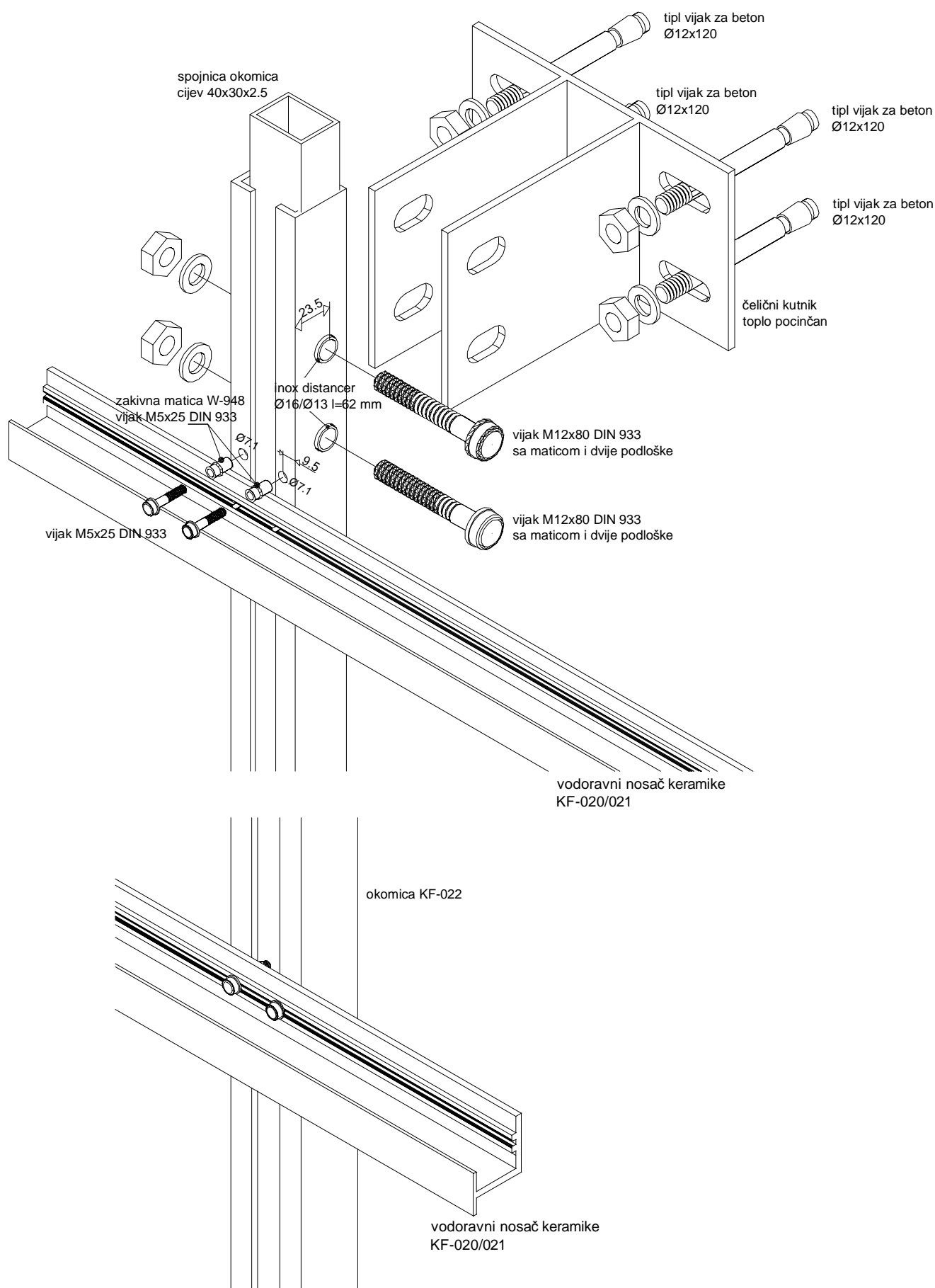

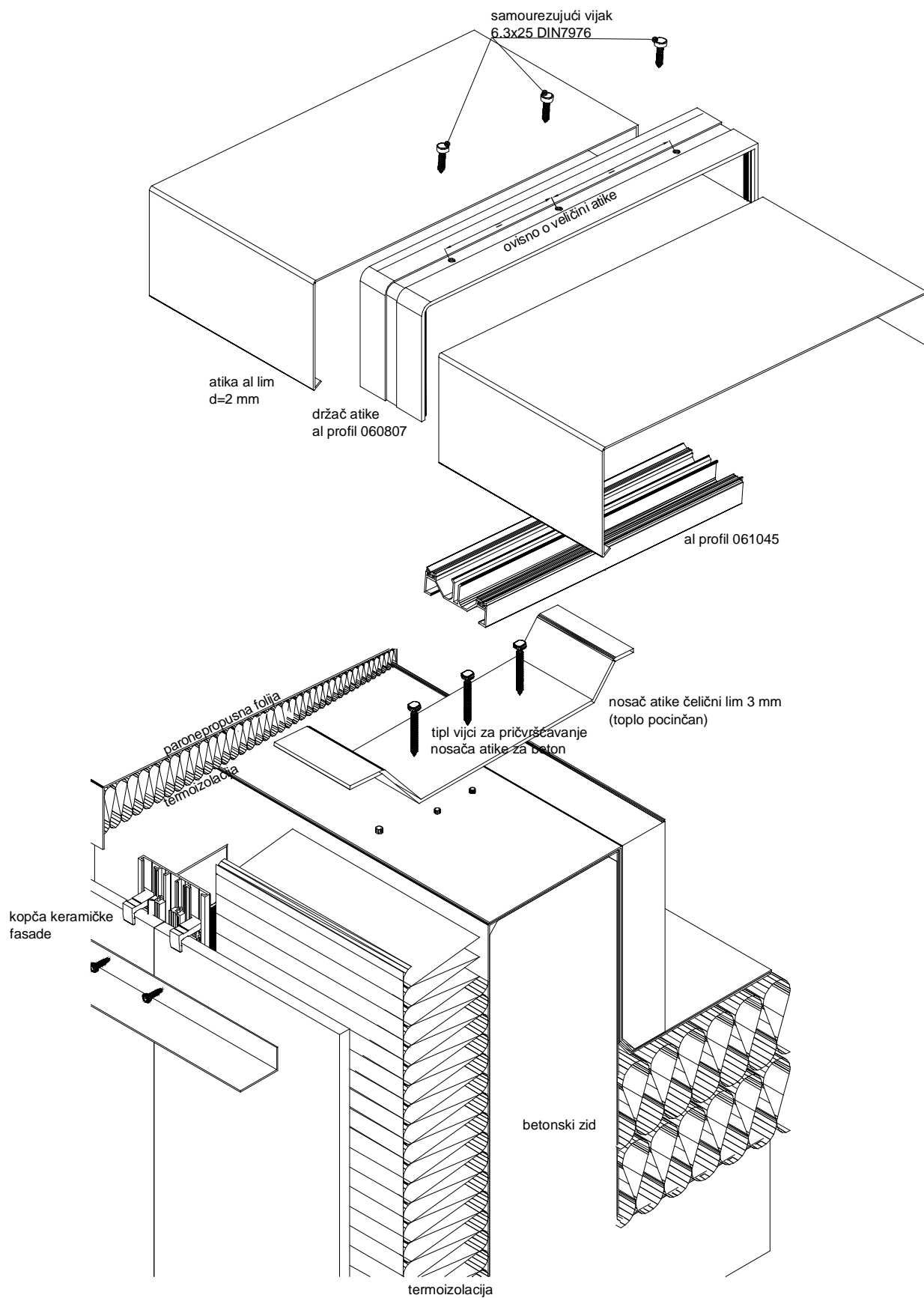

VENTILIRAJUĆE
FASADNE OBLOGE

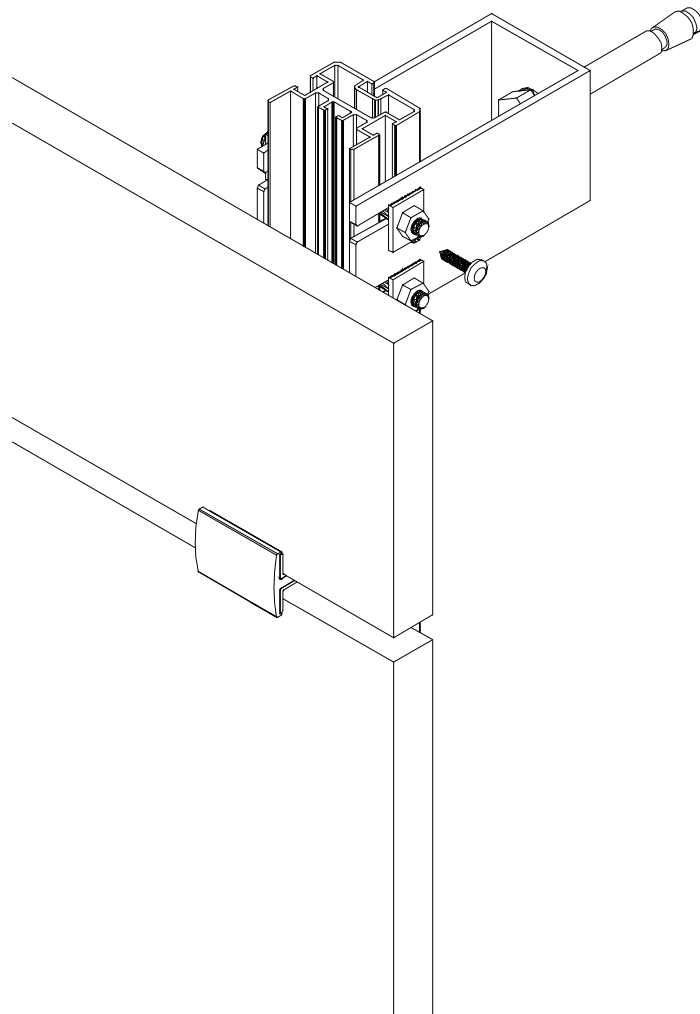

KAMENA FASADA SA
VIDLJIVIM KOPČAMA

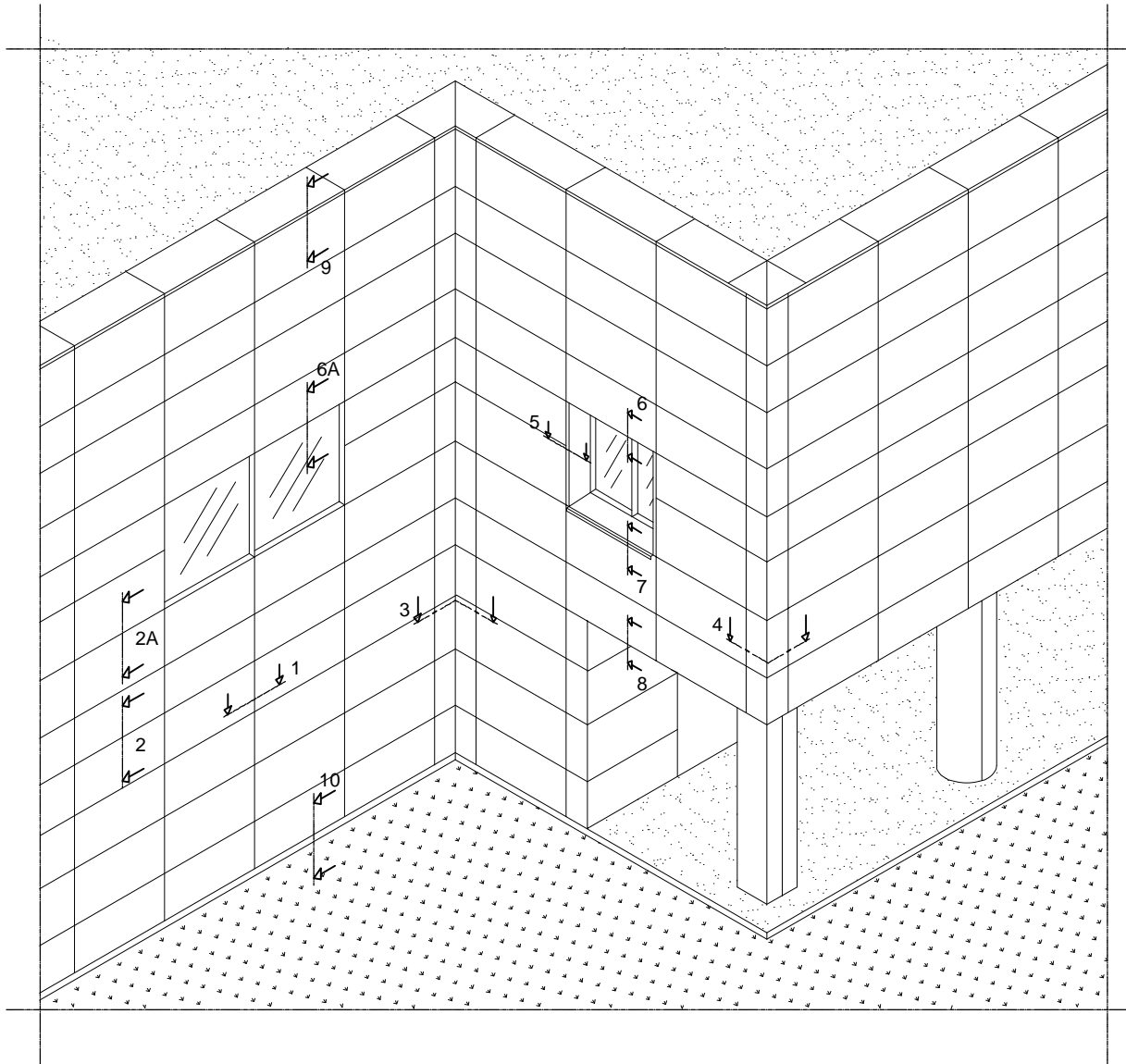

①

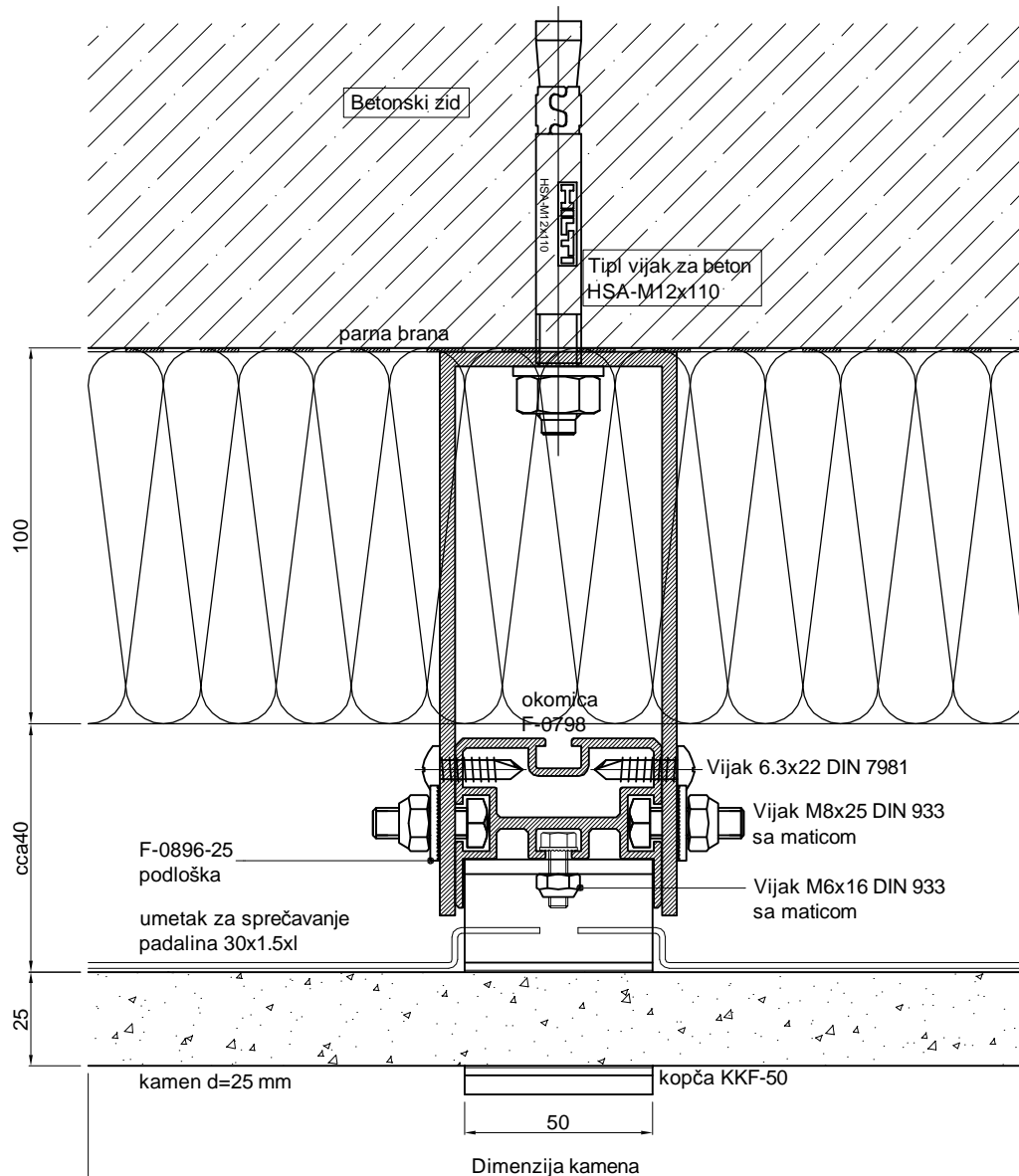

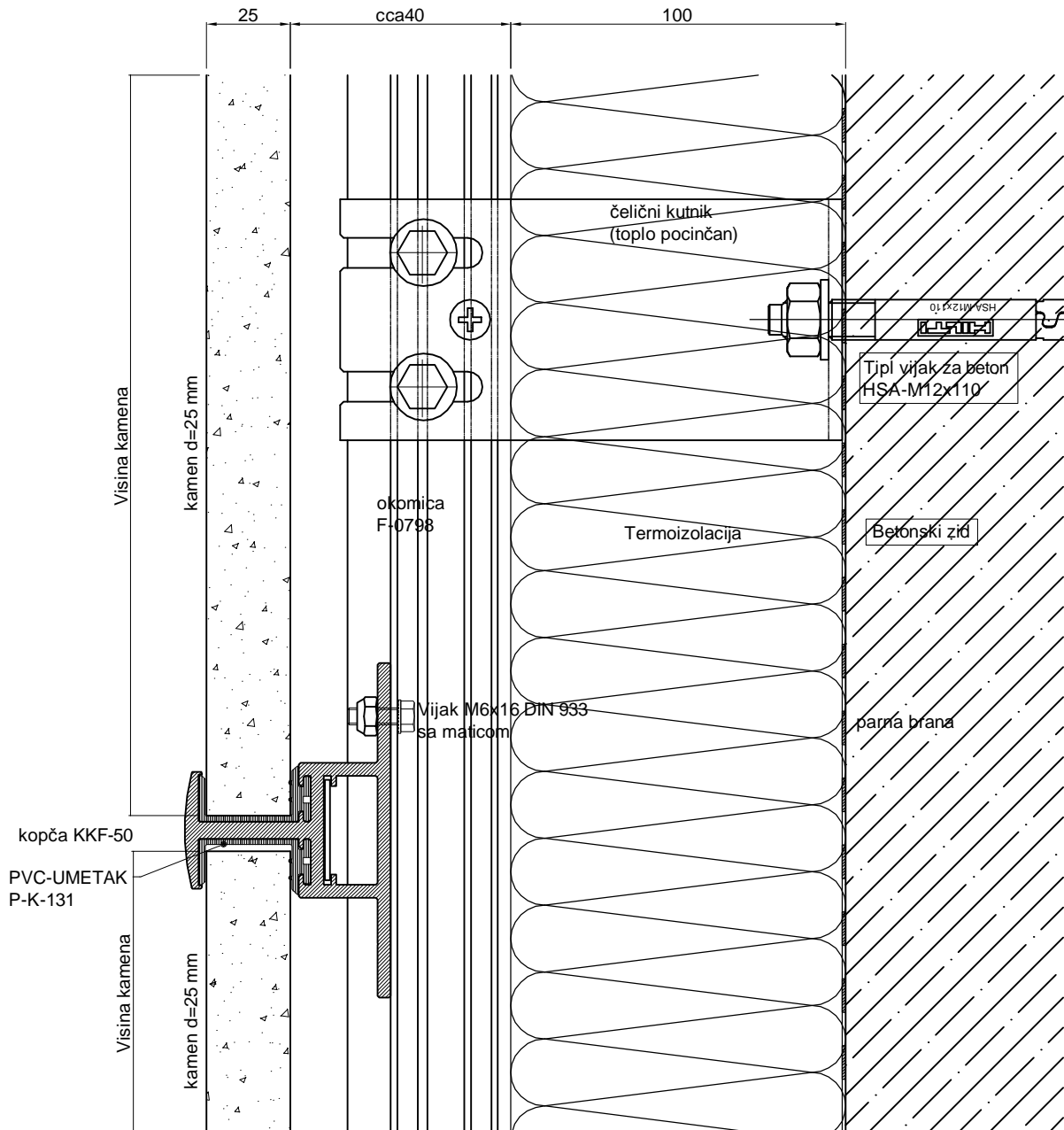

③

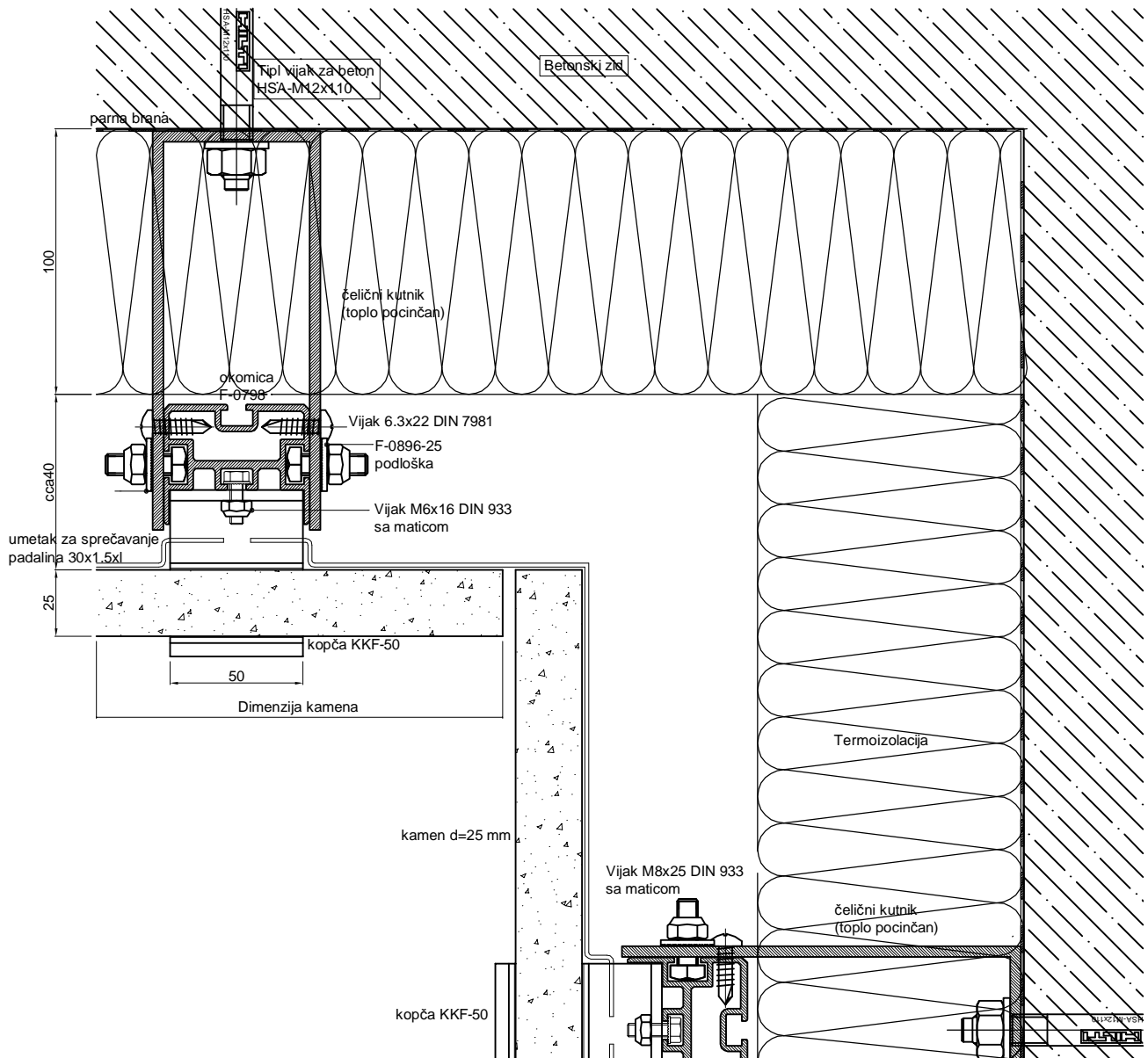

④

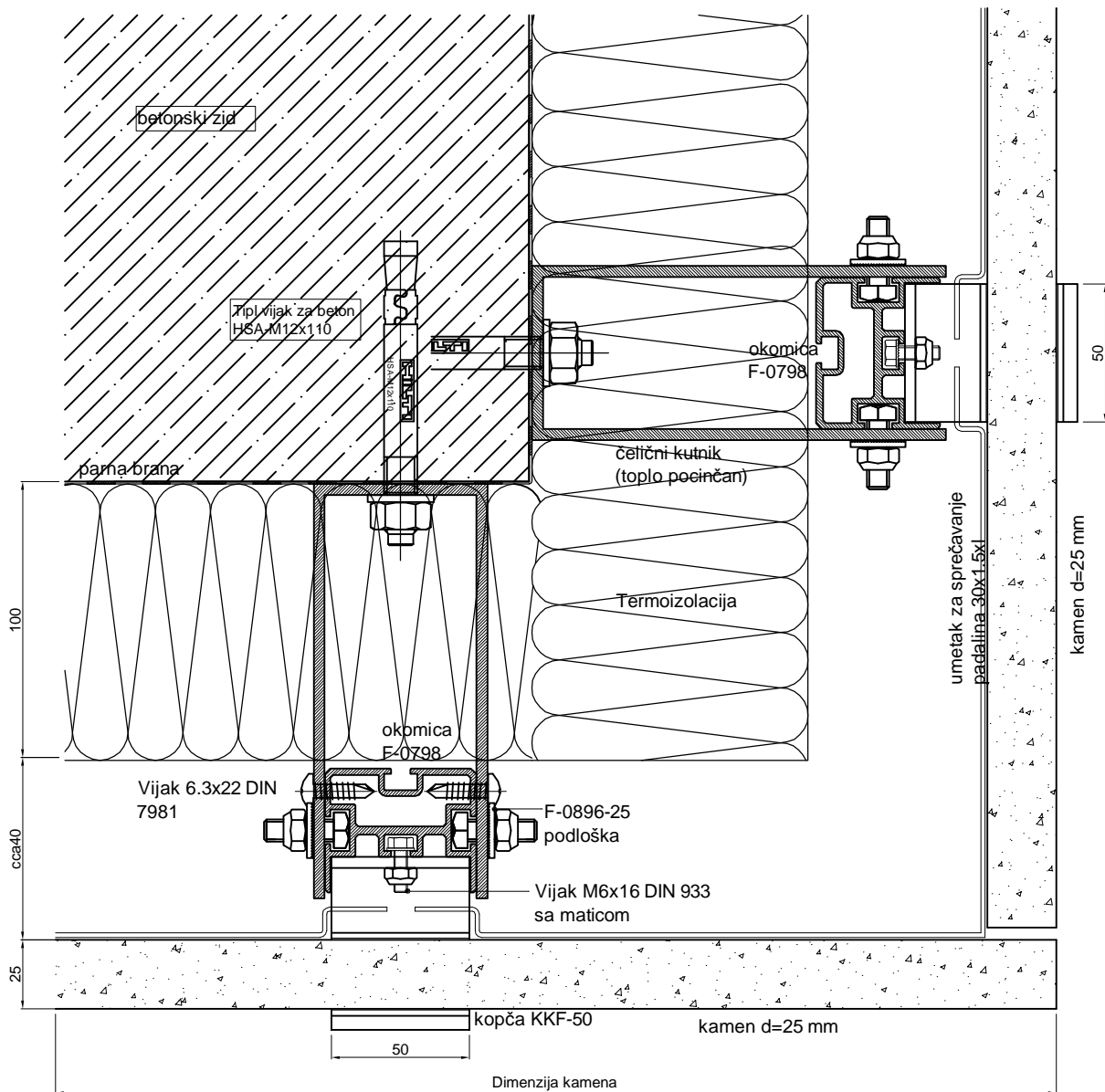

5

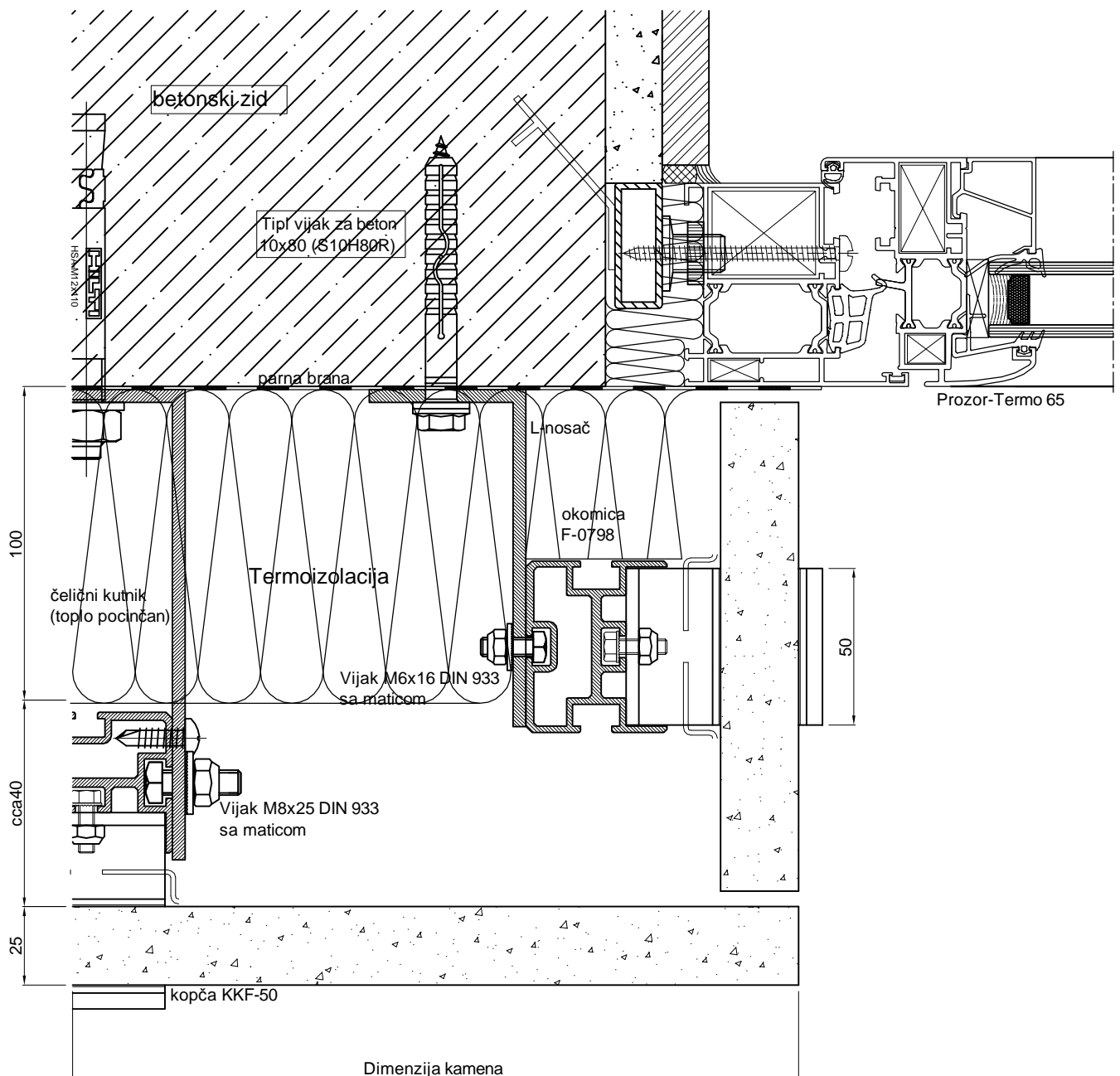

⑥

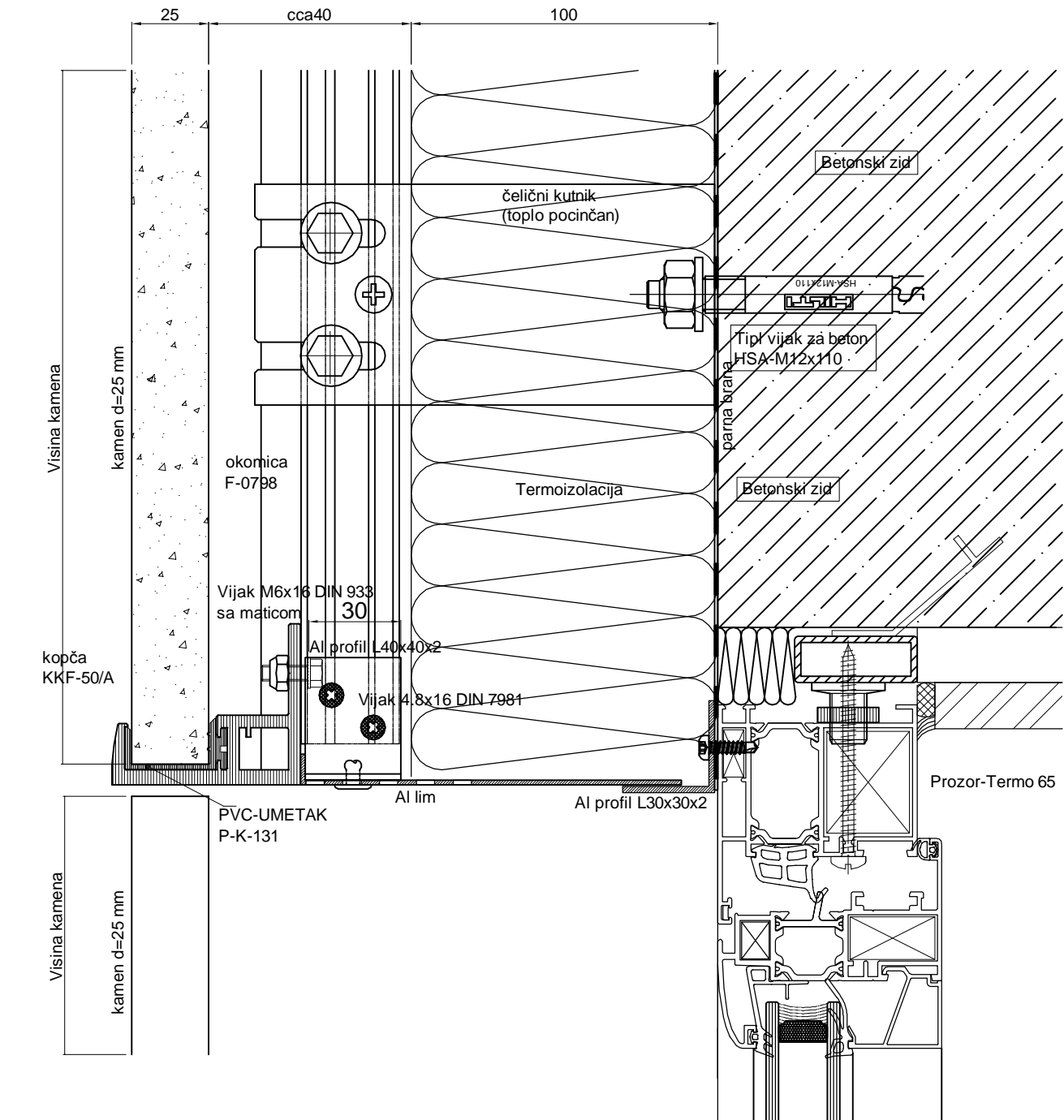

6A

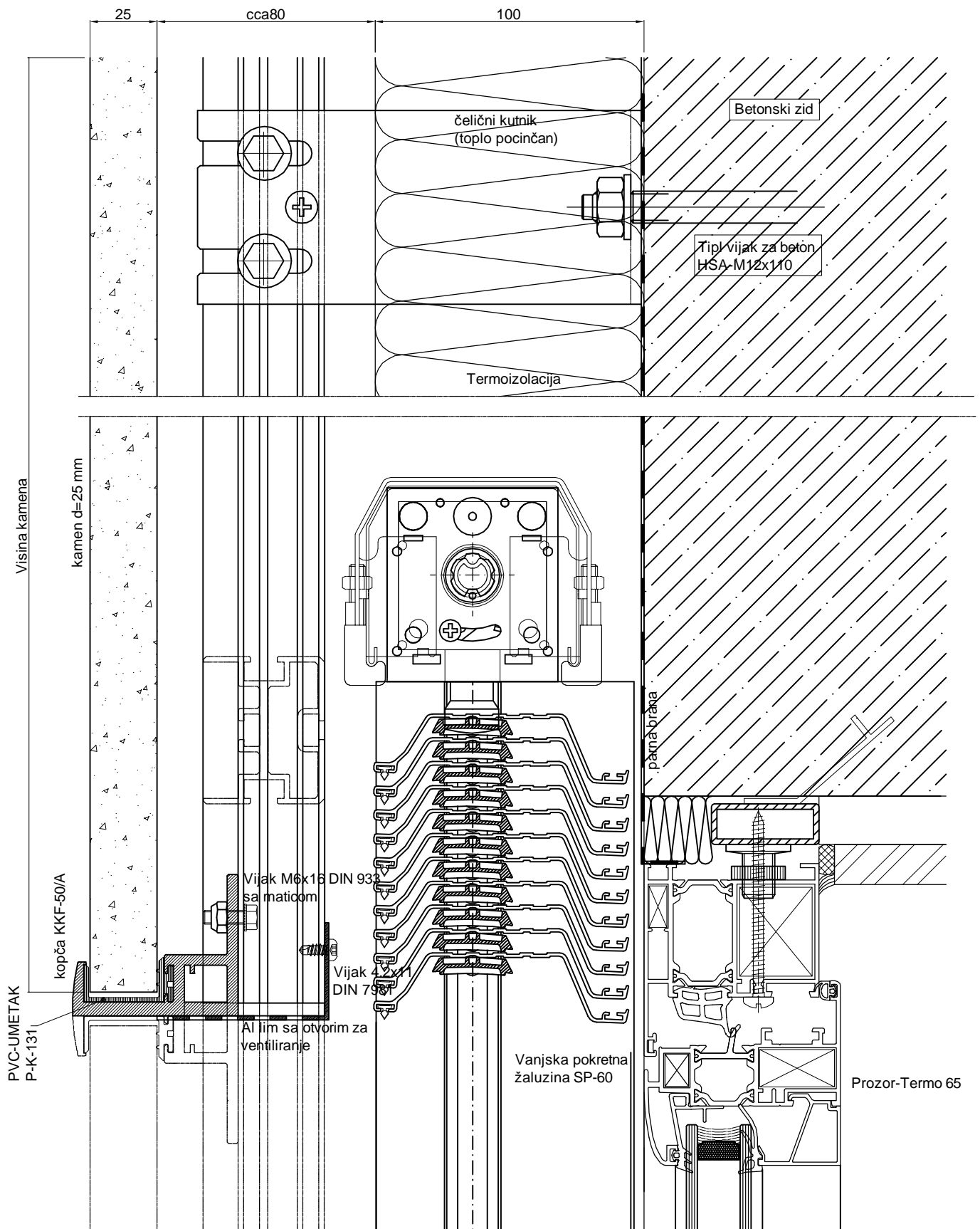

7

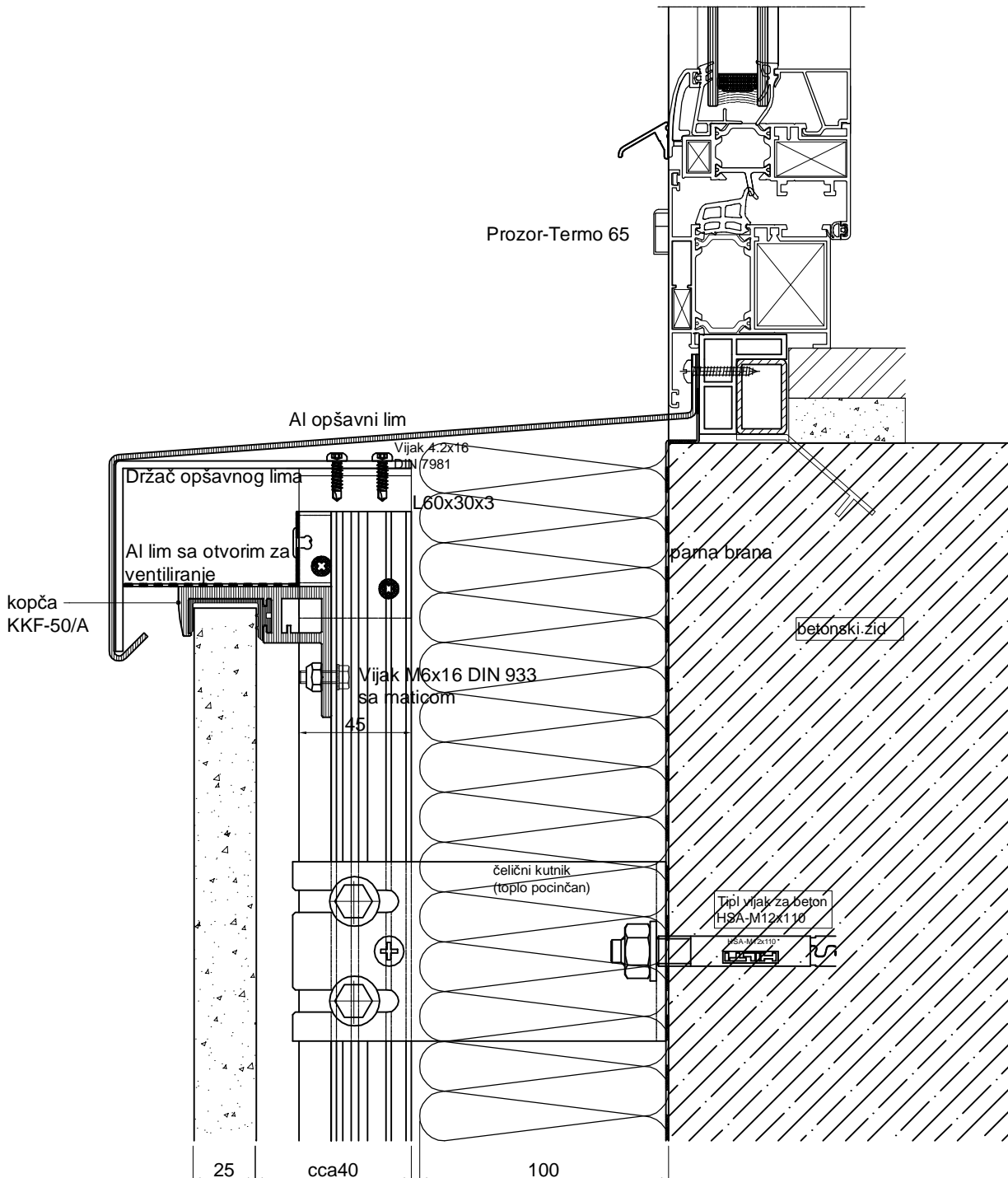

8

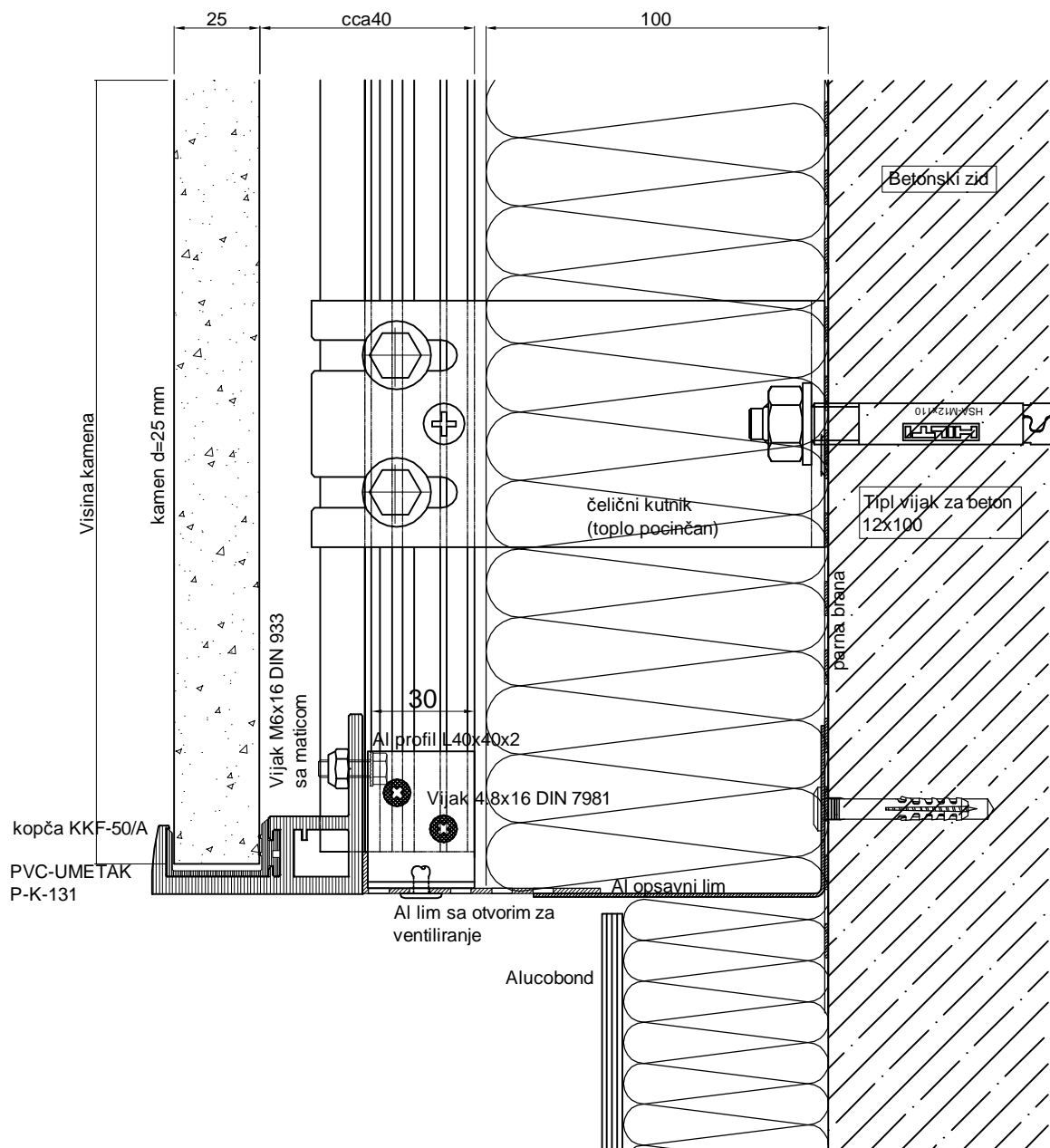

10

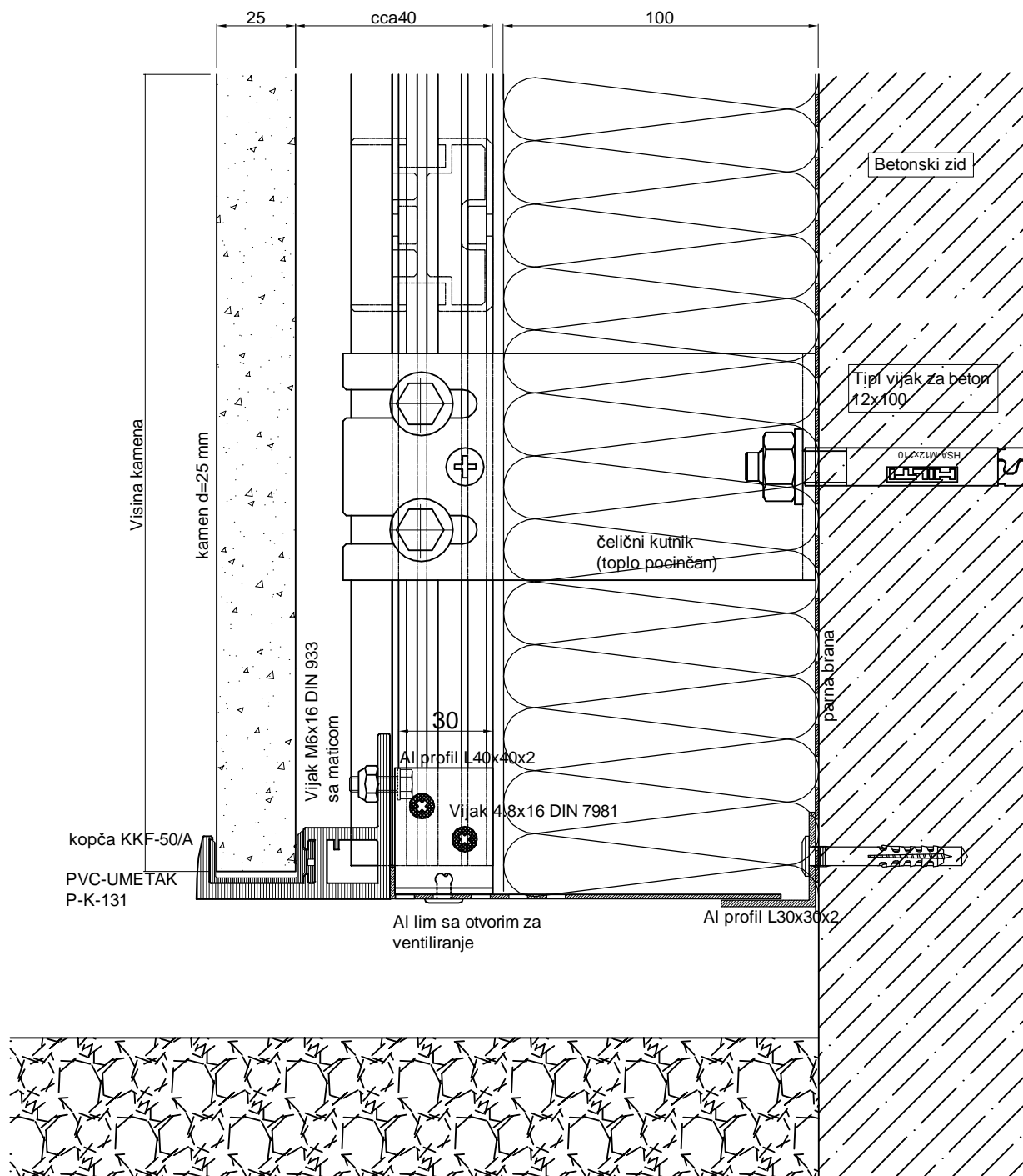

9

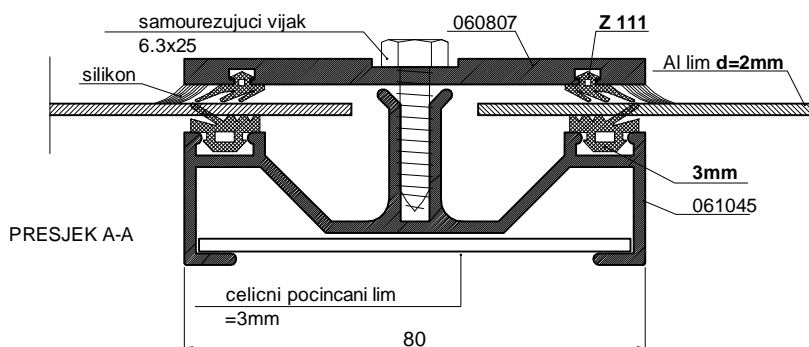
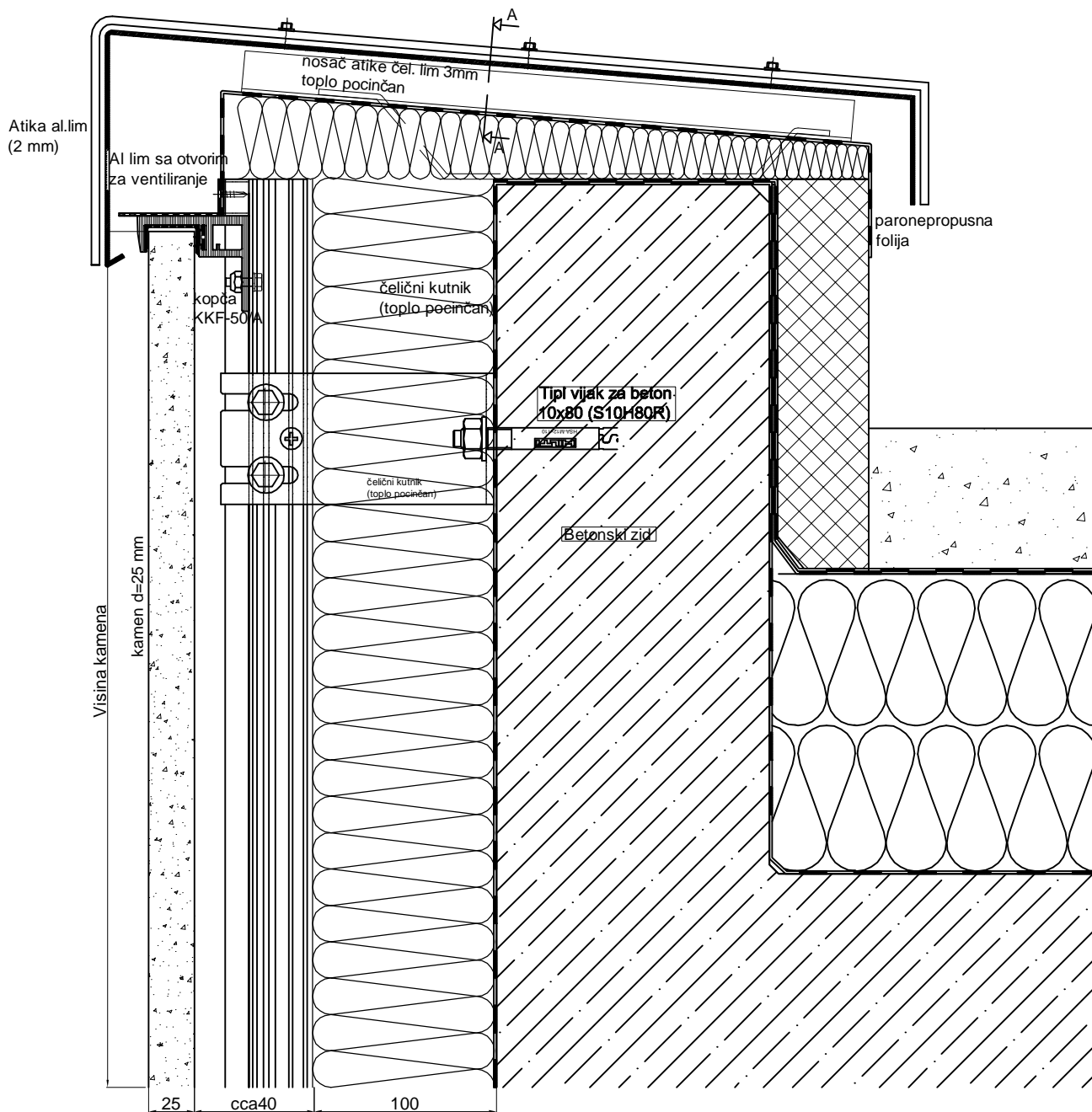

VENTILIRAJUĆE
FASADNE OBLOGE

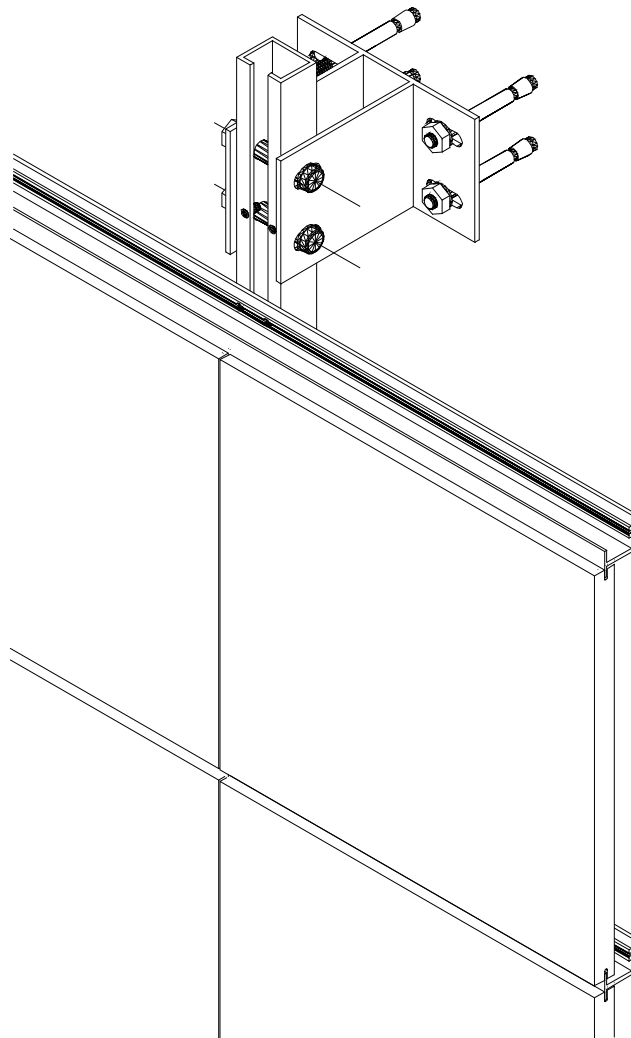

KAMENA FASADA SA
NEVIDLJIVOM KOPČOM
KF-1

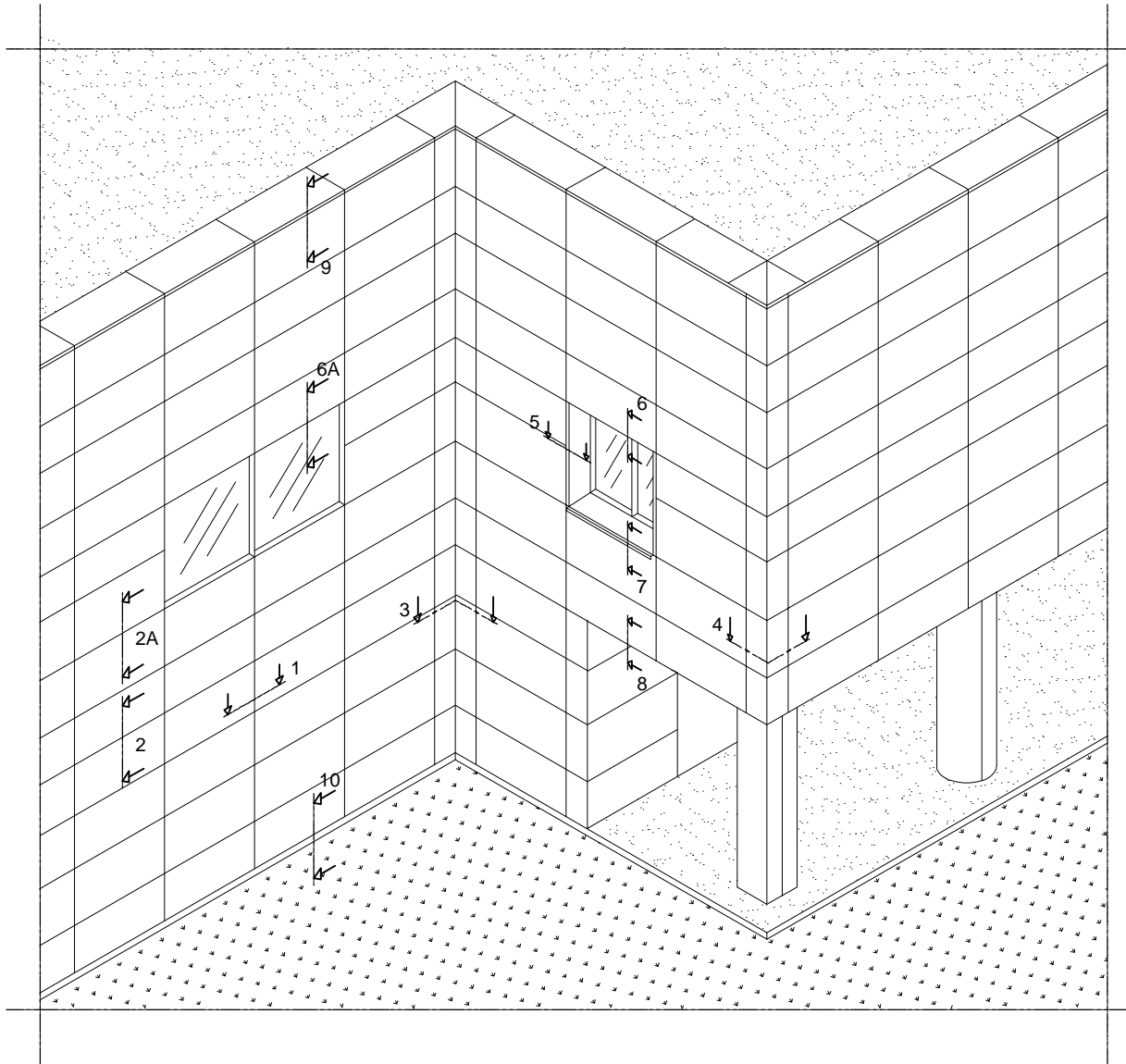

1

FASADA SA VIDLJIVOM OKOMITOM
I VODORAVNOM FUGOM 8 mm

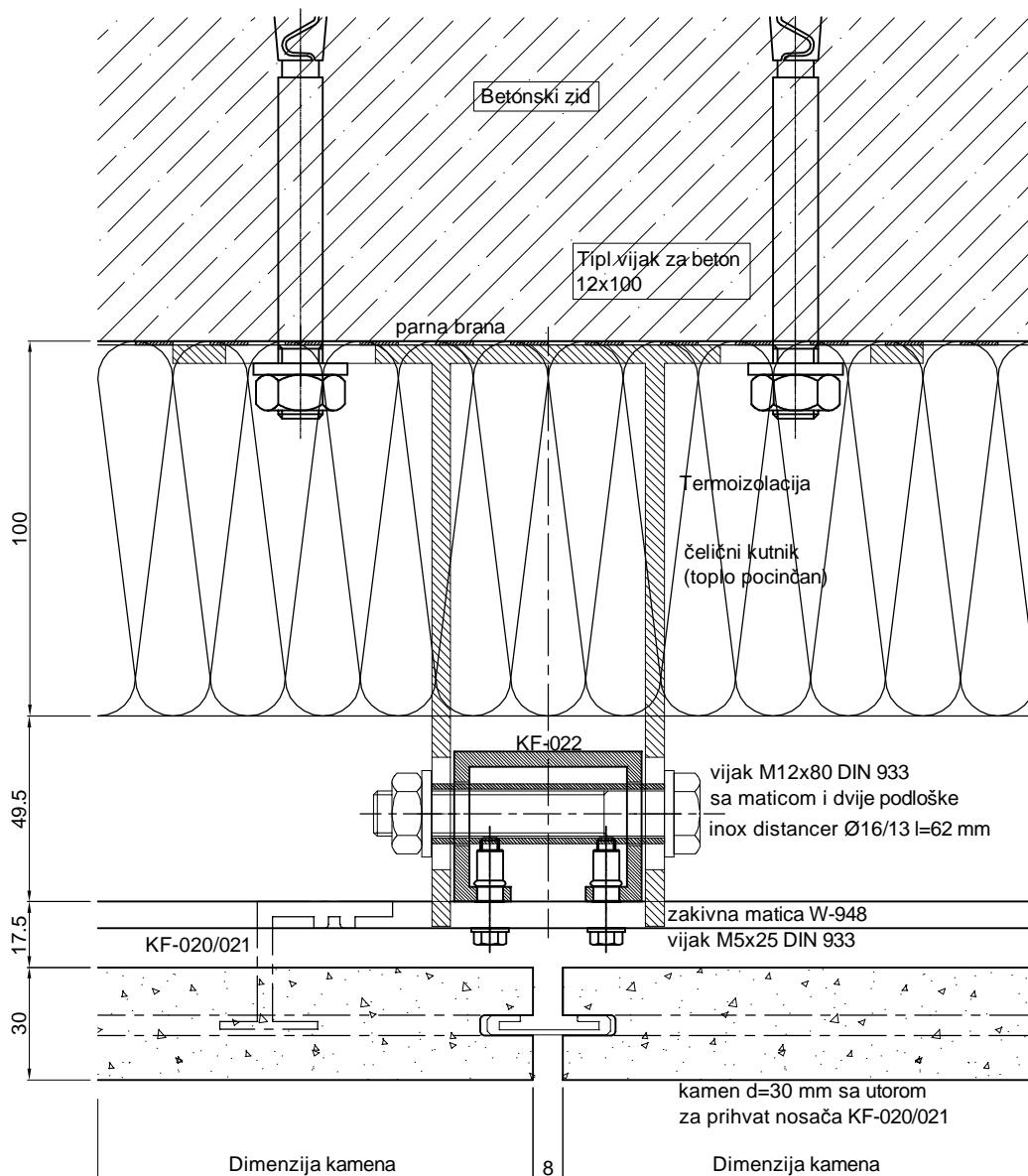

1

FASADA SA VIDLJIVOM VODORAVNOM FUGOM 8 mm I
NEVIDLJIVOM OKOMITOM FUGOM (1 mm ispuna akrilni kit)

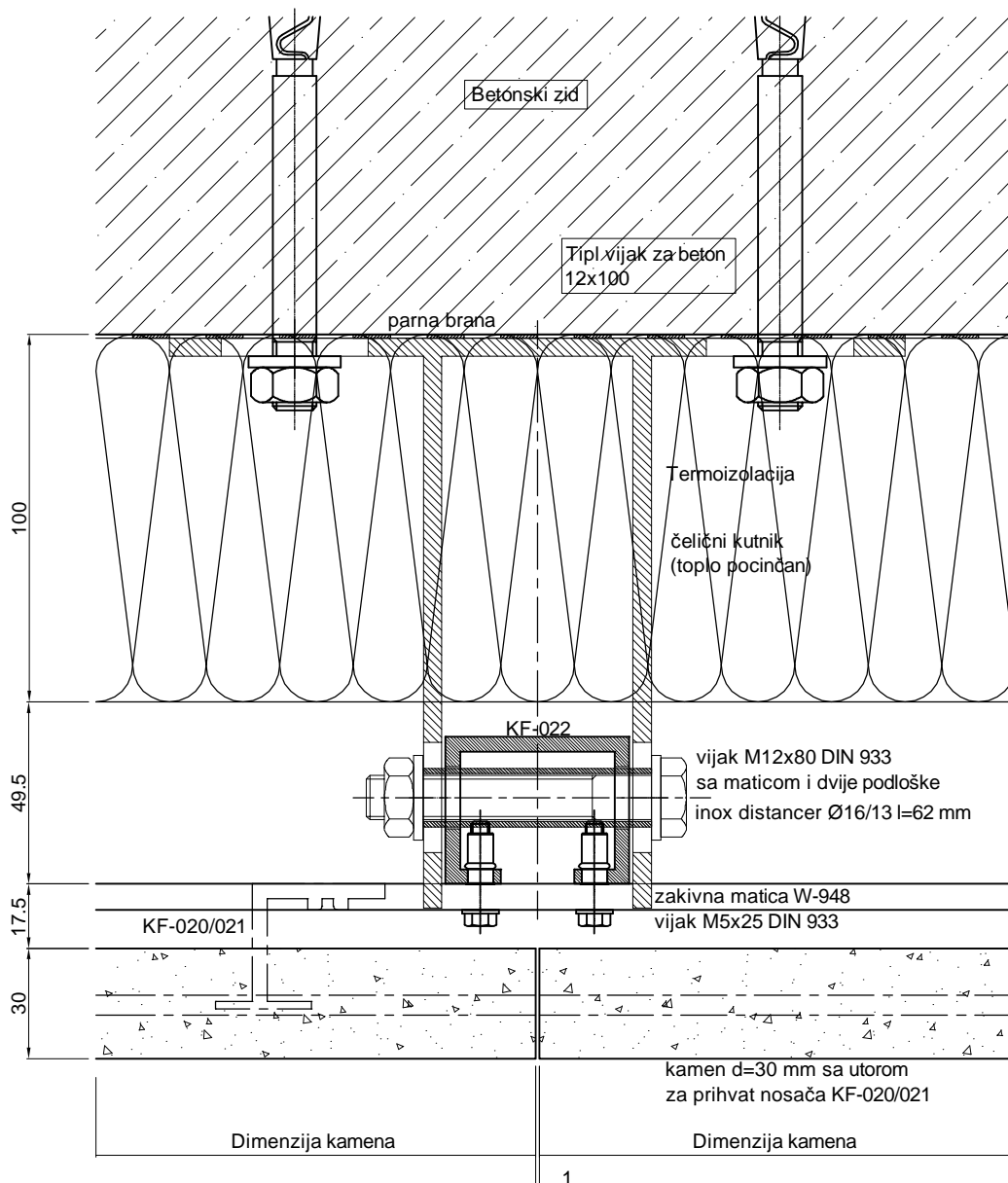

②

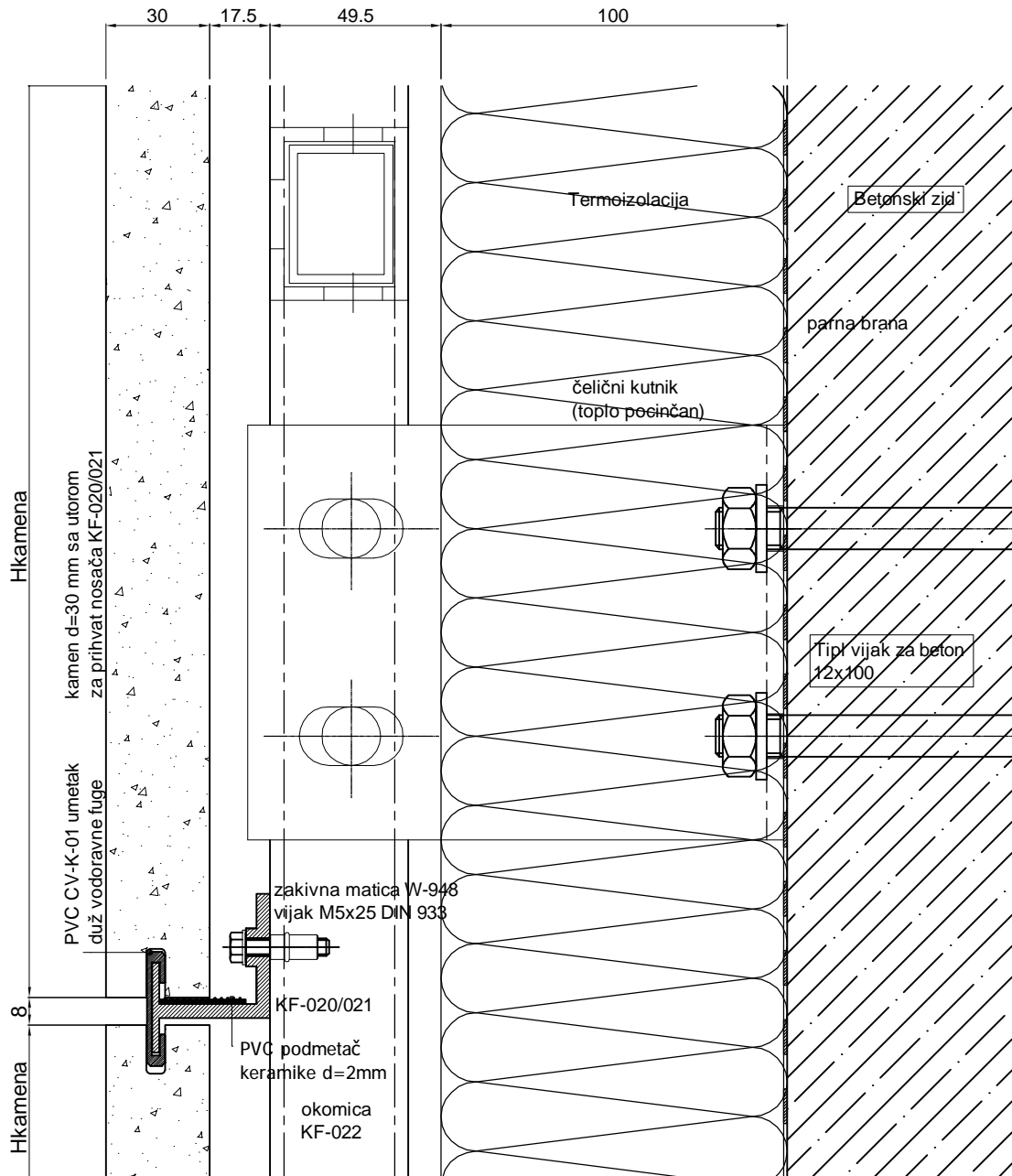

③

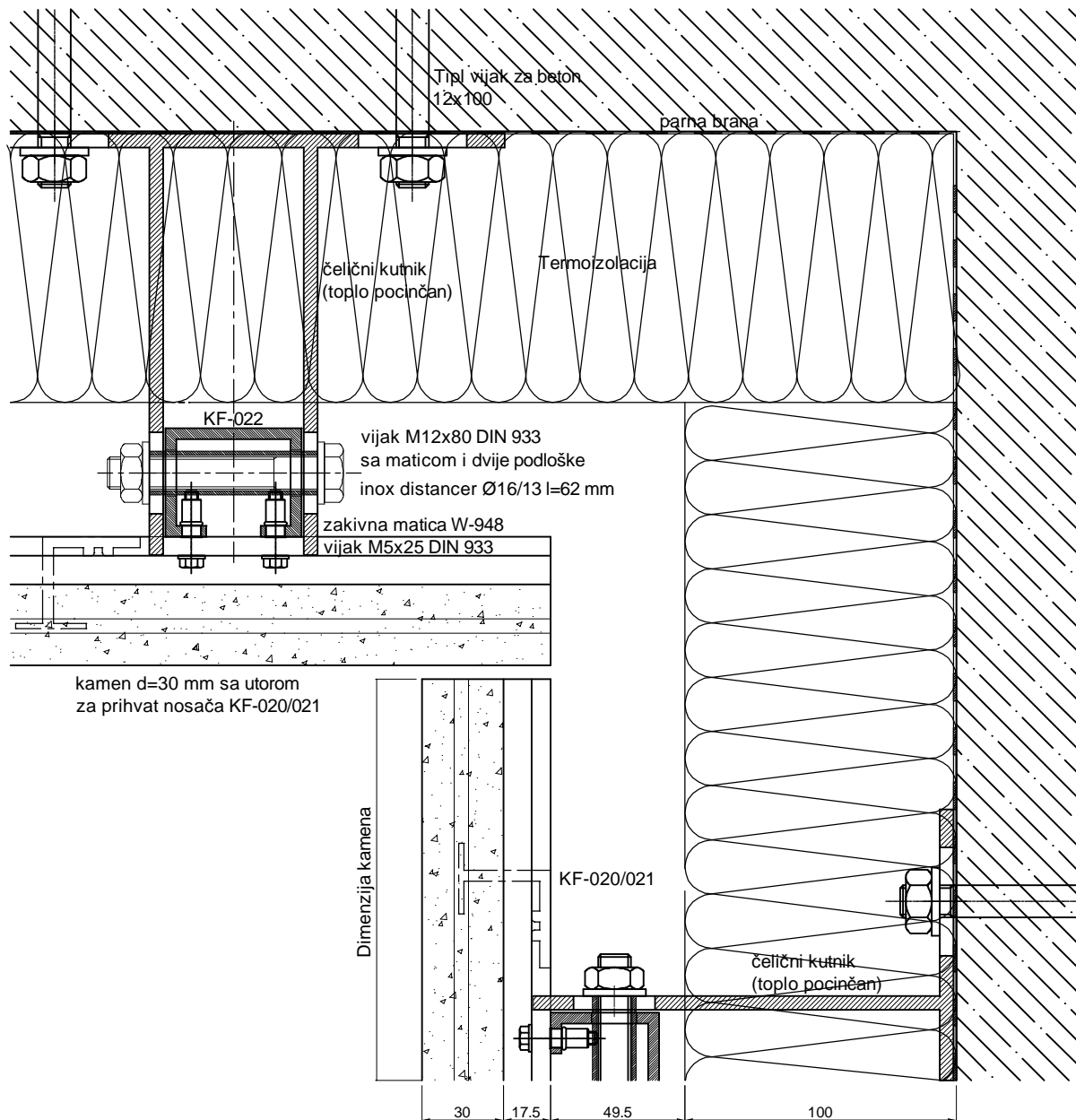

④

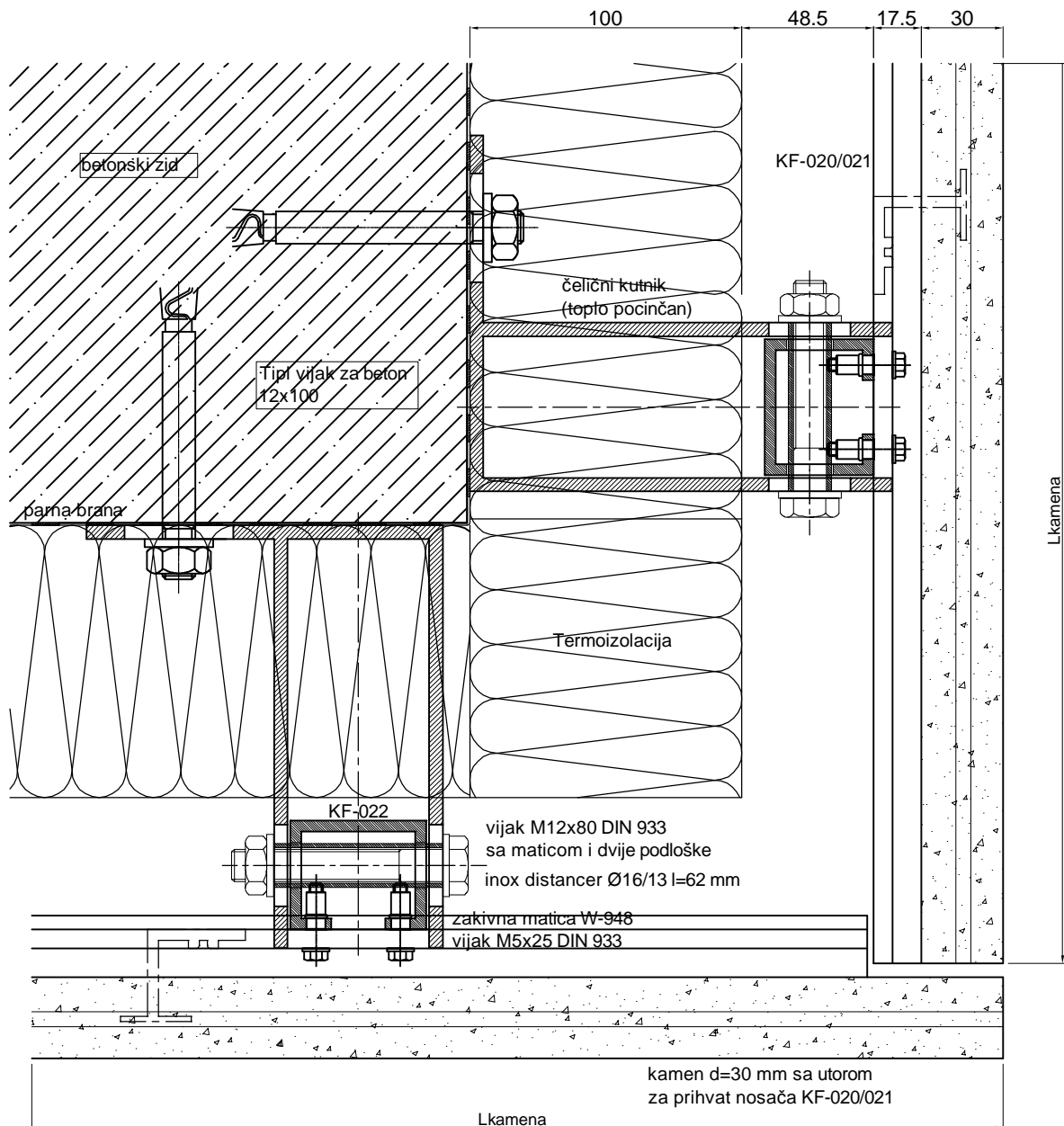

5

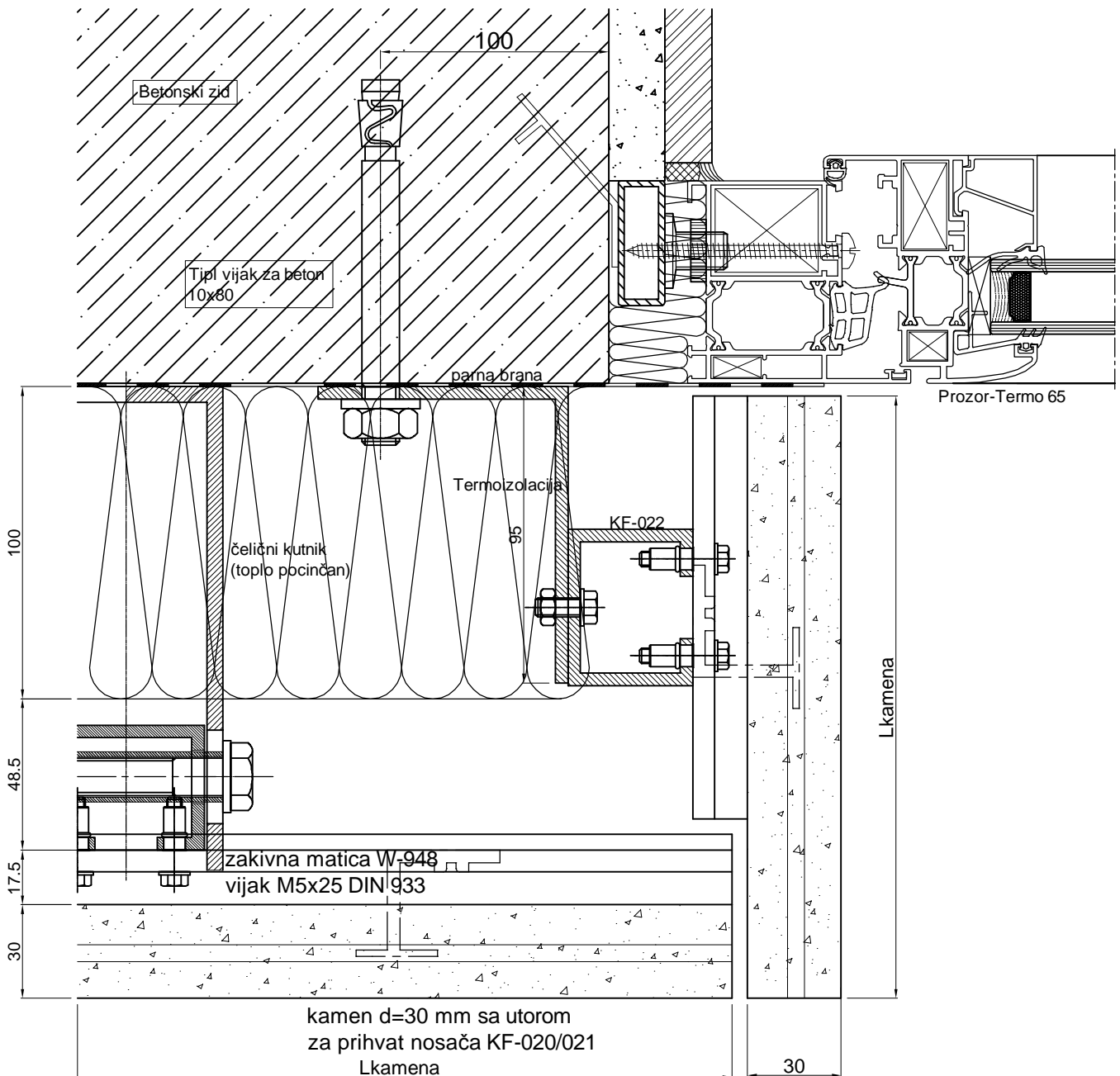

⑥

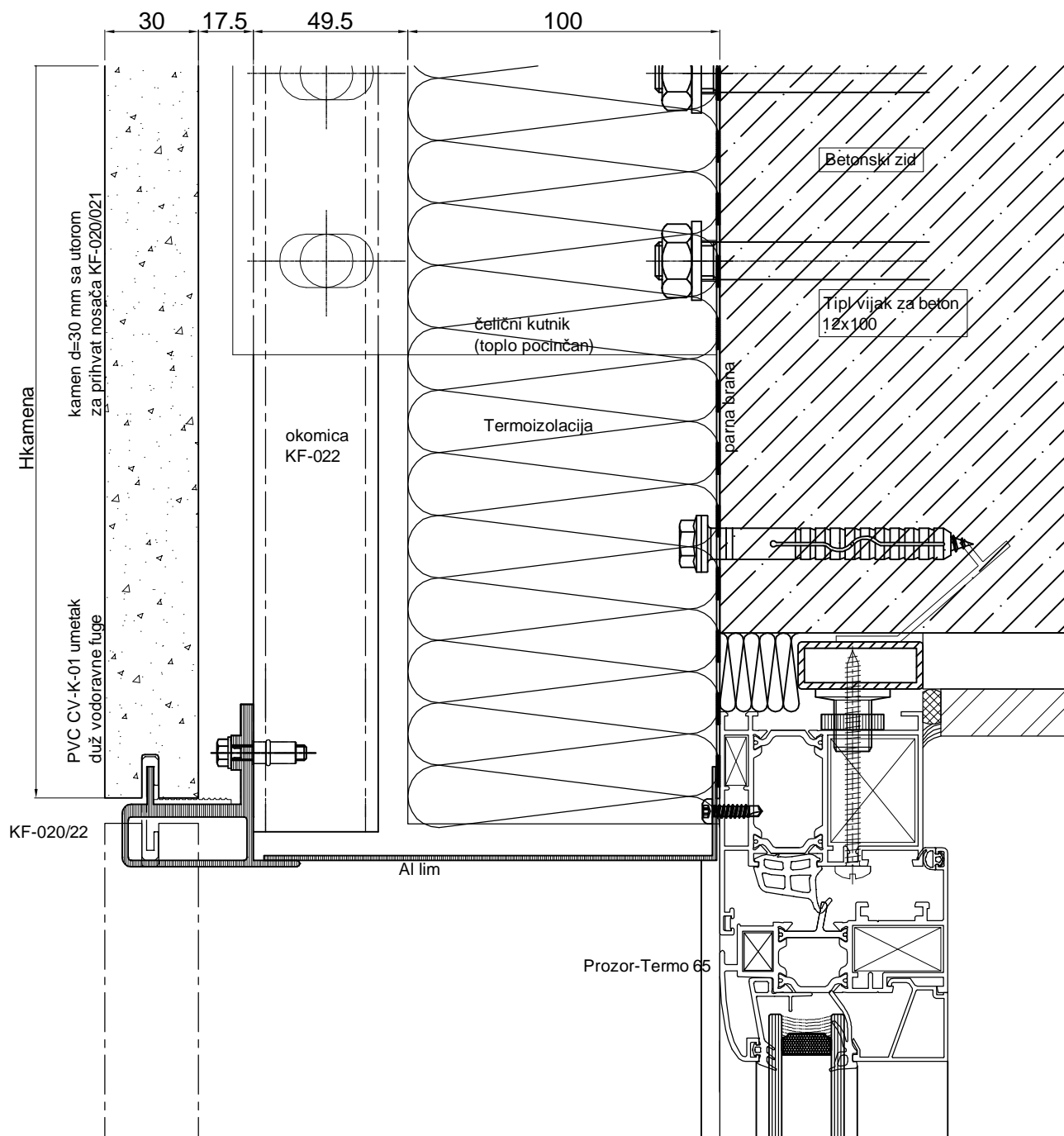

6A

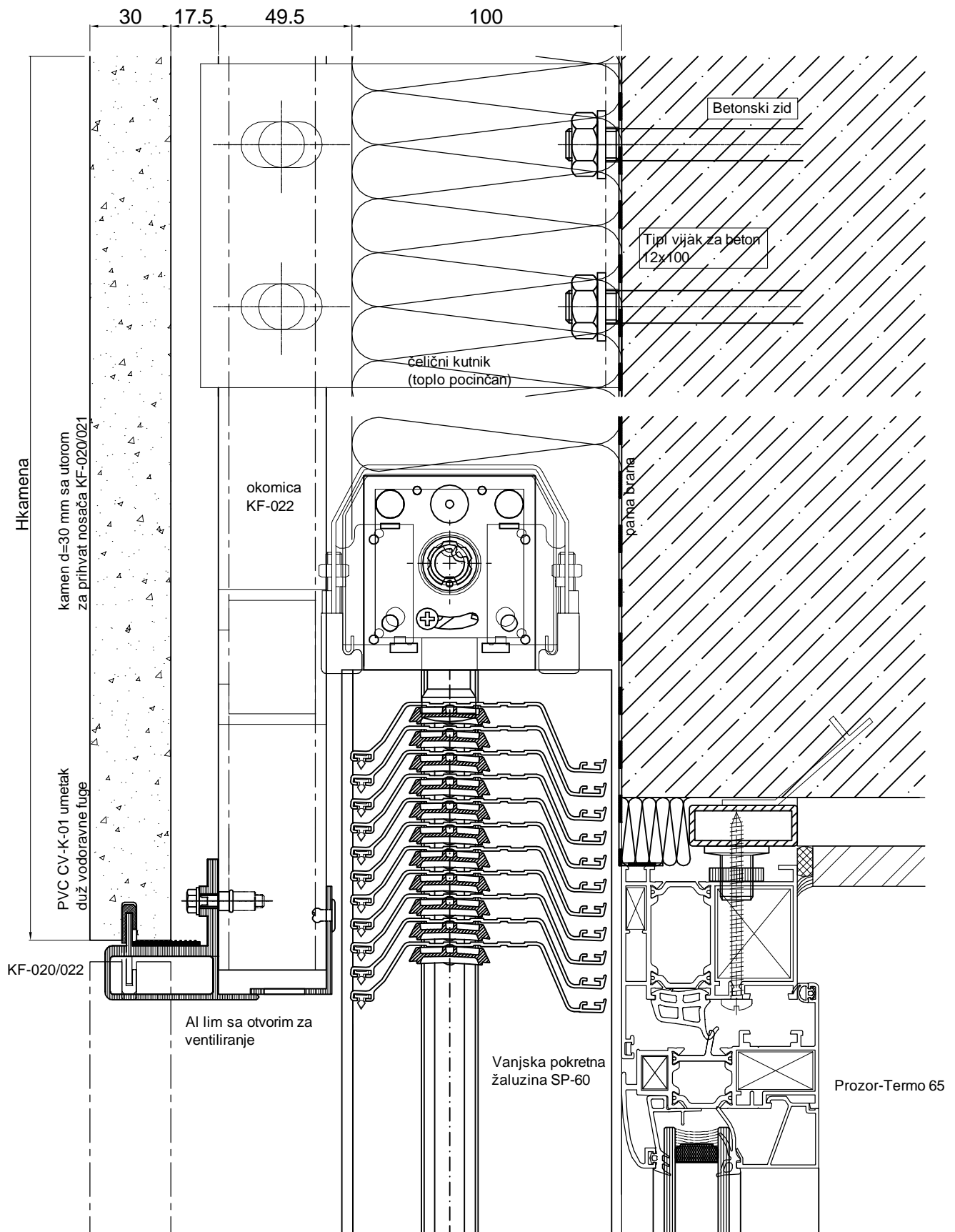

7

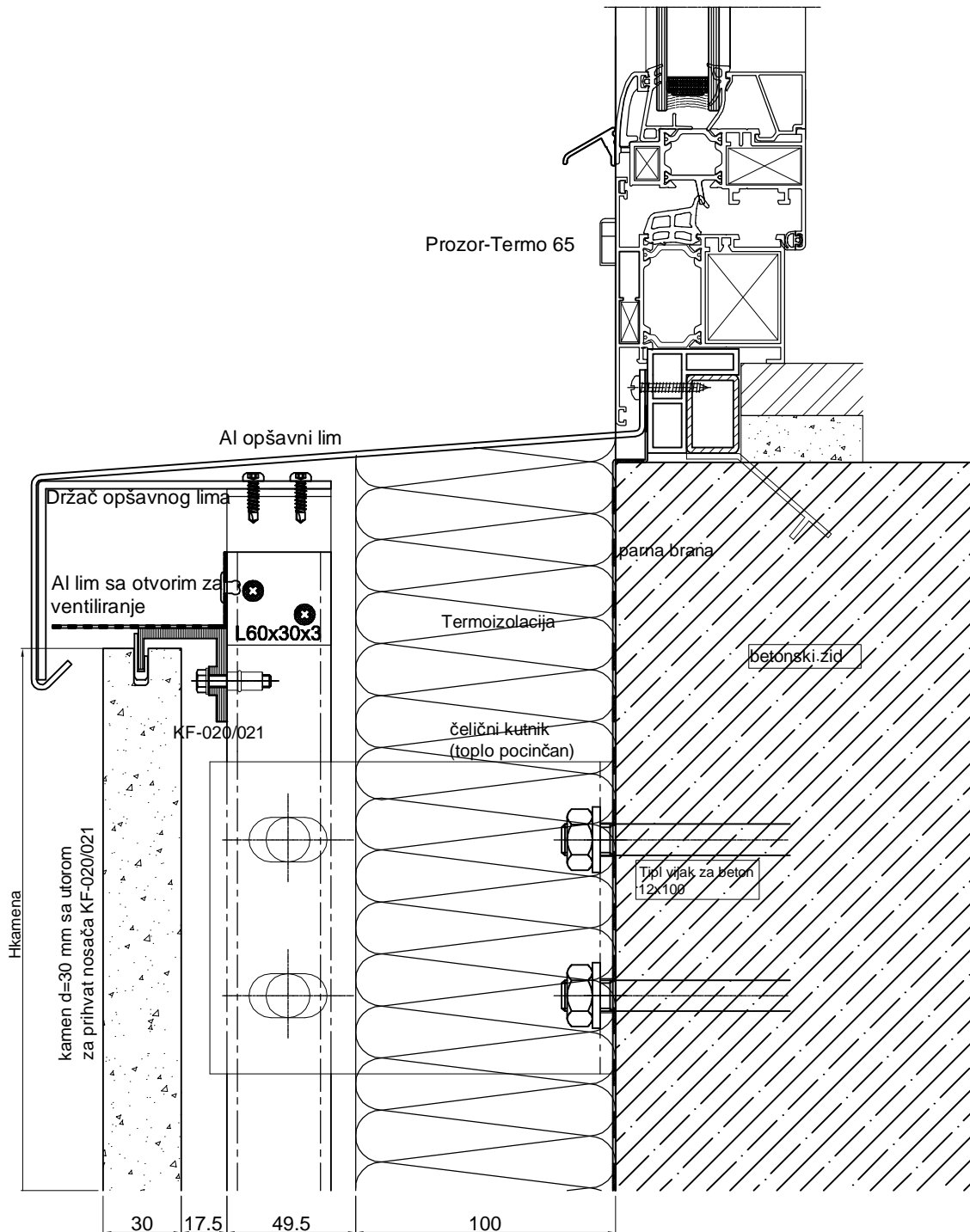

8

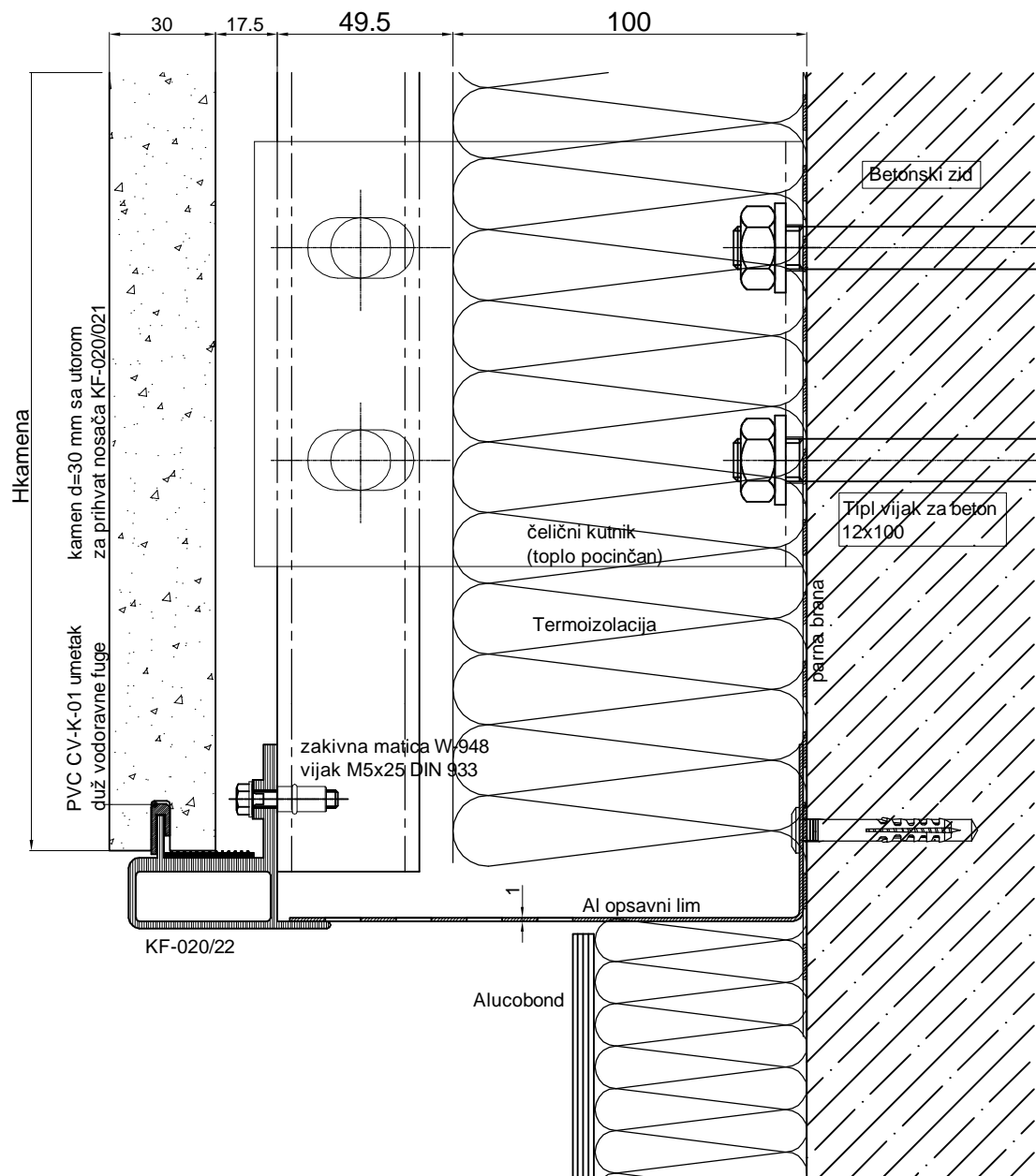

10

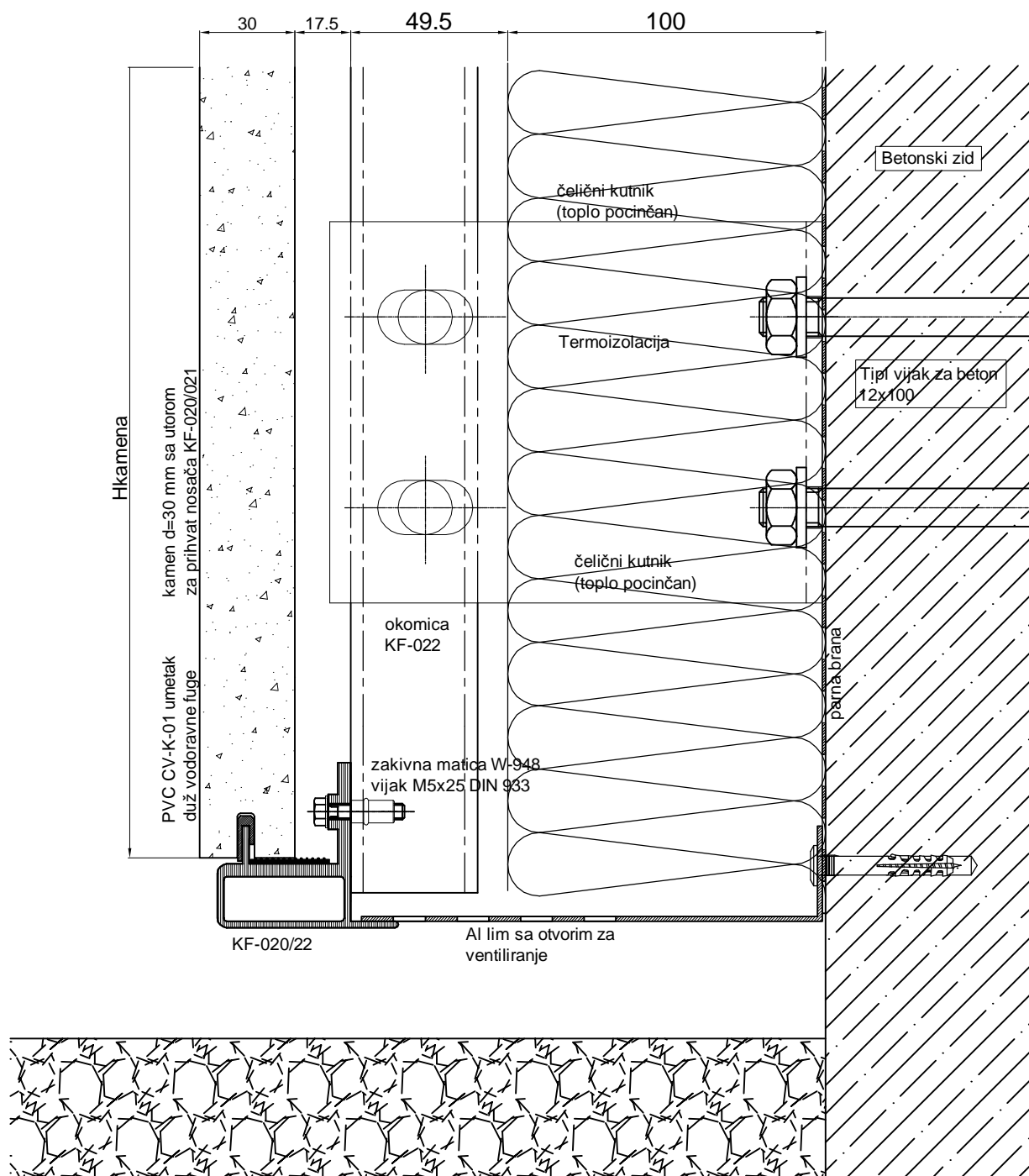

9

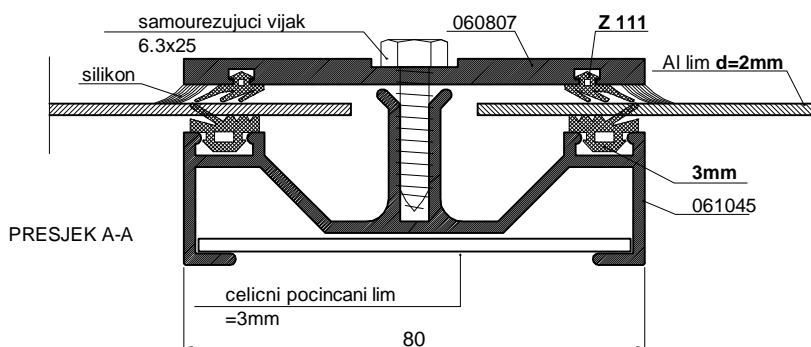
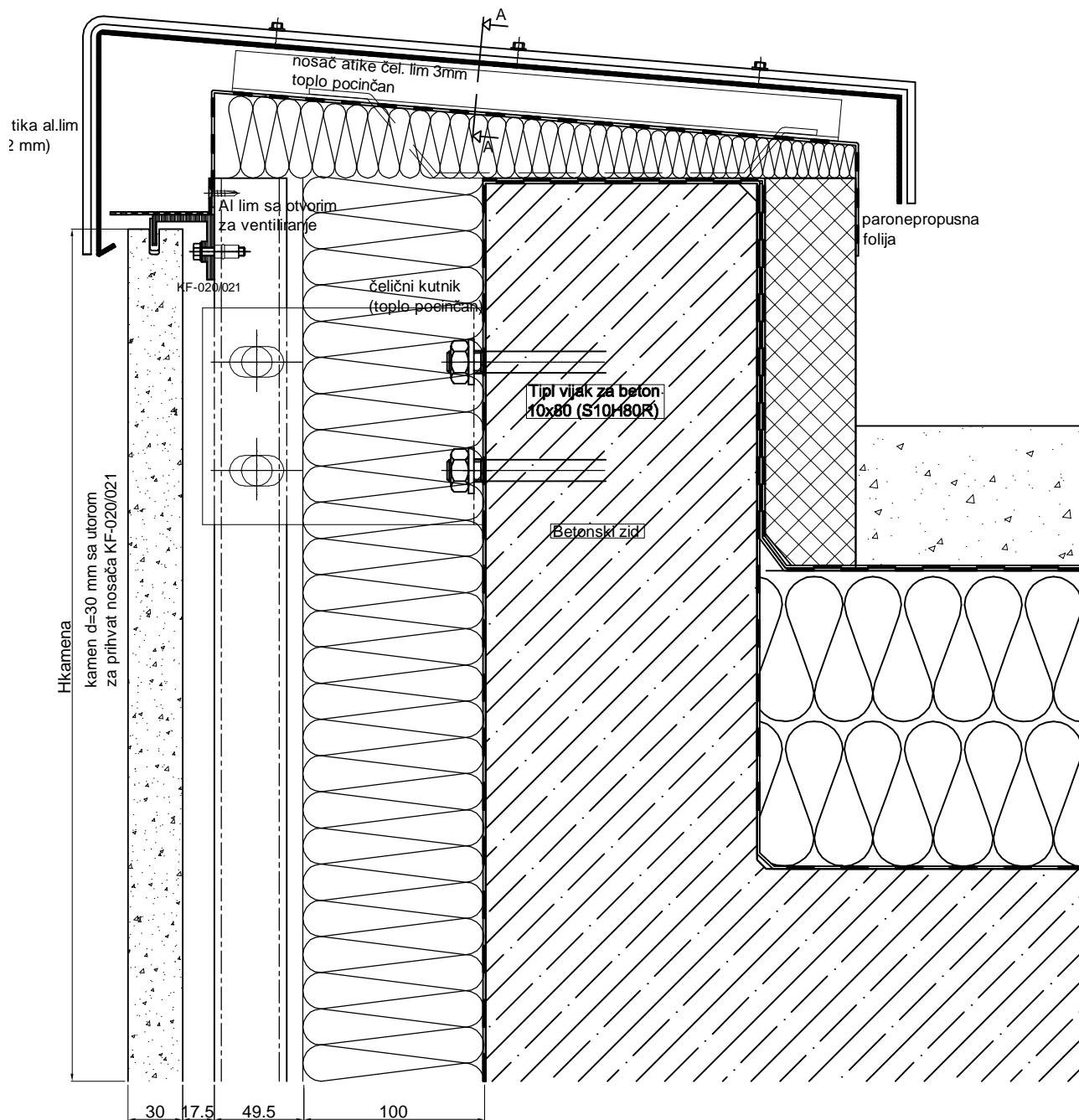

KAMENA FASADA -obrade i montaža-

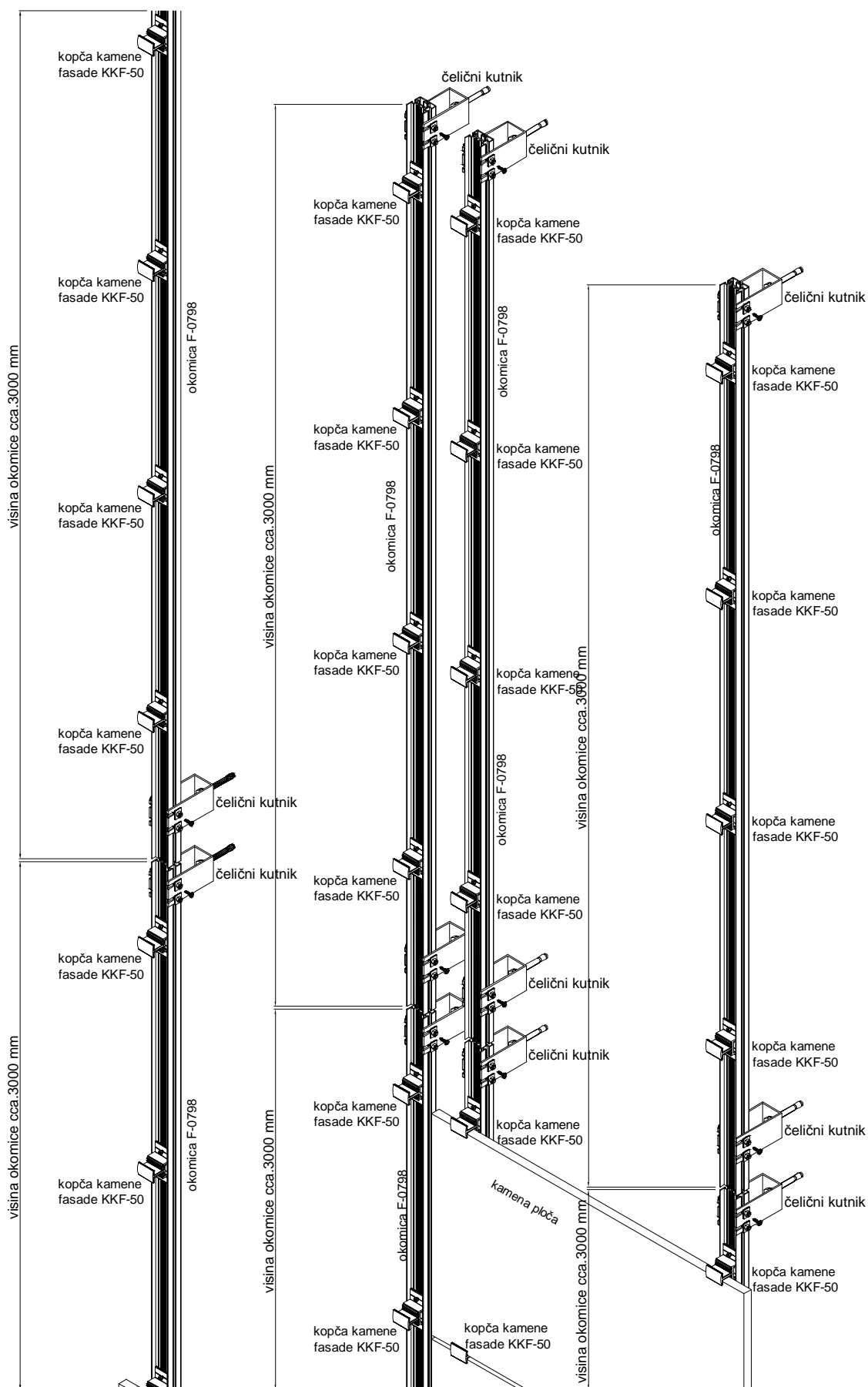

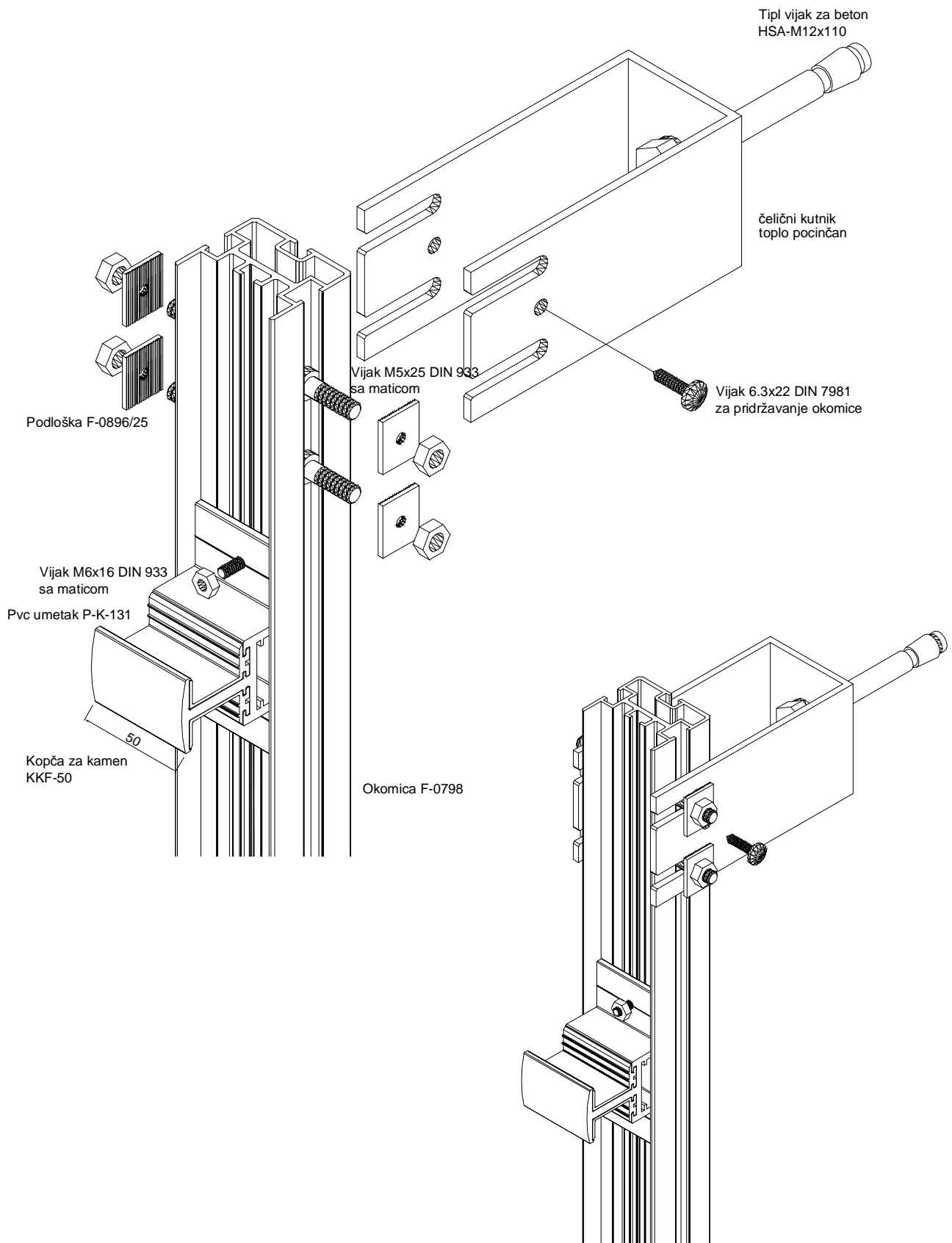

VENTILIRAJUĆE
FASADNE OBLOGE

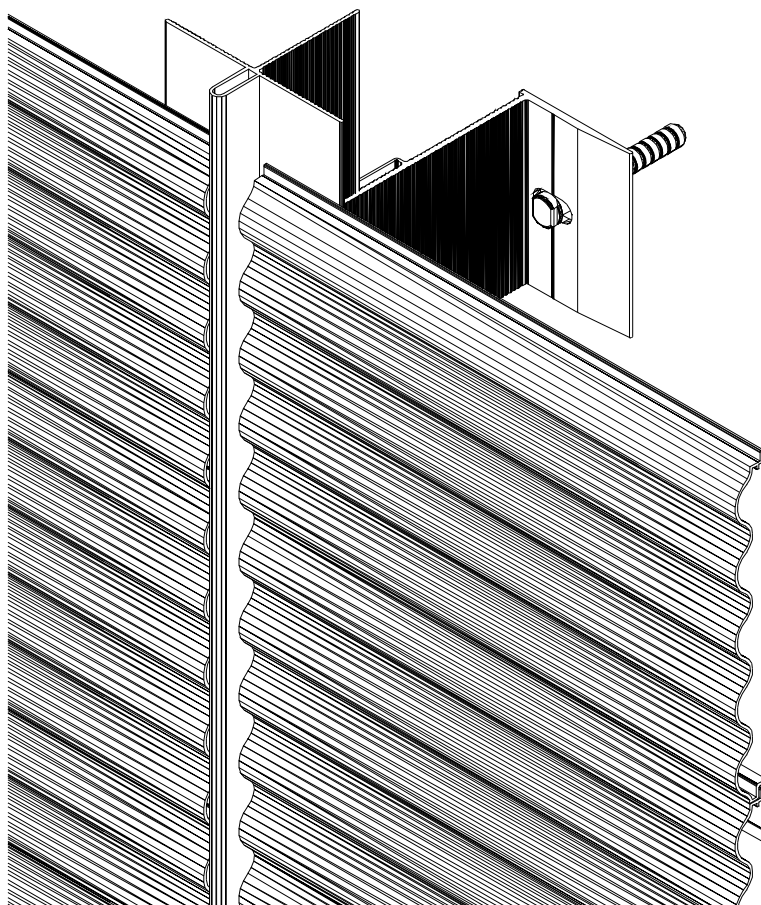

VAL 331

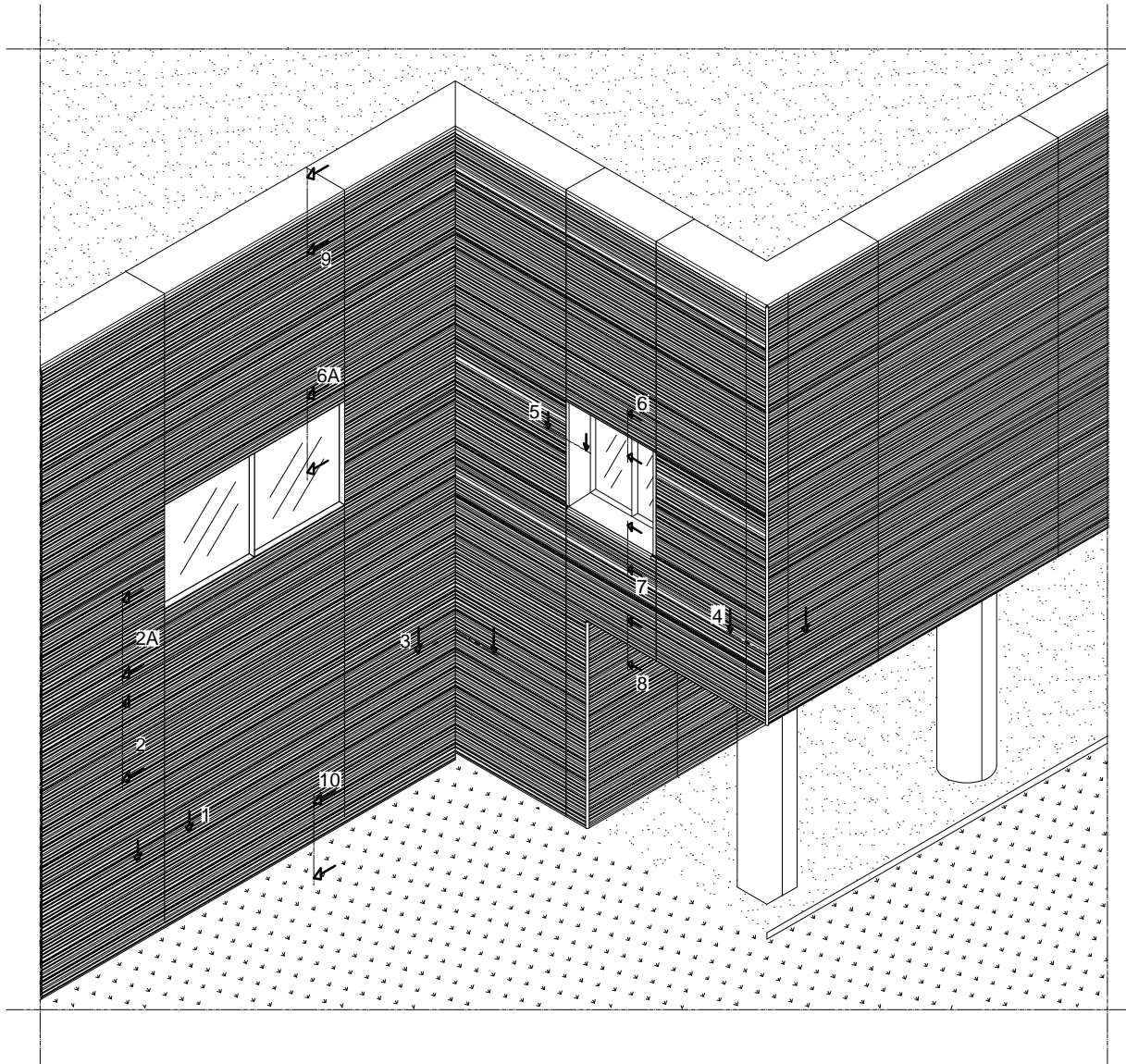

①

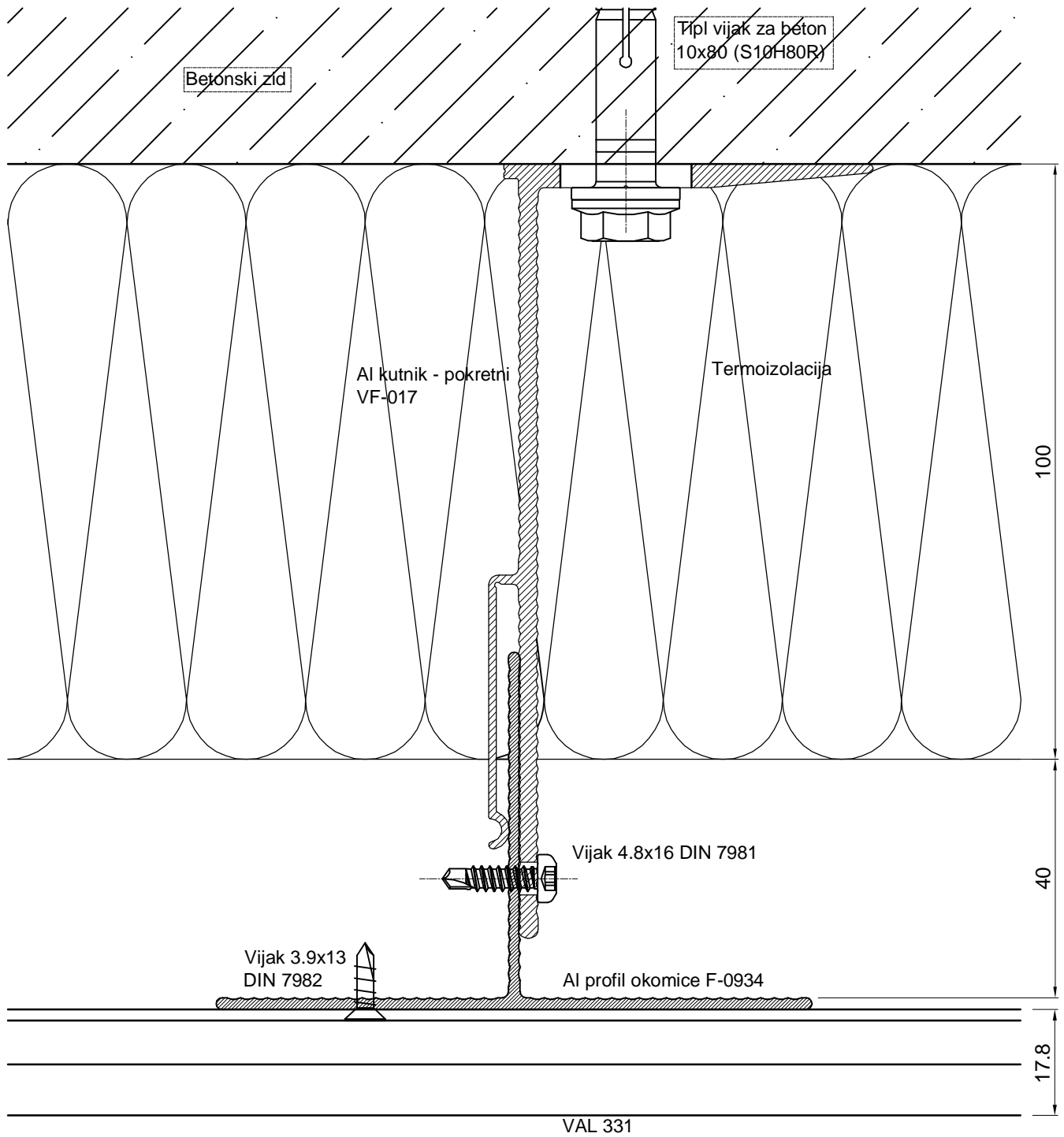

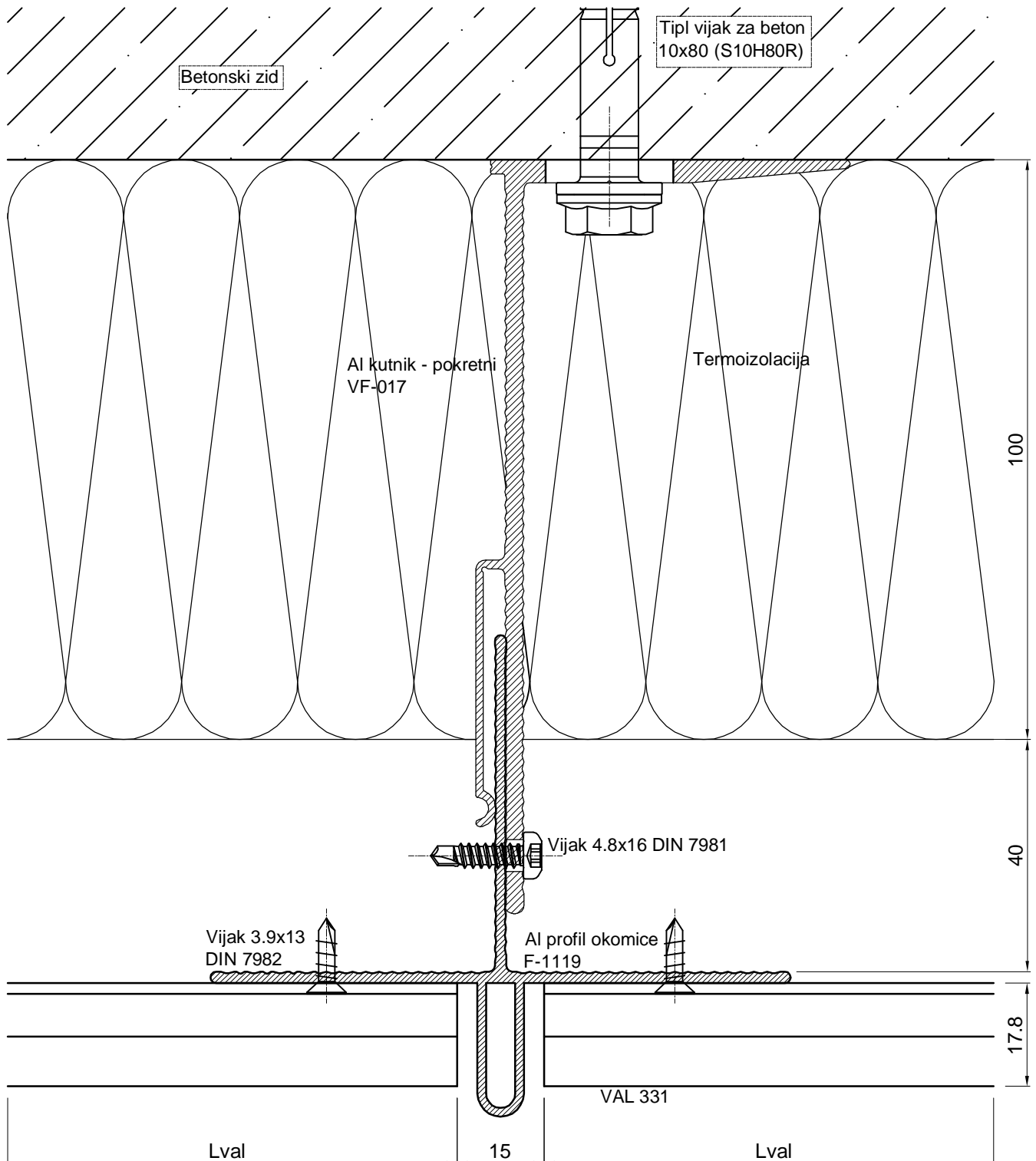

②

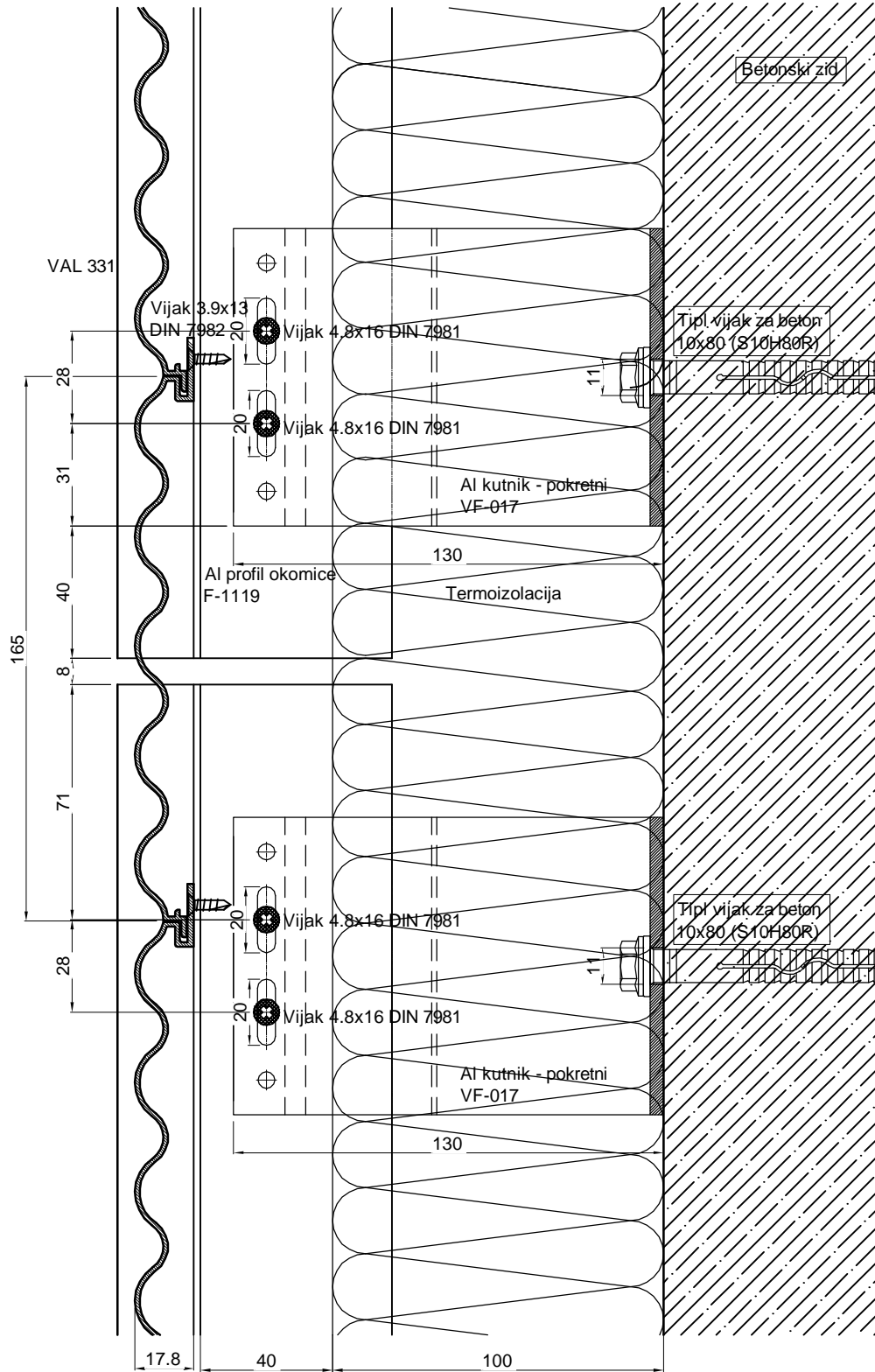

②

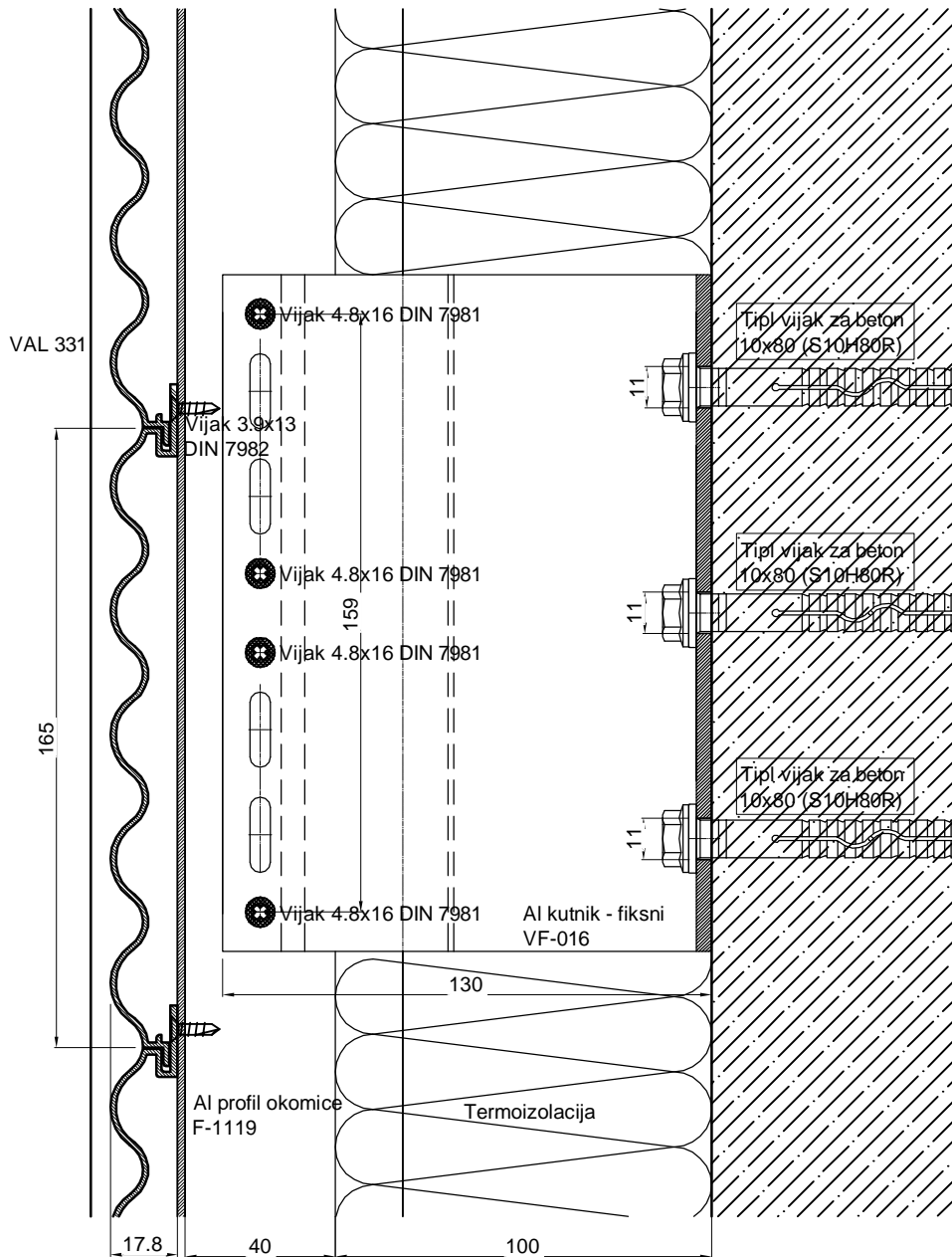

③

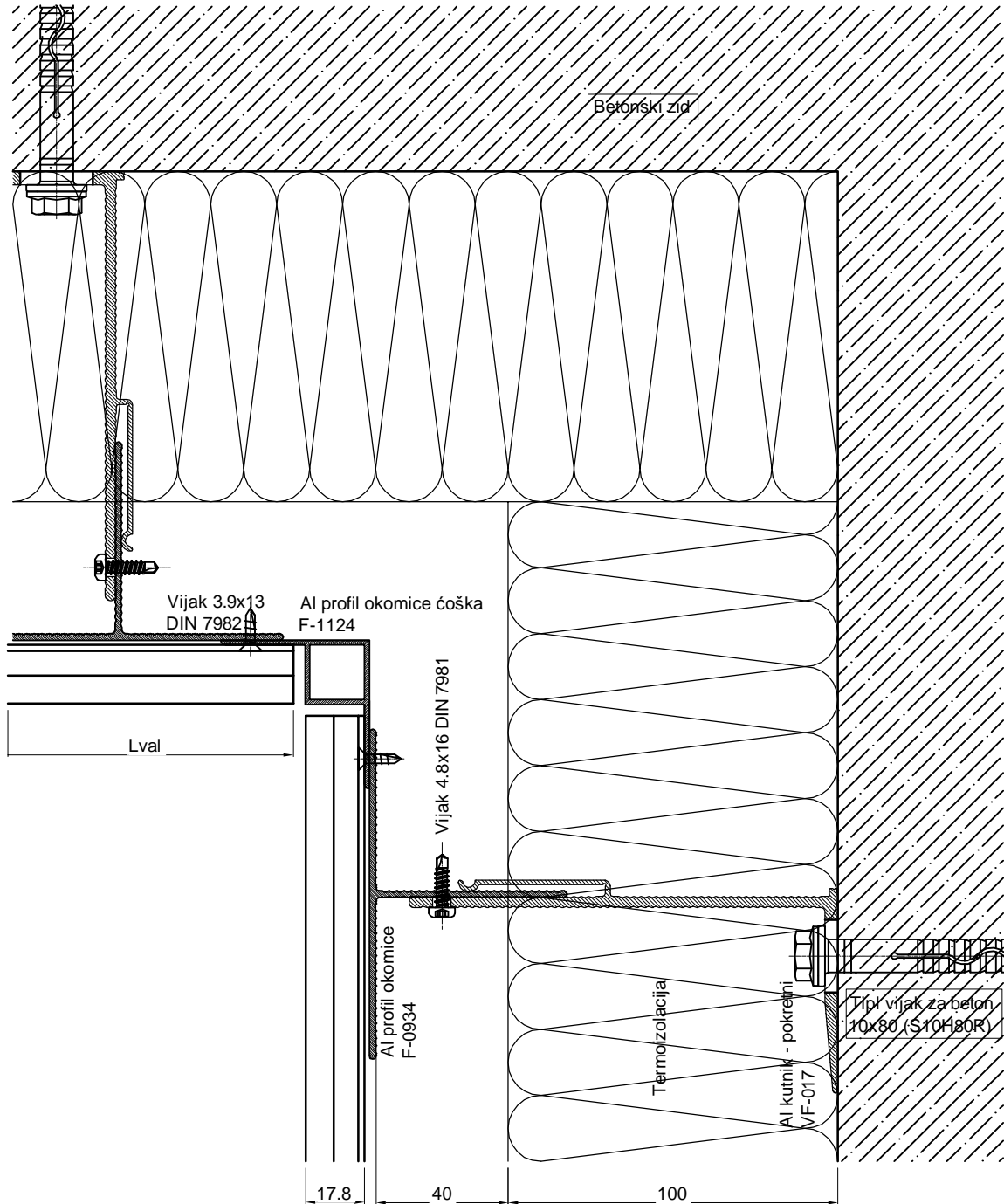

④

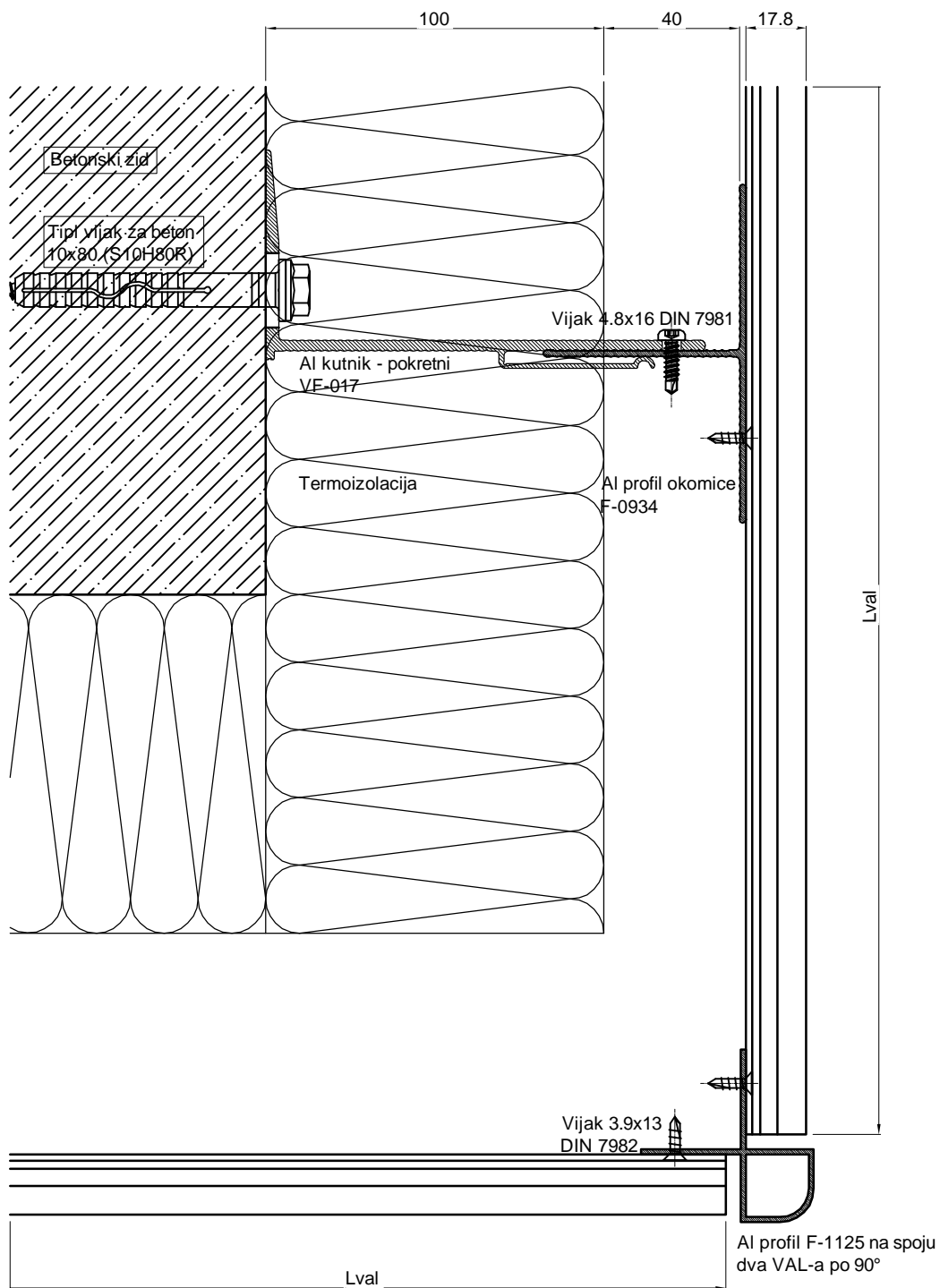

5

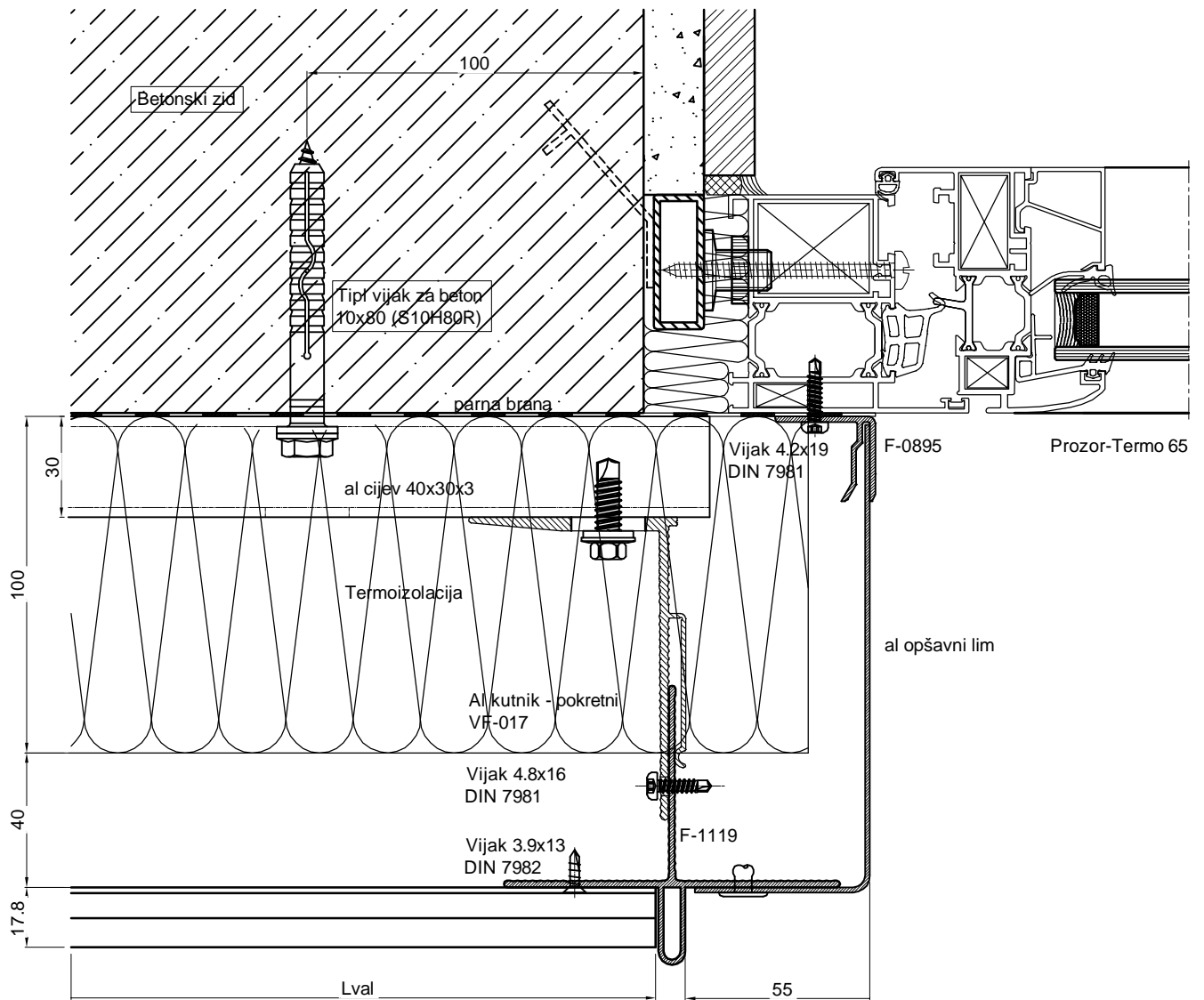

⑥

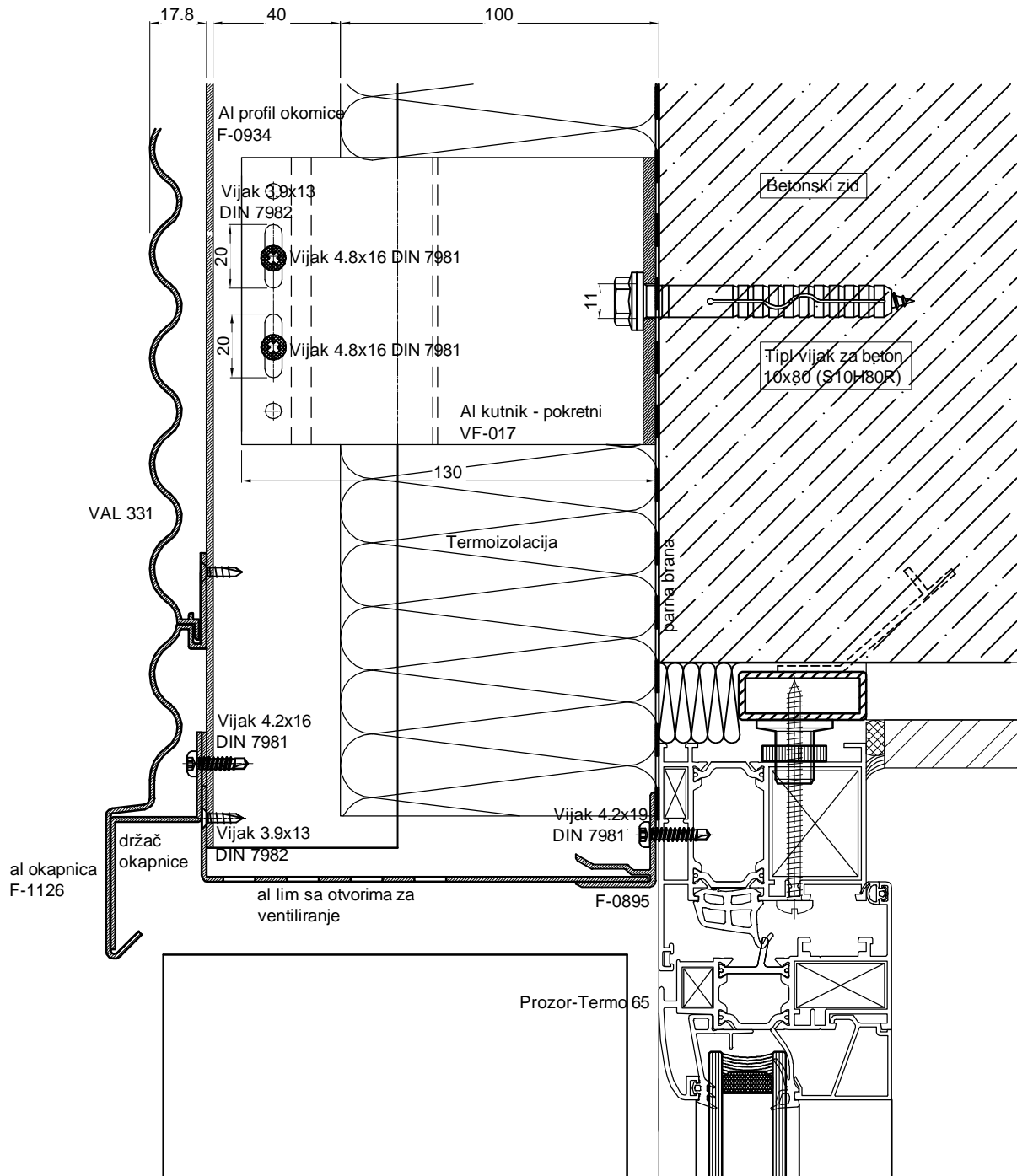

6A

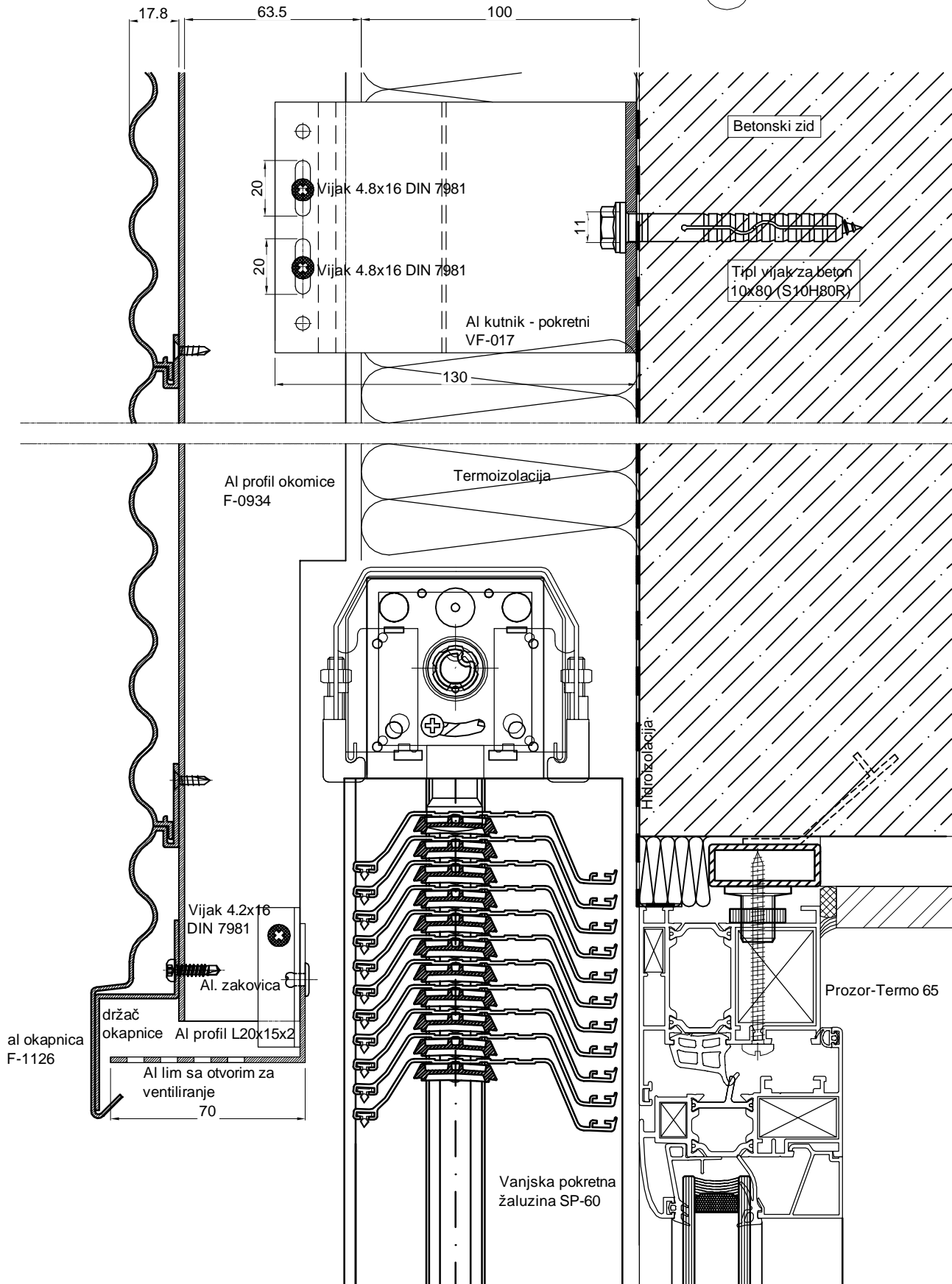

⑦

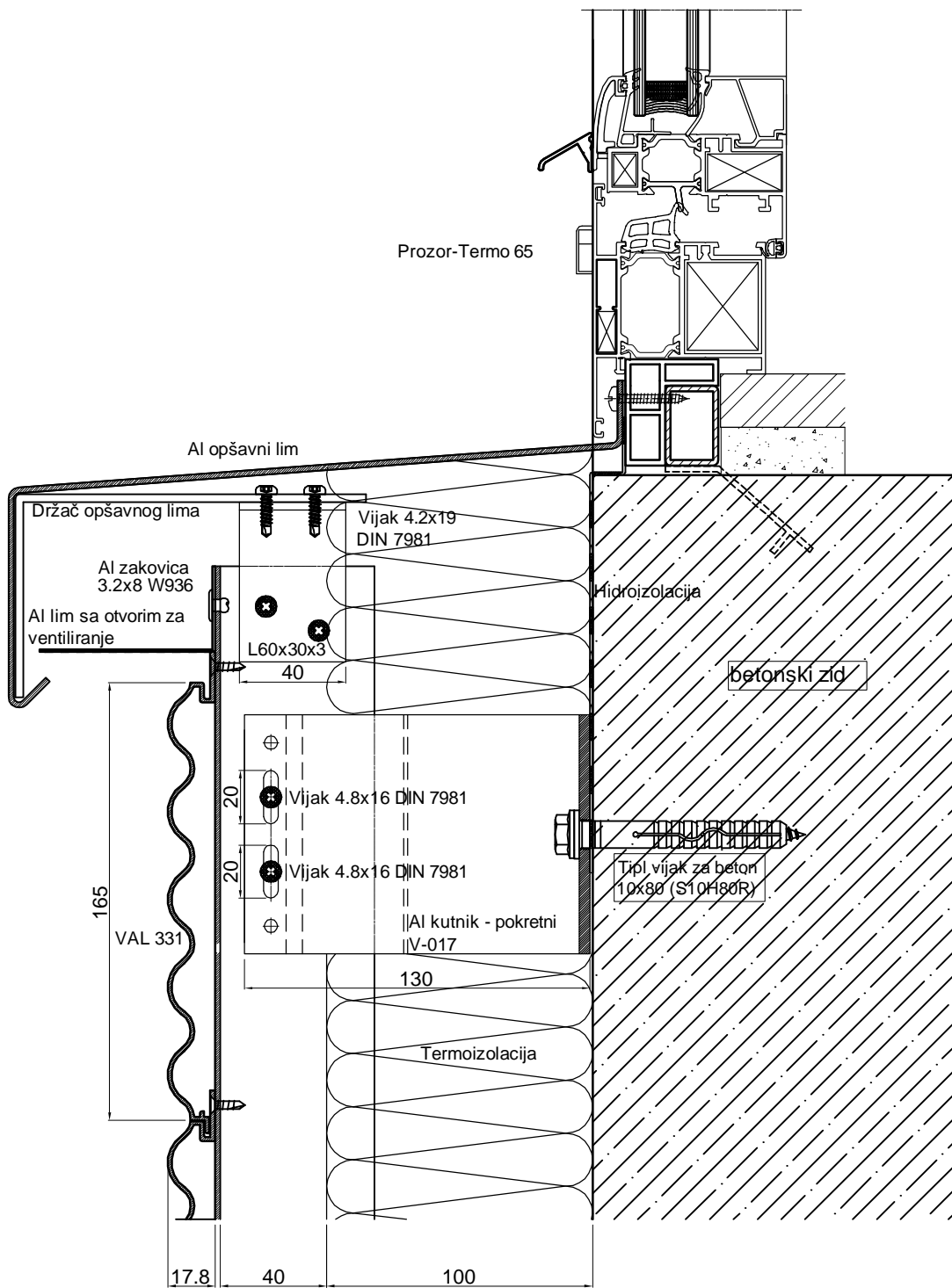

8

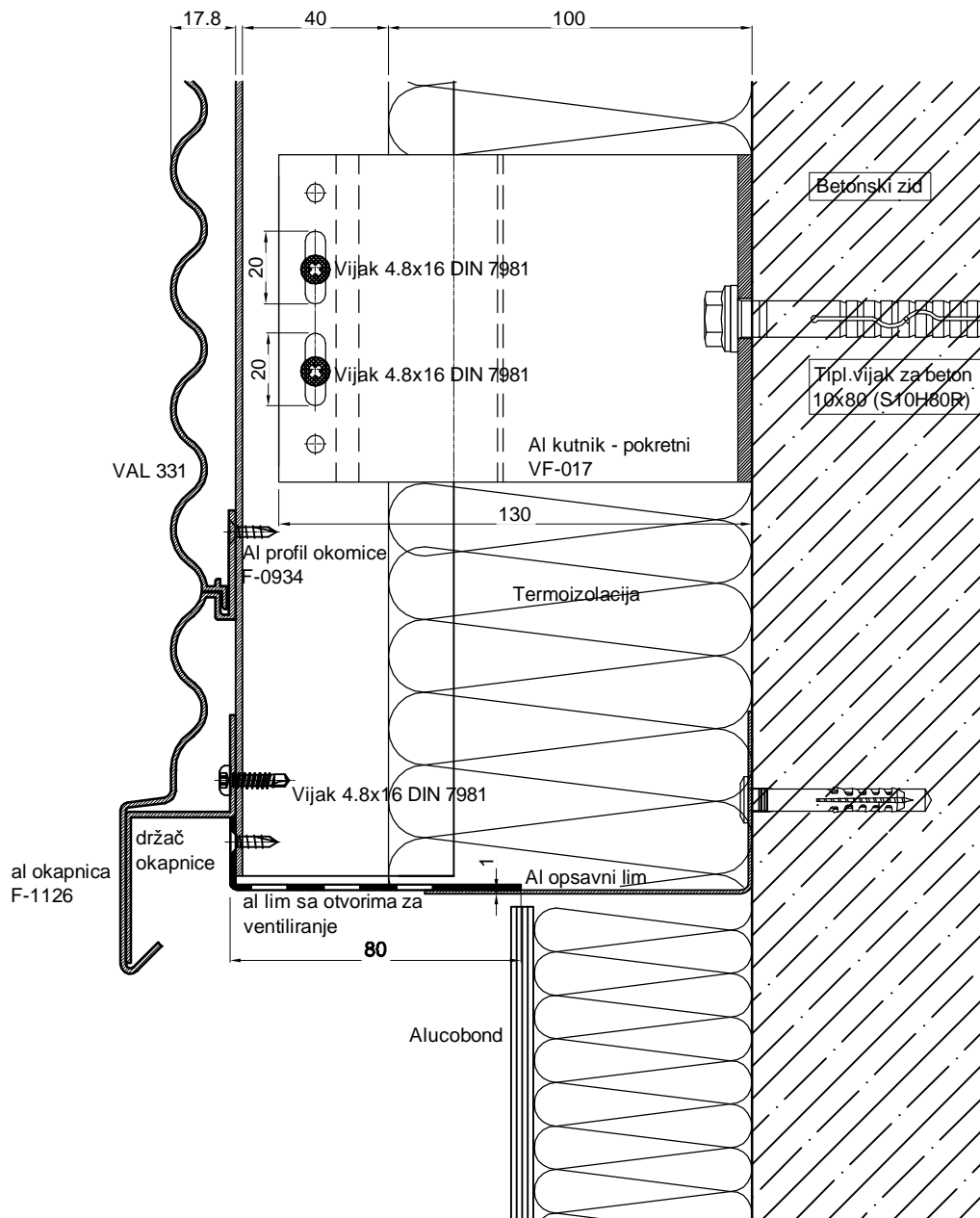

9

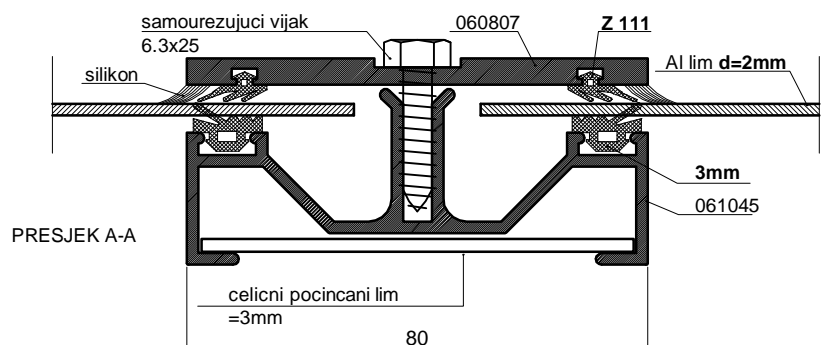
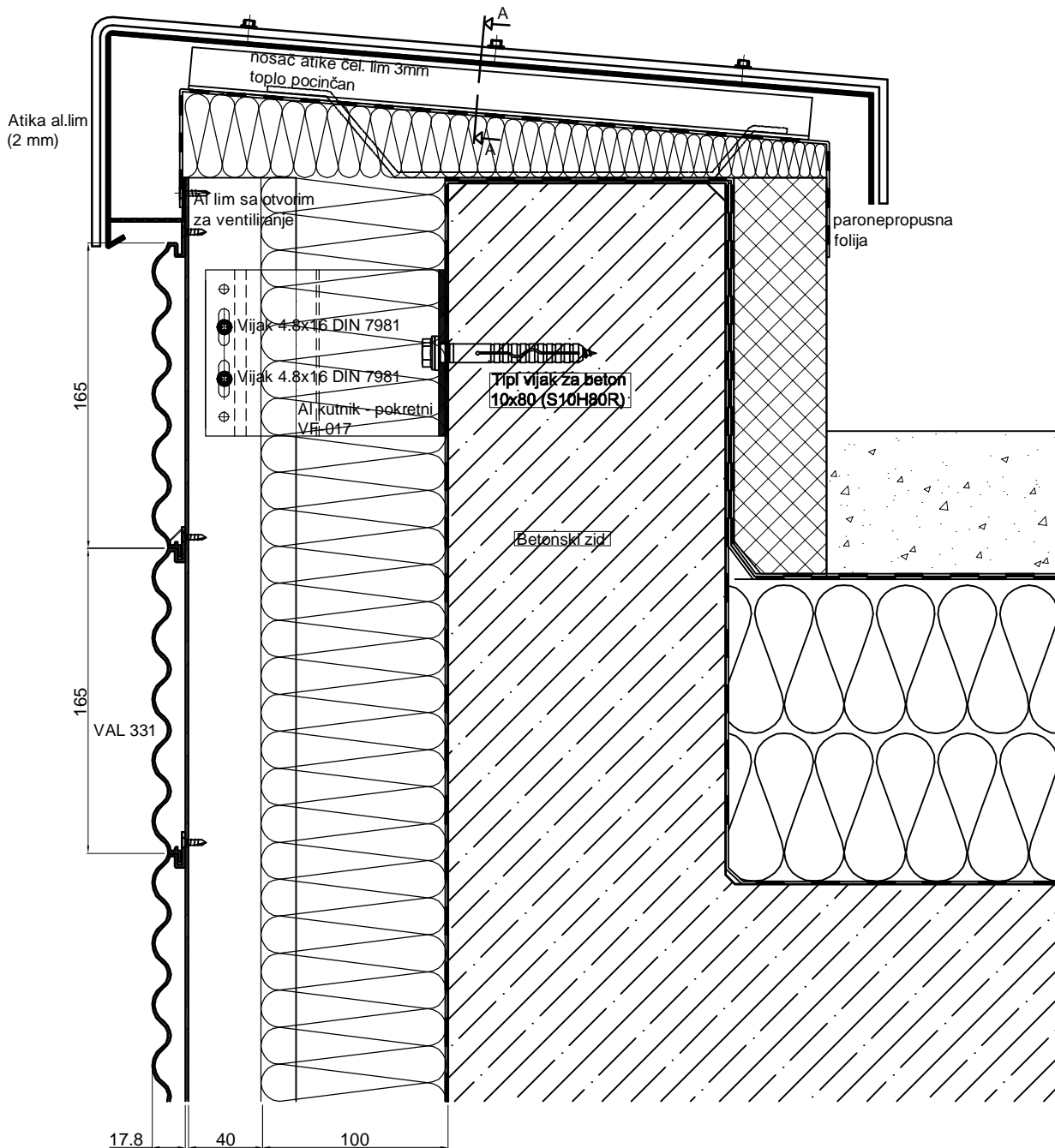

10

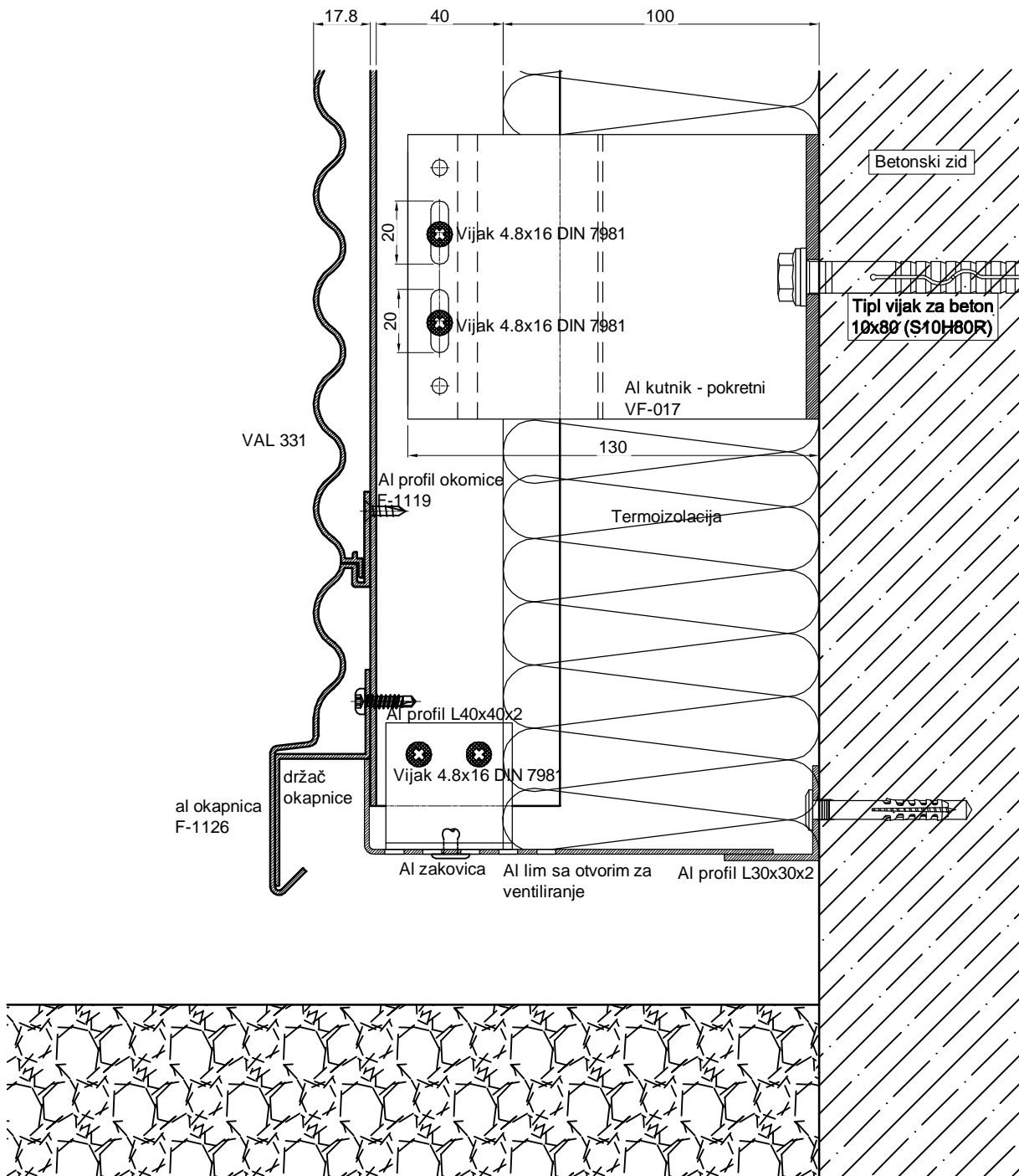



VAL 331
-obrade i montaža-

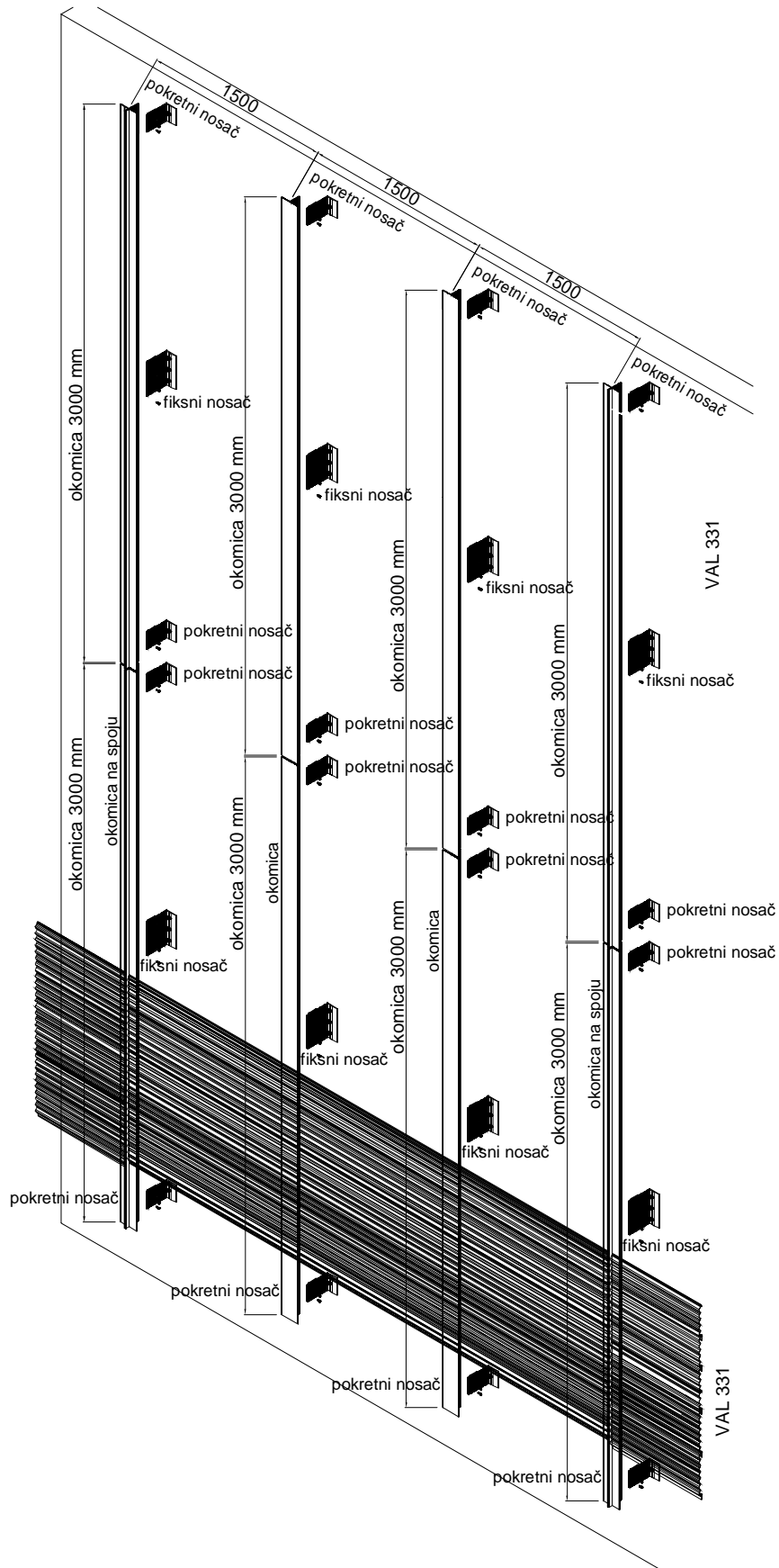

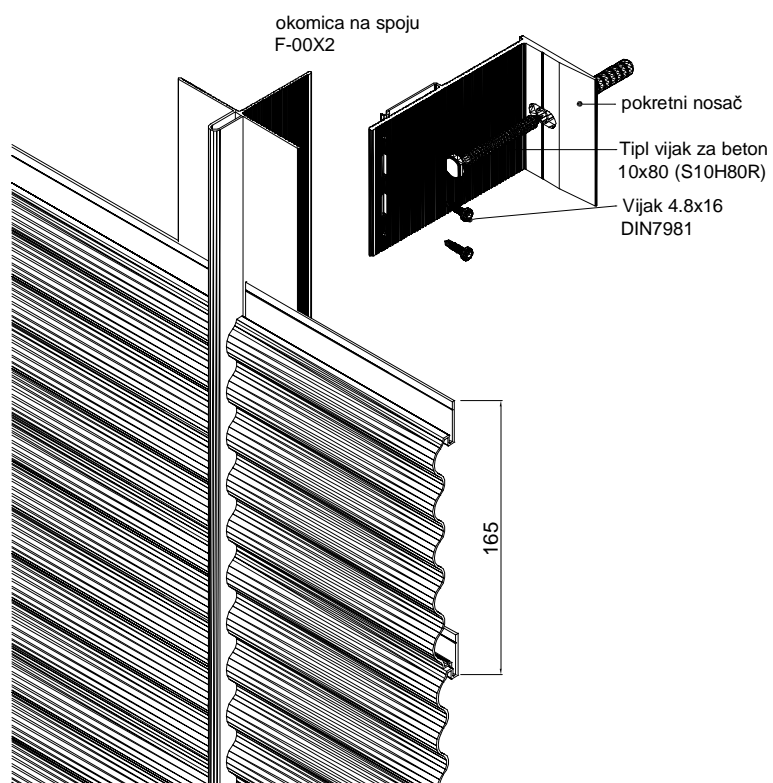
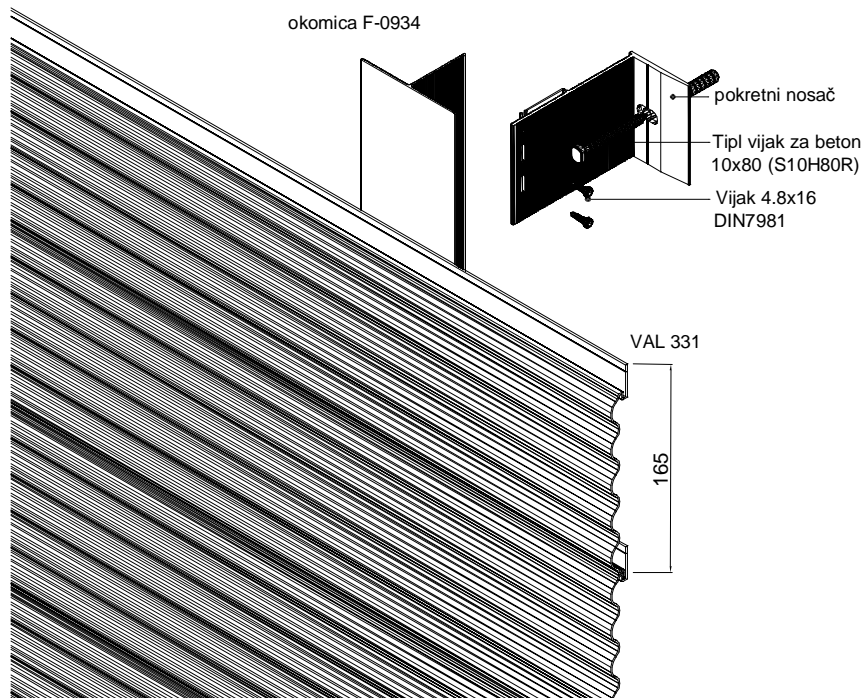

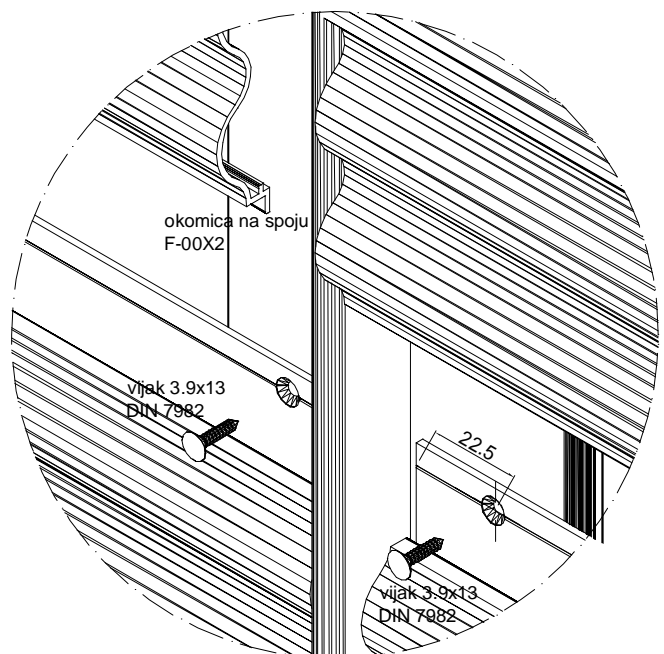
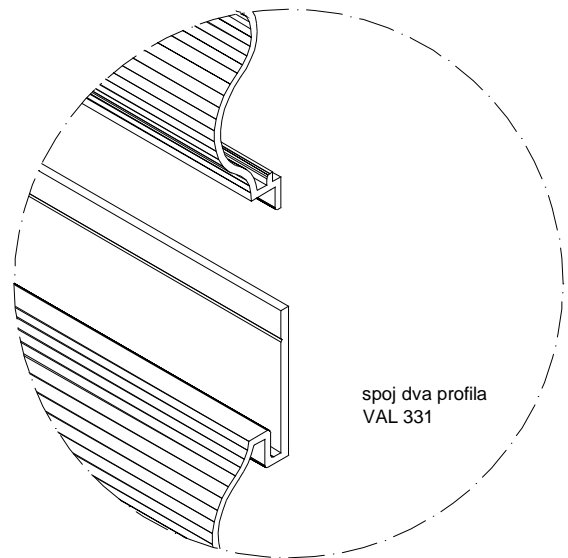
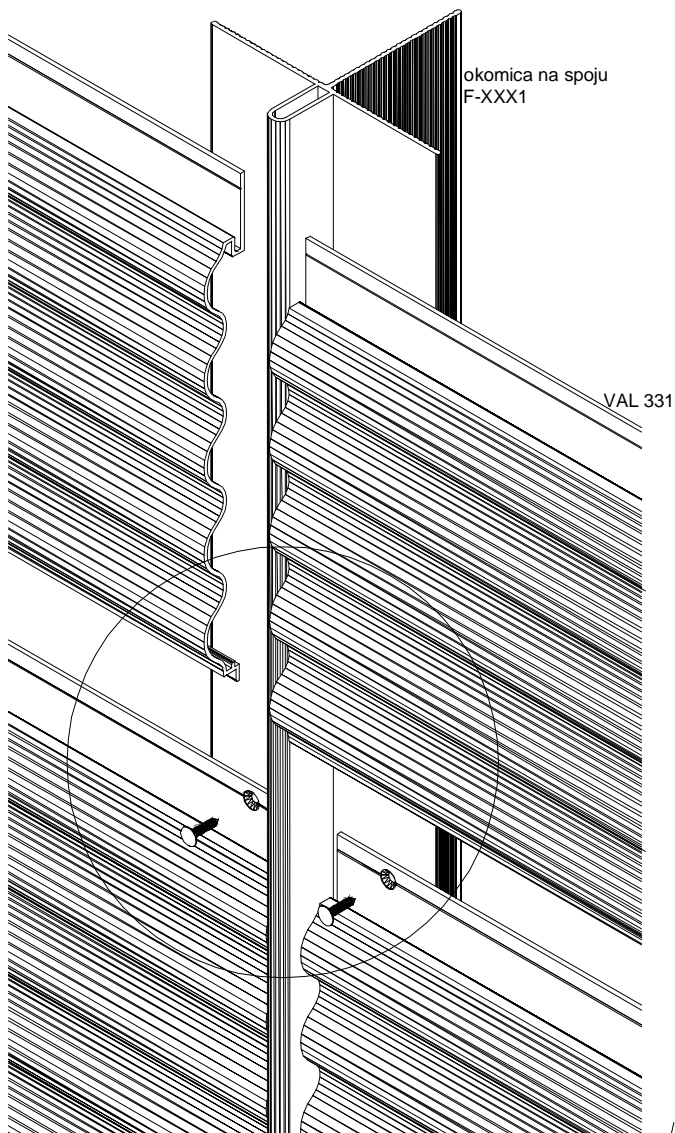

pričvršćivanje profila VAL331 za okomicu

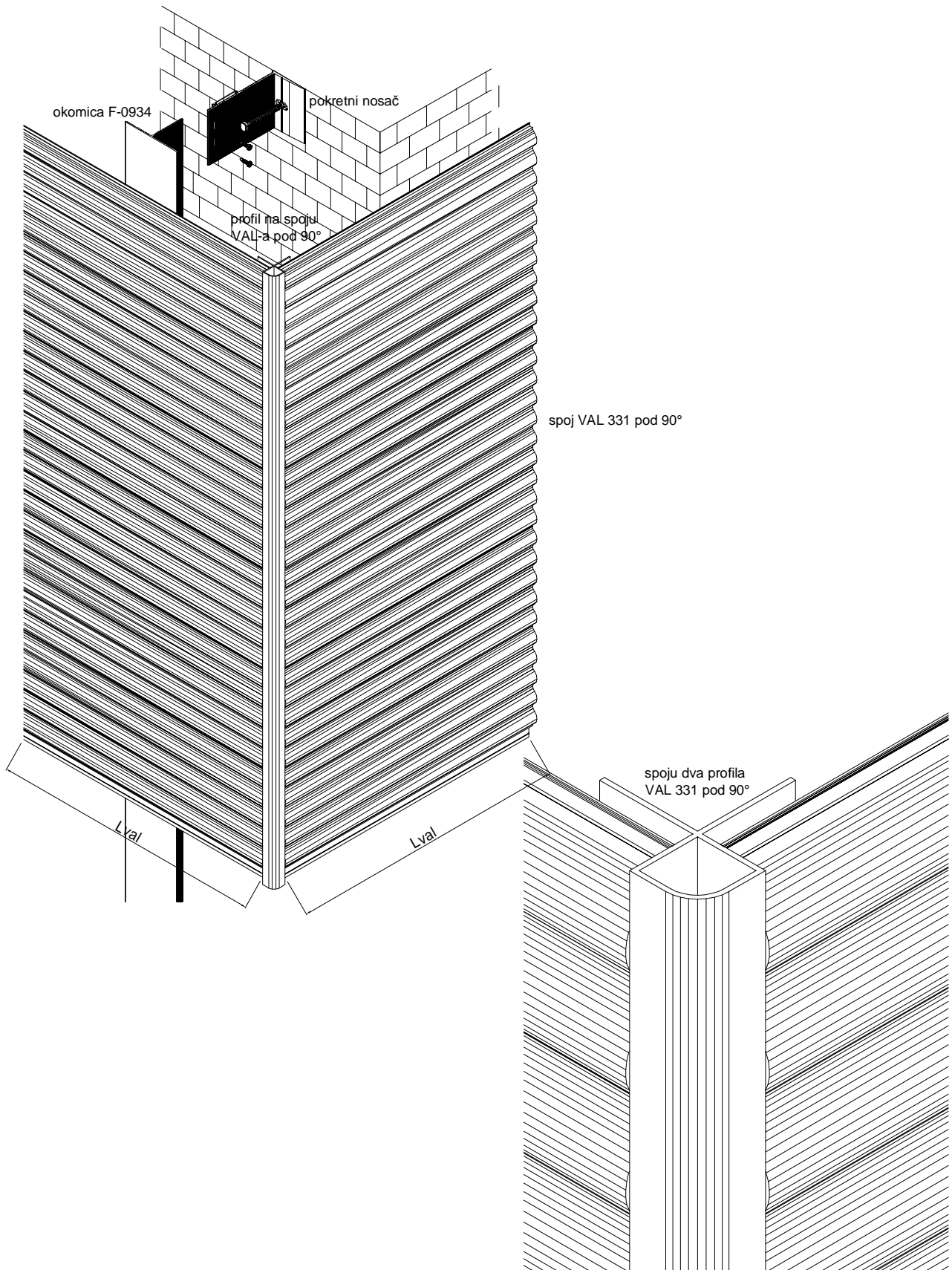

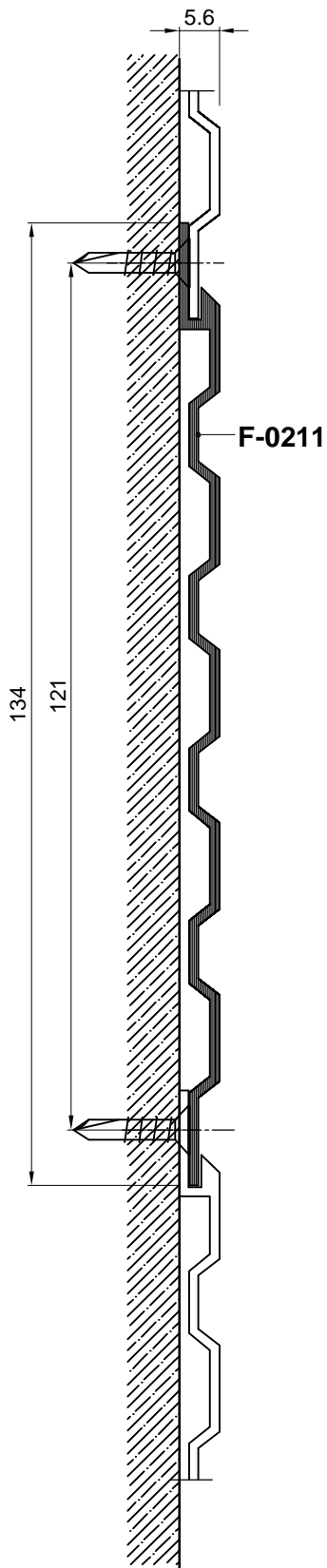

F-0211	0.580 kg/m
	4.79 kg/m ²

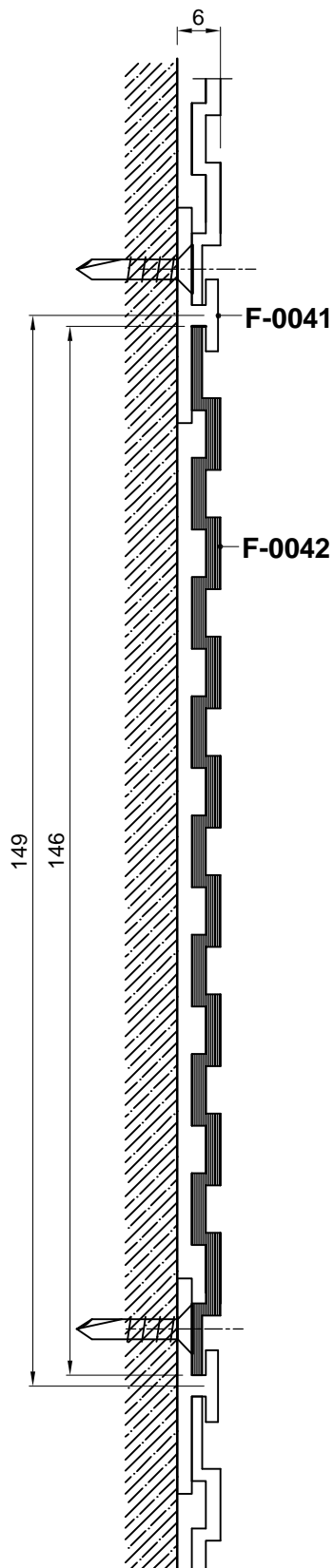

F-0042	0.910 kg/m
	6.23 kg/m ²
F-0041	0.229 kg/m
	1.57 kg/m ²

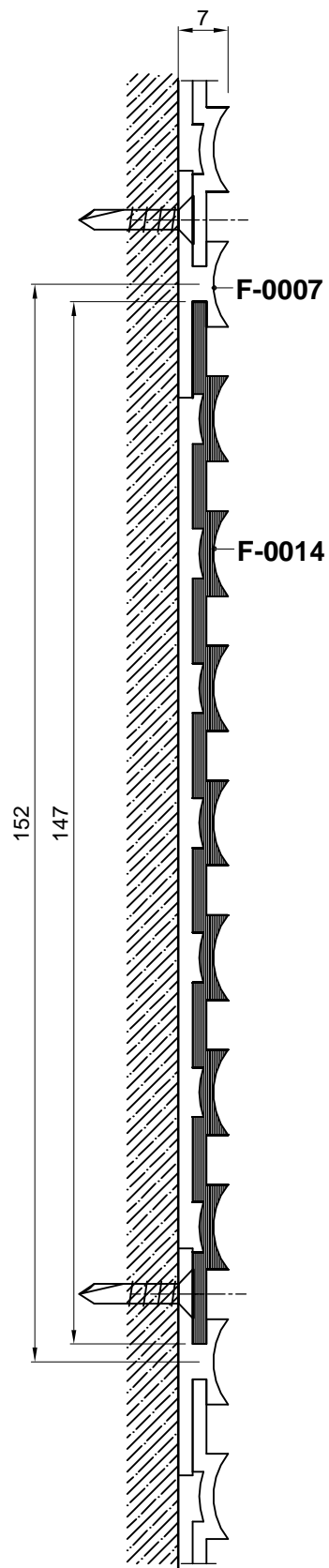

F-0014	0.973 kg/m
	6.62 kg/m ²
F-0007	0.250 kg/m
	1.7 kg/m ²

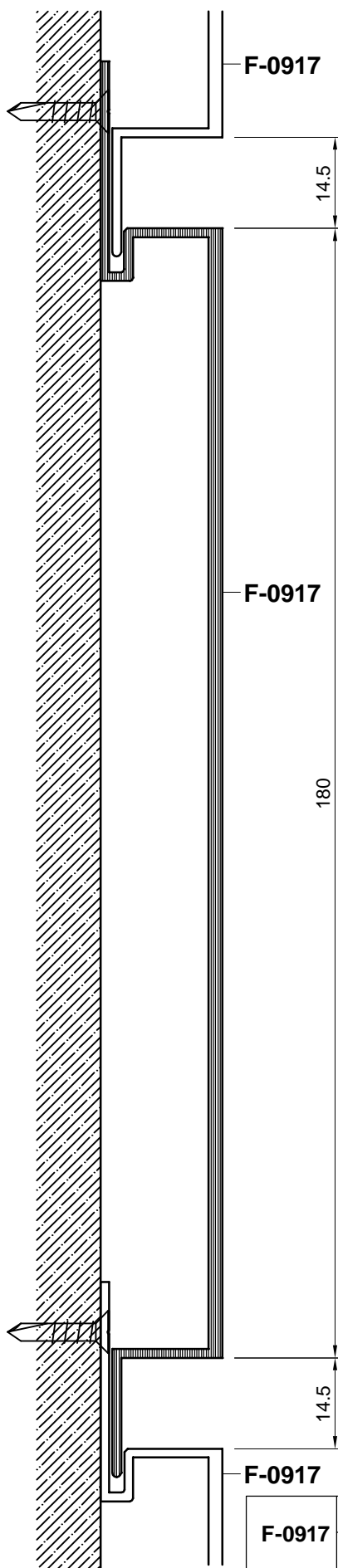

F-0917	1.41 kg/m
	7.05 kg/m ²

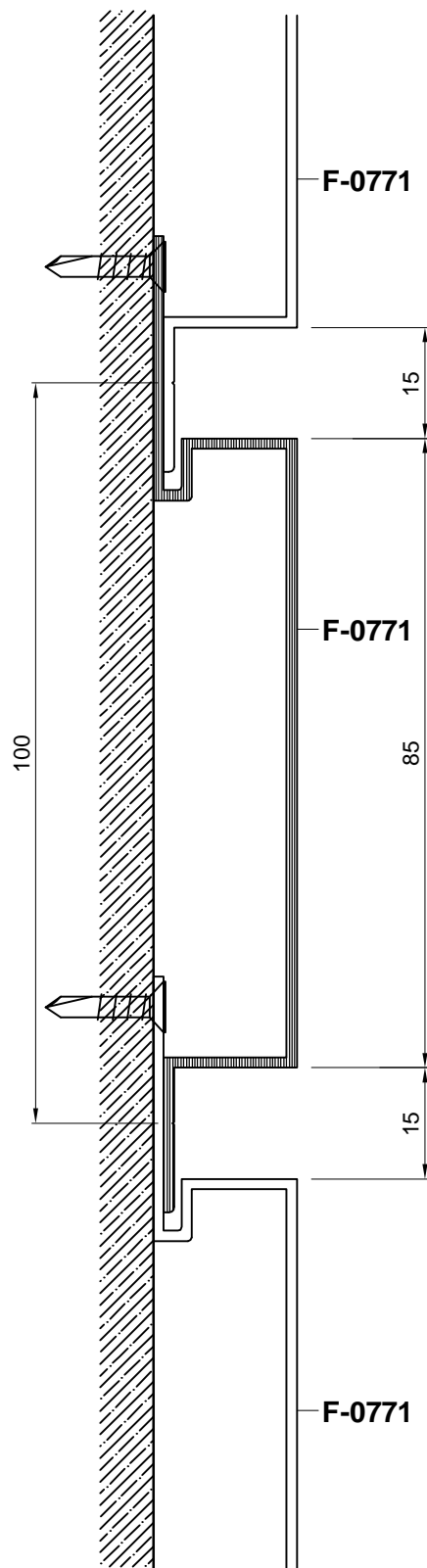

F-0771	0.68 kg/m
	6.8 kg/m ²

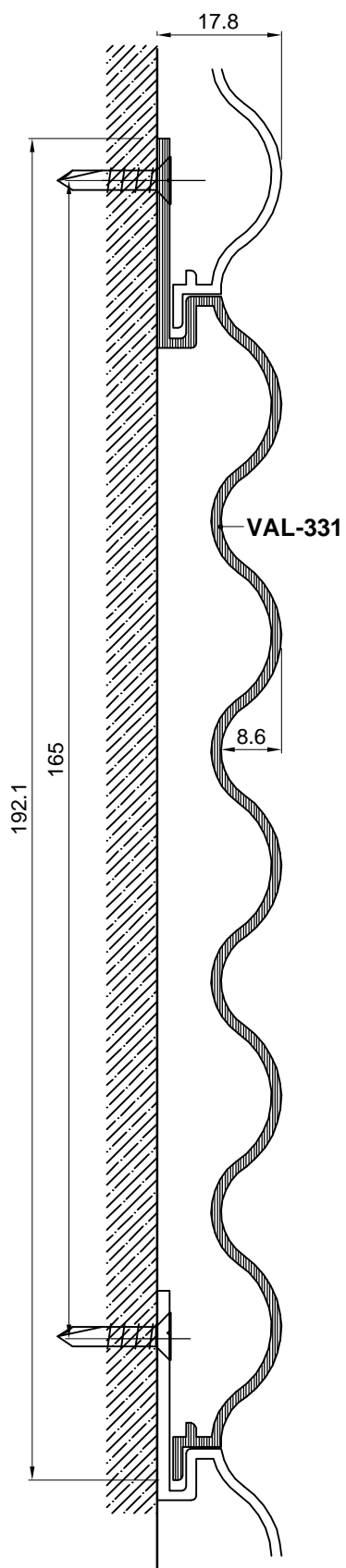

VAL-331	0.970 kg/m
	5.879 kg/m ²

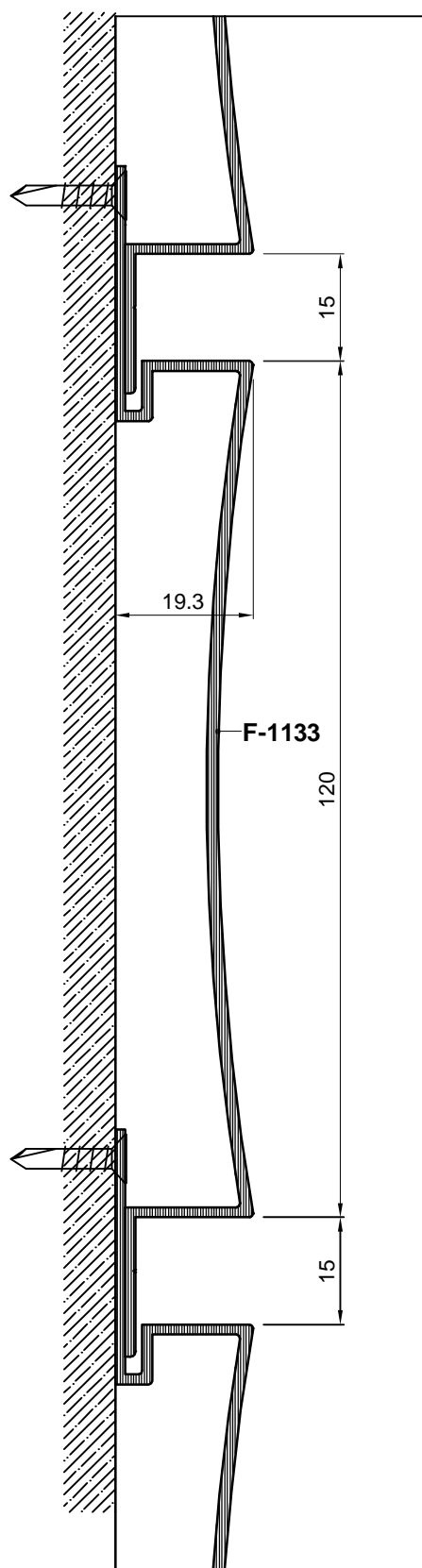

F-1133	0.878 kg/m
	6.14

